

N625P422582
N605P438648

Product manual
Gebrauchsanweisung
Manuel du produit
Manual del producto
Manuale del prodotto

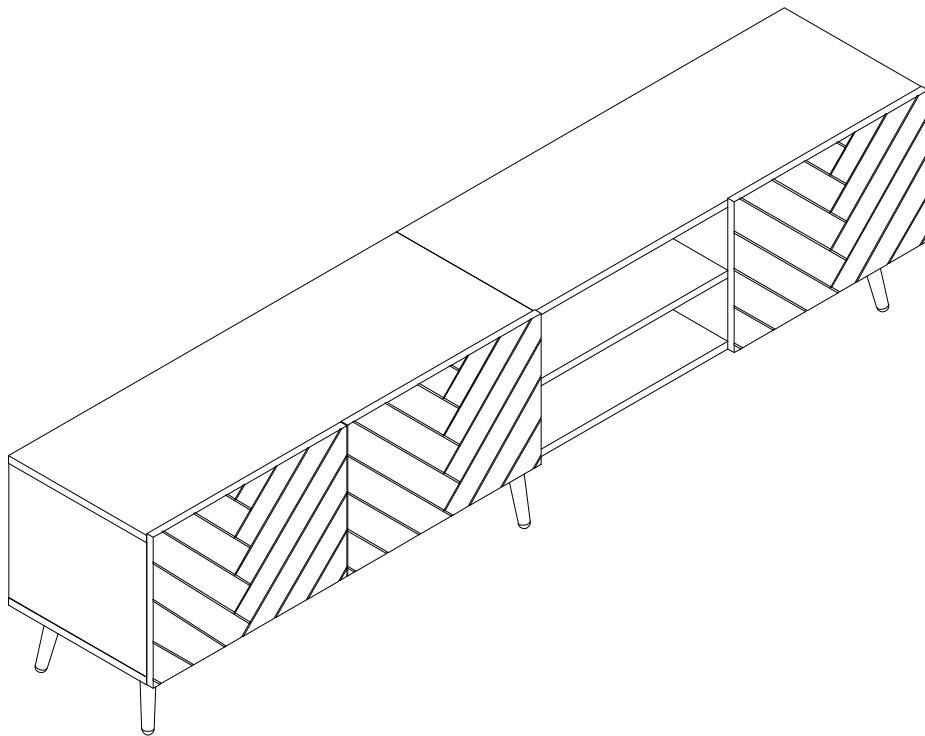



FR

 Pensez à donner ou recycler.

 Association *ou*  Magasin *ou*  Déchèterie

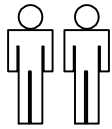
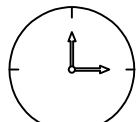
<https://quefairedemesdechets.fr>

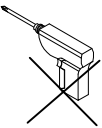
 2PERS	 60MIN	Tool Required 	Not Provided 
--	---	---	--



[DE]

Warnung: Lesen Sie diese Anleitung vor dem Zusammenbau bitte vollständig durch. Überprüfen Sie, ob Sie alle auf den Seiten aufgeführten Komponenten und Werkzeuge haben. Bewahren Sie die Anleitung zum späteren Nachschlagen auf. Teile des Zusammenbaus lassen sich mit 2 Personen leichter durchführen. Suchen Sie bei Bedarf professionelle Hilfe.

Warnung: Legen Sie alle Teile auf eine ebene Fläche. Legen Sie eine weiche Decke oder Ähnliches darunter, um sie vor Kratzern oder Flecken zu schützen. Vermeiden Sie es, Komponenten über den Boden zu ziehen oder zu schieben.

Warnung: Überprüfen Sie regelmäßig alle Beschläge und Befestigungen, um sicherzustellen, dass sie sicher sind und um Unfälle zu vermeiden. Wenn Teile fehlen, kaputt, beschädigt oder abgenutzt sind, verwenden Sie das Produkt nicht weiter, bis es mit vom Hersteller autorisierten Teilen repariert wurde.

Warnung: Lassen Sie Kinder nicht auf die Möbel klettern, da dies zum Umkippen und zu schweren Verletzungen führen kann. Bauen Sie die Möbel außerhalb der Reichweite von Kindern zusammen.

Warnung: Stellen Sie die Möbel nicht in die Nähe von Feuerquellen oder heißen Gegenständen, um Brandgefahr zu vermeiden.

Warnung: Reinigen Sie die Möbel mit einem feuchten Tuch oder Alkohol. Verwenden Sie keine Reinigungsmittel mit ätzenden Chemikalien.

Warnung: Dieses Produkt ist mit einer Kippschutzvorrichtung ausgestattet. Bitte installieren Sie diese Vorrichtung unbedingt, um unnötige Verletzungen durch Umkippen zu vermeiden.

[EN]

Warning: Please read these instructions fully before starting assembly. Check you have all the components and tools listed on pages. Keep the instructions for later reference. Parts of the assembly will be easier with 2 people. Seek professional assistance if necessary.

Warning: Please place all parts on a flat surface. Place a soft blanket or similar underneath to protect against scratches or stains. Avoid dragging or sliding components across the floor.

Warning: Regularly check all fittings and fastenings to ensure they are secure and to prevent accidents. If any parts are missing, broken, damaged, or worn, discontinue use of the product until repairs have been made using factory authorized parts.

Warning: Do not allow children to climb on the furniture as this may result in tipping and serious personal injury. Assemble the furniture away from the reach of children.

Warning: Do not place furniture close to fire sources or high-temperature objects to avoid the risk of fire. Do not place furniture in damp environments to prevent material damage.

Warning: Clean furniture with a damp cloth or alcohol, avoid using cleaning agents containing corrosive chemicals.

Warning: This product is equipped with an anti-tilt device. Please be sure to install this device to prevent unnecessary injuries caused by tipping.

[FR]

Avertissement : Veuillez lire attentivement ces instructions avant de commencer l'assemblage. Vérifiez que vous disposez de tous les composants et outils répertoriés sur les pages. Conservez les instructions pour référence ultérieure. Certaines parties de l'assemblage seront plus faciles à 2 personnes. Demandez l'aide d'un professionnel si nécessaire.

Avertissement : Veuillez placer toutes les pièces sur une surface plane. Placez une couverture douce ou similaire en dessous pour les protéger des rayures ou des taches. Évitez de faire glisser les composants sur le sol.

Avertissement : Vérifiez régulièrement tous les raccords et fixations pour vous assurer qu'ils sont bien fixés et

pour éviter les accidents. Si des pièces manquent, sont cassées, endommagées ou usées, cessez d'utiliser le produit jusqu'à ce que des réparations aient été effectuées à l'aide de pièces autorisées par l'usine.

Avertissement : Ne laissez pas les enfants grimper sur les meubles car cela pourrait entraîner un basculement et des blessures graves. Assemblez les meubles hors de portée des enfants.

Avertissement : Ne placez pas les meubles à proximité de sources de feu ou d'objets à haute température pour éviter tout risque d'incendie.

Avertissement : Nettoyez les meubles avec un chiffon humide ou de l'alcool, évitez d'utiliser des produits de nettoyage contenant des produits chimiques corrosifs.

Avertissement : Ce produit est équipé d'un dispositif anti-basculement. Assurez-vous d'installer ce dispositif pour éviter les blessures inutiles causées par un basculement.

[IT]

Attenzione: leggere attentamente queste istruzioni prima di iniziare il montaggio. Verificare di avere tutti i componenti e gli strumenti elencati nelle pagine. Conservare le istruzioni per riferimento futuro. Alcune parti del montaggio saranno più facili con 2 persone. Se necessario, chiedere assistenza professionale.

Attenzione: posizionare tutte le parti su una superficie piana. Posizionare una coperta morbida o simile sotto per proteggere da graffi o macchie. Evitare di trascinare o far scivolare i componenti sul pavimento.

Attenzione: controllare regolarmente tutti i raccordi e i dispositivi di fissaggio per assicurarsi che siano sicuri e per prevenire incidenti. Se alcune parti sono mancanti, rotte, danneggiate o usurate, interrompere l'uso del prodotto fino a quando non siano state eseguite le riparazioni utilizzando parti autorizzate dalla fabbrica.

Attenzione: non consentire ai bambini di arrampicarsi sui mobili poiché ciò potrebbe causare ribaltamenti e gravi lesioni personali. Montare i mobili lontano dalla portata dei bambini.

Attenzione: non posizionare i mobili vicino a fonti di fuoco o oggetti ad alta temperatura per evitare il rischio di incendio

Attenzione: pulire i mobili con un panno umido o alcol, evitare di utilizzare detergenti contenenti sostanze chimiche corrosive.

Attenzione: questo prodotto è dotato di un dispositivo antiribaltamento. Assicurarsi di installare questo dispositivo per prevenire lesioni inutili causate dal ribaltamento.

[ES]

Advertencia: Lea estas instrucciones completamente antes de comenzar el montaje. Compruebe que tiene todos los componentes y herramientas que se enumeran en las páginas. Conserve las instrucciones para consultarlas más adelante. El montaje de algunas partes será más sencillo con 2 personas. Busque ayuda profesional si es necesario.

Advertencia: Coloque todas las piezas sobre una superficie plana. Coloque una manta suave o algo similar debajo para protegerlas de rayones o manchas. Evite arrastrar o deslizar los componentes por el piso.

Advertencia: Verifique regularmente todos los accesorios y fijaciones para asegurarse de que estén seguros y evitar accidentes. Si falta alguna pieza, está rota, dañada o desgastada, deje de usar el producto hasta que se hayan realizado las reparaciones con piezas autorizadas de fábrica.

Advertencia: No permita que los niños se suban a los muebles, ya que esto puede provocar que se vuelquen y lesiones personales graves. Monte los muebles fuera del alcance de los niños.

Advertencia: No coloque los muebles cerca de fuentes de fuego u objetos de alta temperatura para evitar el riesgo de incendio.

Advertencia: Limpie los muebles con un paño húmedo o alcohol, evite usar agentes de limpieza que contengan químicos corrosivos.

Advertencia: Este producto está equipado con un dispositivo antivuelco. Asegúrese de instalar este dispositivo para evitar lesiones innecesarias causadas por vuelcos.

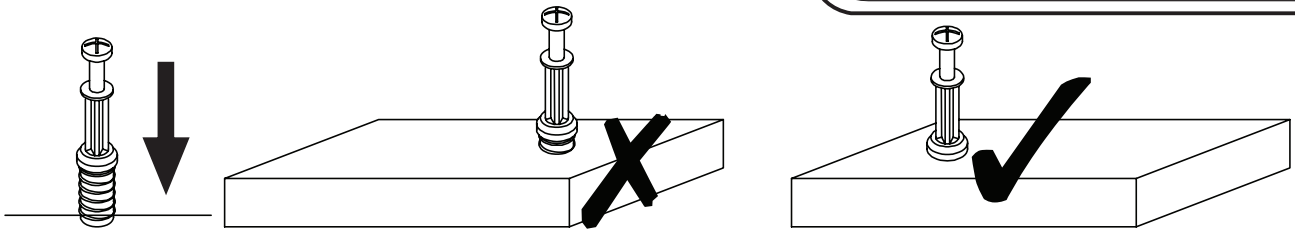

EN_QUICKFIT: Tighten quickfit until shoulder is flush with panel. Do not overtighten or undertighten.

FR_RACCORD RAPIDE: Faites serrer le raccord rapide jusqu'à ce que l'épaulement soit parfaitement encastré dans le panneau. Il ne faut ni trop serrer ni insuffisamment serrer.

ES_QUICKFIT: Apriete quickfit hasta que el hombro se descargue con el panel. NO lo sobreapriete ni lo apriete poco.

DE_QUICKFIT: Ziehen Sie den Quickfit fest, bis die Schulter mit der Platte bündig ist. Bitte nicht zu fest oder zu schwach anziehen.

IT_MONTAGGIO RAPIDO: Stringere il montaggio rapido fino a quando la spalla è a filo con il pannello, non stringere troppo o troppo poco.

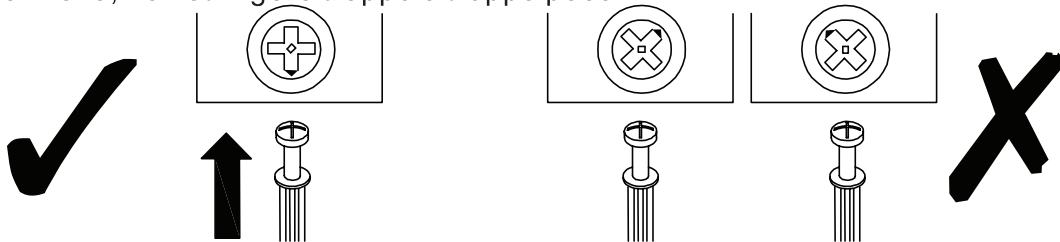

EN_CAM LOCK: When fitting cam lock, ensure starting position is correct before you insert connecting quickfit.

FR_SERRURE BATTEUSE: Avant d'insérer la serrure batteuse, veillez à la bonne orientation avant d'insérer le raccord rapide.

ES_CIERRE DE LA CÁMARA: Cuando instale el cierre de la cámara, asegúrese de que la posición de inicio es correcta antes de que inserte el quickfit conector.

DE_CAM-LOCK: Achten Sie bei der Montage des Cam-Locks auf die richtige Ausgangsposition, bevor Sie den Quickfit einsetzen.

IT_BLOCCAGGIO A CAMMA: Quando si monta il bloccaggio a camma, assicurarsi che la posizione iniziale sia corretta prima di inserire il montaggio rapido di collegamento.

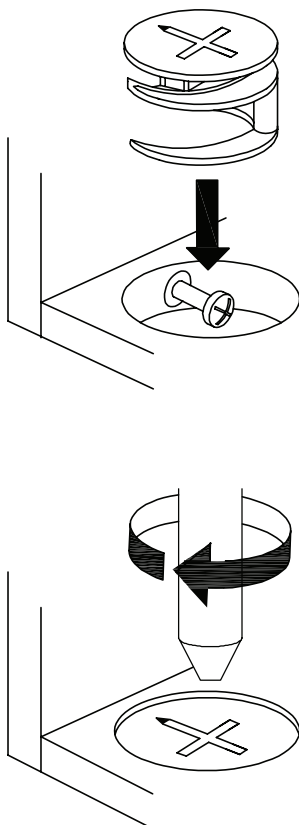

EN_Quickfit head should be in the centre of the cam lock when the two panels are joined.

Cam lock should be inserted before quickfit.

FR_Lorsque les deux panneaux sont assemblés, la tête du raccord rapide doit reposer au centre de la serrure batteuse. Il faut insérer la serrure batteuse avant le raccord rapide.

ES_El cabezal del quickfit debe estar en el centro del cierre de la cámara cuando se unan los dos paneles.

Se debe insertar el cierre de la cámara antes que el quickfit.

DE_Der Quickfit-Kopf sollte sich in der Mitte des Cam-Locks befinden, wenn die beiden Platten zusammengefügt sind. Der Cam-Lock sollte vor dem Quickfit eingesetzt werden.

IT_La testa del montaggio rapido deve trovarsi al centro del bloccaggio a camma quando i due pannelli sono uniti.

Il Bloccaggio a Camma deve essere inserito prima del montaggio rapido.

EN_Turn cam lock clockwise to tighten.

FR_Faites tourner la serrure batteuse dans le sens des aiguilles d'une montre pour la resserrer.

ES_Gire el cierre de la cámara en sentido horario para apretarlo.

DE_Drehen Sie den Cam-Lock im Uhrzeigersinn, um ihn festzuziehen.

IT_Ruotare il bloccaggio a camma in senso orario per stringere.

EN_It may be necessary to adjust the hinges so that the doors align. Use the instructions below as a guide.

FR_Il est parfois nécessaire d'ajuster les charnières pour un meilleur alignement des portes. Servez-vous des instructions ci-dessous comme guide.

ES_Puede que sea necesario ajustar los quicios de forma que se alineen las puertas. Use las instrucciones que aparecen debajo como guía.

DE_Möglicherweise müssen Sie die Scharniere so einstellen, dass die Türen ausgerichtet sind. Verwenden Sie die nachstehenden Anweisungen als Leitfaden.

IT_Potrebbe essere necessario regolare le cerniere in modo che le porte siano allineate. Per fare ciò attenersi alle istruzioni sottostanti.

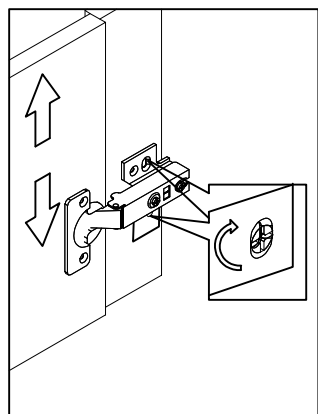

EN_To adjust the door vertically loosen the screw as shown and move up and down as needed.

FR_Si vous souhaitez régler la porte verticalement, desserrez la vis comme indiqué et déplacez la porte de haut en bas selon les besoins.

ES_Para ajustar la puerta verticalmente afloje el tornillo tal y como se muestra y muévalo hacia arriba o hacia abajo según sea necesario.

DE_Um die Tür vertikal auszurichten, lösen Sie die Schraube wie abgebildet und bewegen Sie sie nach Bedarf nach oben oder nach unten.

IT_Per allineare la porta verticalmente allentare la vite come mostrato e spostarla in alto o in basso secondo necessità.

EN_To adjust the gap from the door to the main frame turn the screw clockwise or anti-clockwise as needed.

FR_Si vous souhaitez ajuster l'ecart entre la porte et le cadre principal, tournez la vis dans le sens des aiguilles d'une montre ou dans le sens inverse, si nécessaire.

ES_Para ajustar el espacio desde la puerta al marco principal, gire el tornillo en sentido horario o antihorario según se necesite.

DE_Um den Abstand von der Tür zum Hauptrahmen auszurichten, drehen Sie die Schraube je nach Bedarf im oder gegen den Uhrzeigersinn.

IT_Per regolare lo spazio tra la porta e il telaio principale, avvitare o svitare la vite secondo necessità.

EN_To adjust the door laterally adjust the screw as shown by turning clockwise or anti-clockwise.

FR_Si vous souhaitez ajuster la porte latéralement, ajustez la vis comme indiqué en tournant dans le sens des aiguilles d'une montre ou dans le sens inverse des aiguilles d'une montre.

ES_Para ajustar la puerta lateralmente ajuste el tornillo tal y como se muestra girándolo en sentido horario y antihorario.

DE_Um die Tür seitlich auszurichten, stellen Sie bitte die Schraube wie abgebildet durch Drehen im oder gegen den Uhrzeigersinn ein.

IT_Per allineare la porta lateralmente regolare la vite come mostrato, avvitandola o svitandola

EN_Please fix other screws

FR_Merci de serrer les autres vis

ES_Fije los demás tornillos

DE_Befestigen Sie bitte die anderen Schrauben IT_Fissare le altre viti

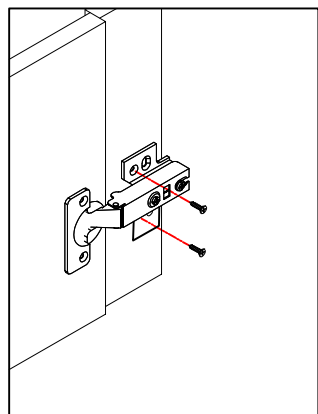

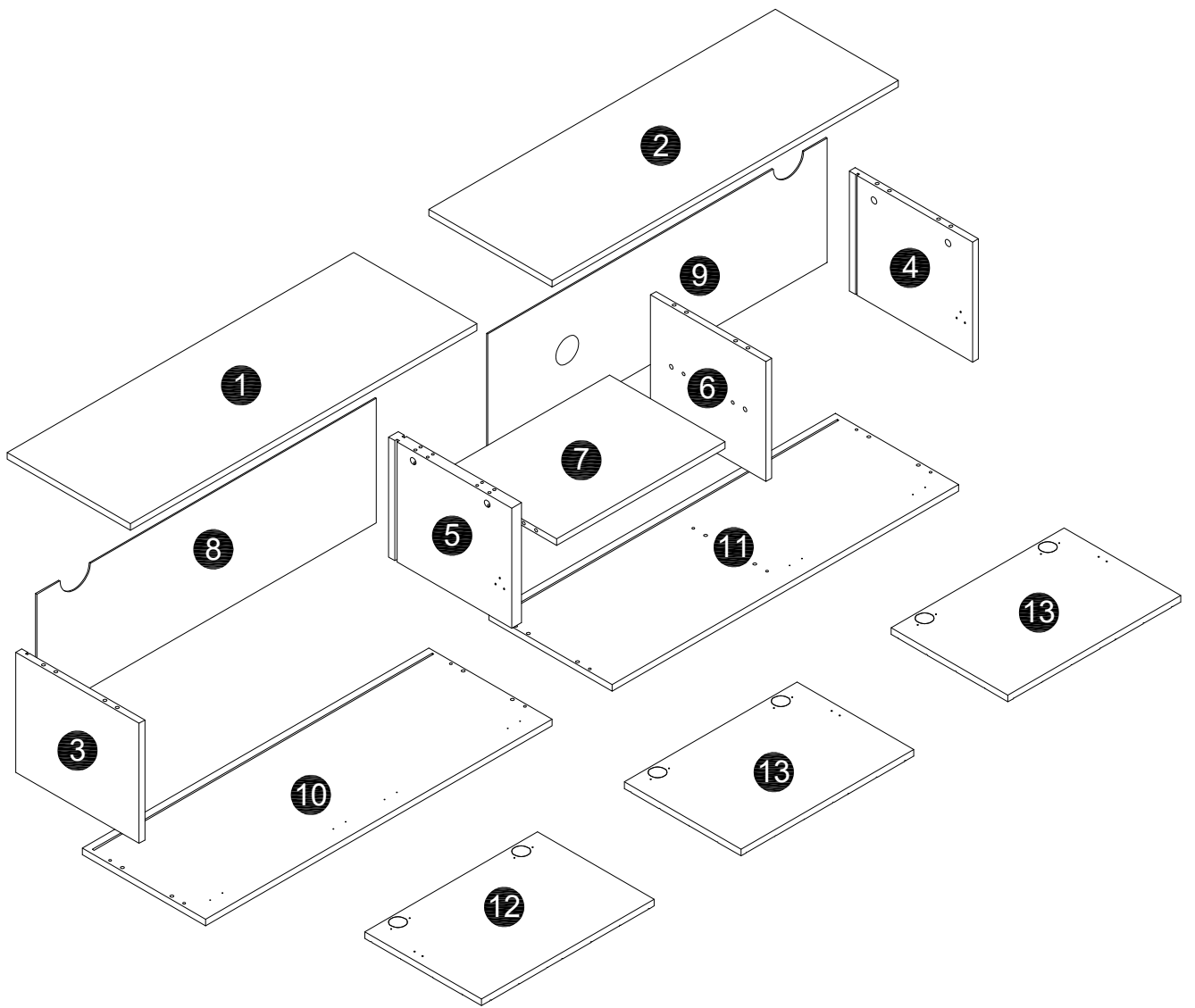



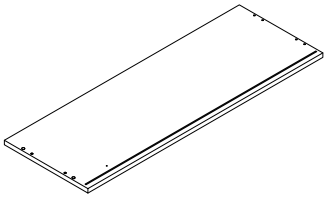
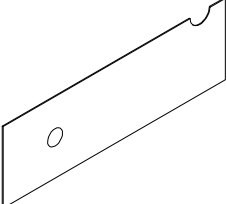
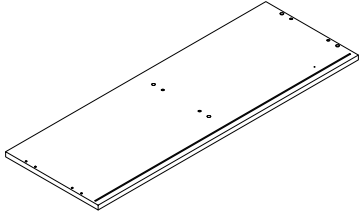
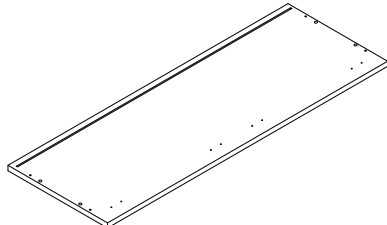
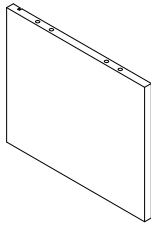
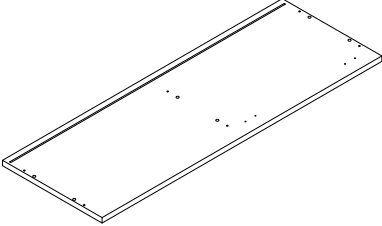
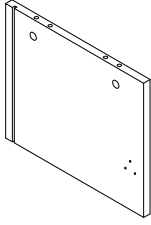
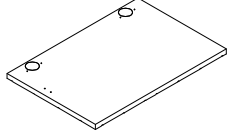
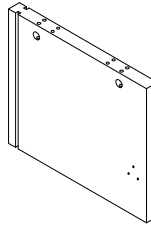
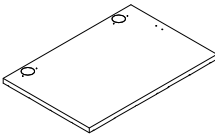
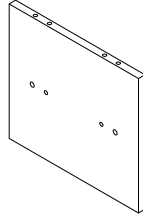
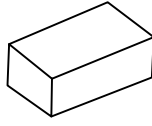
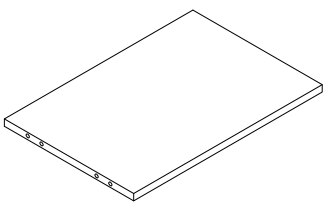
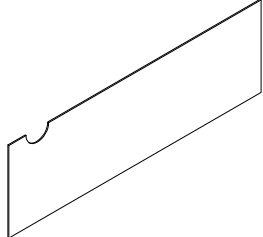



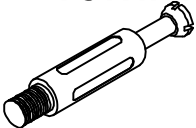

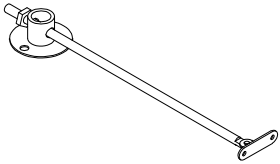

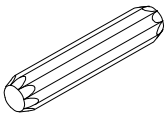
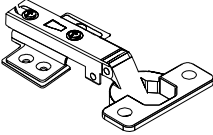

N625P422582/N605P438648

NO.	QTY	NO.	QTY
<p>①</p> 	1PC	<p>⑨</p> 	1PC
<p>②</p> 	1PC	<p>⑩</p> 	1PC
<p>③</p> 	1PC	<p>⑪</p> 	1PC
<p>④</p> 	1PC	<p>⑫</p> 	1PC
<p>⑤</p> 	1PC	<p>⑬</p> 	2PCS
<p>⑥</p> 	1PC	<p>Hardware</p> 	
<p>⑦</p> 	1PC		
<p>⑧</p> 	1PC		

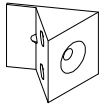
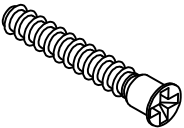
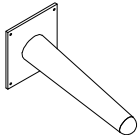
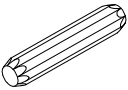
N625P422582/N605P438648

<p>A</p> <p>40mm</p>  <p>15*12</p>  <p>10PCS</p>	<p>H</p>  <p>3PCS</p>
<p>B</p> <p>28mm</p>  <p>15*10</p>  <p>4PCS</p>	<p>L</p>  <p>L1</p>  <p>L2</p>  <p>L3</p> <p>2SET</p>
<p>C</p>  <p>8*40</p> <p>16PCS</p>	<p>M</p>  <p>6PCS</p>
<p>D</p>  <p>3.5*14</p> <p>89PCS</p>	<p>N</p>  <p>12PCS</p>
<p>E</p>  <p>5*40</p> <p>10PCS</p>	<p>P</p>  <p>6PCS</p>
<p>F</p>  <p>6*30</p> <p>8PCS</p>	
<p>G</p>  <p>14PCS</p>	

1

- D 3.5*14
2PCS
- L1
2PCS

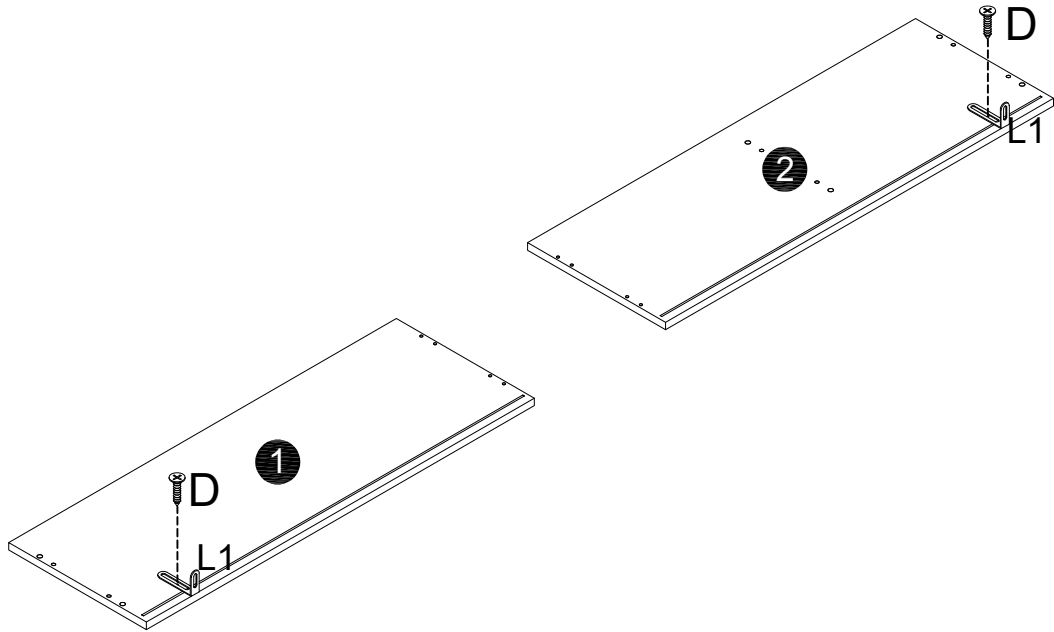

2

- A 10PCS
- B 4PCS

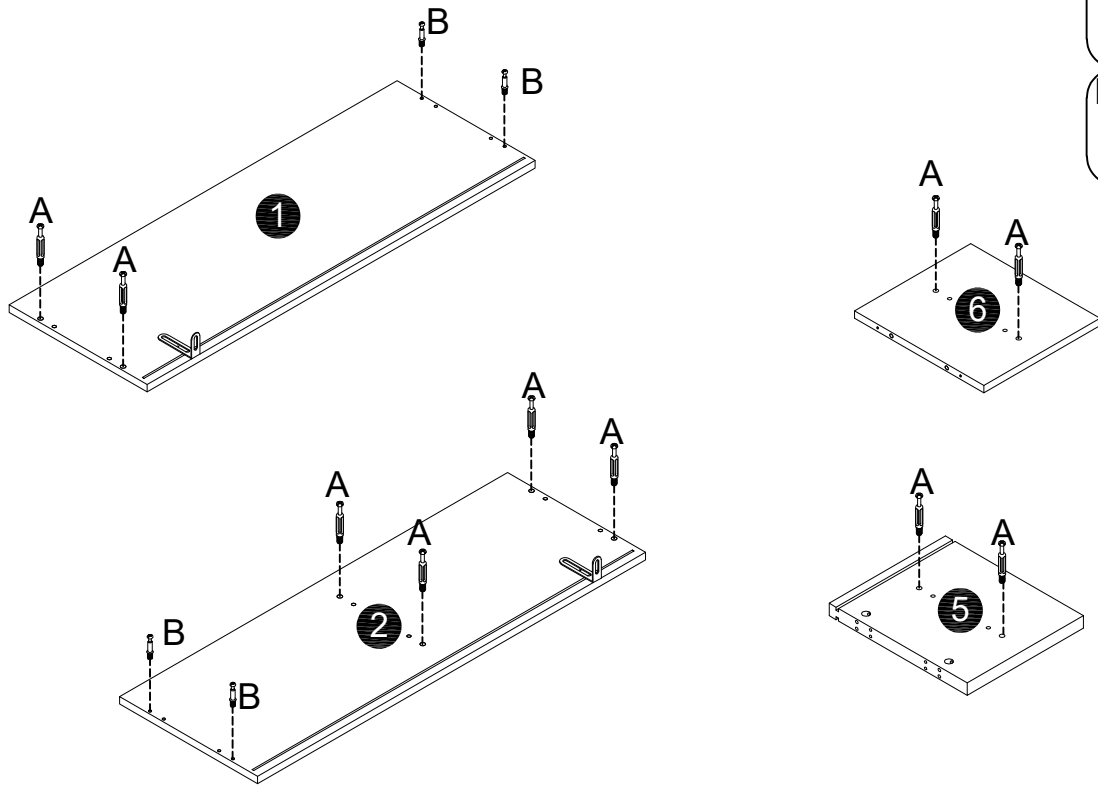

3

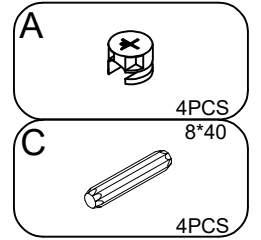
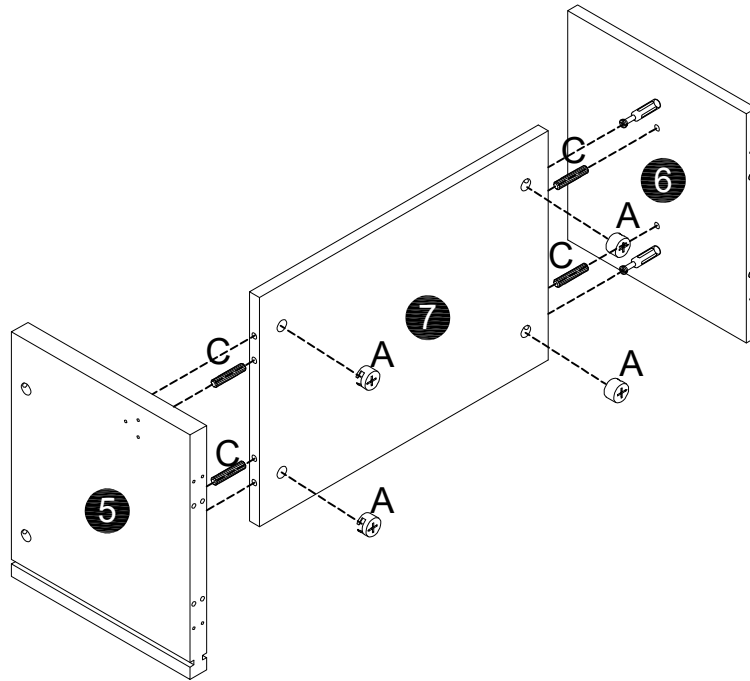
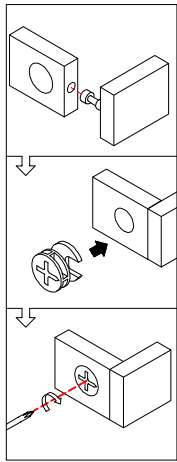

4

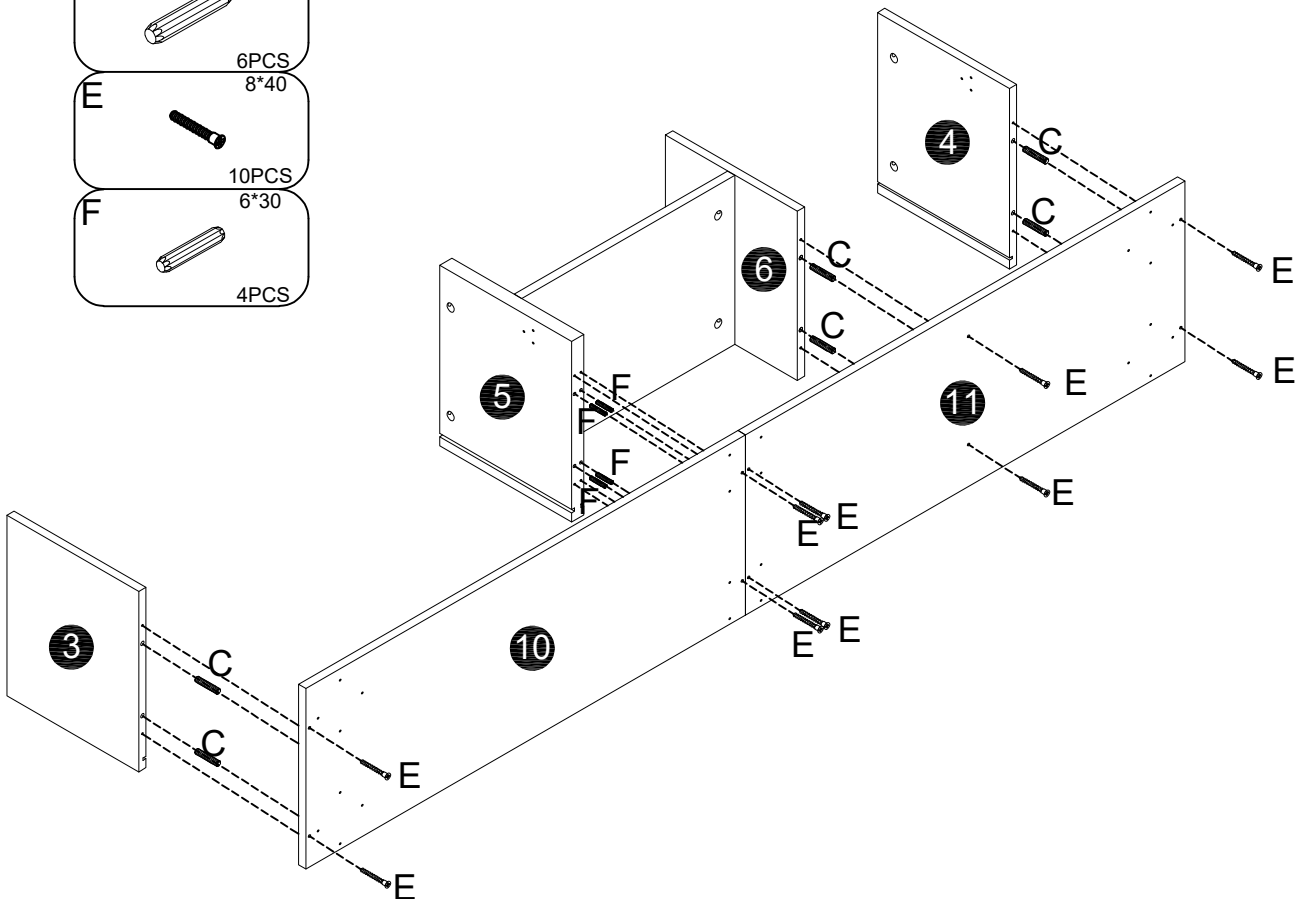
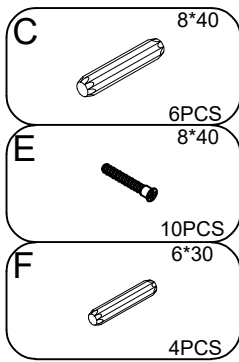

5

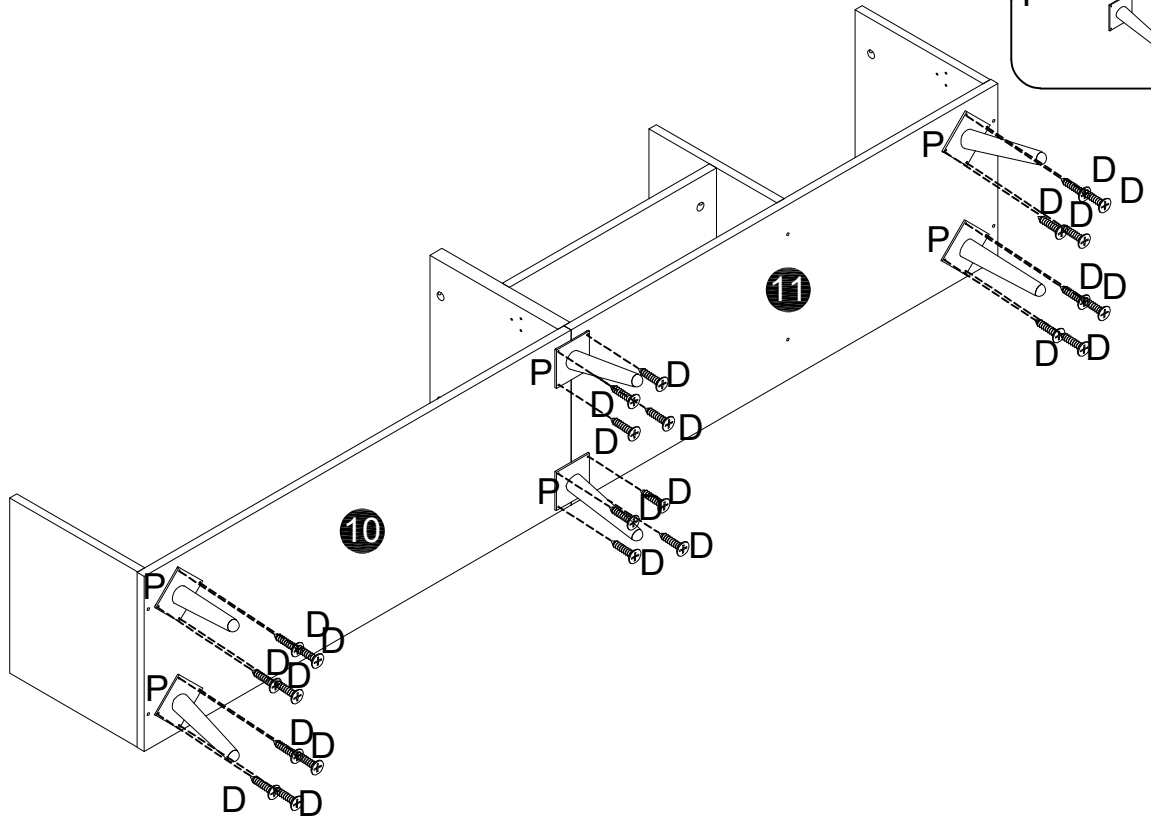
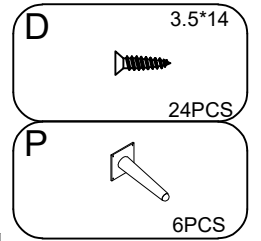



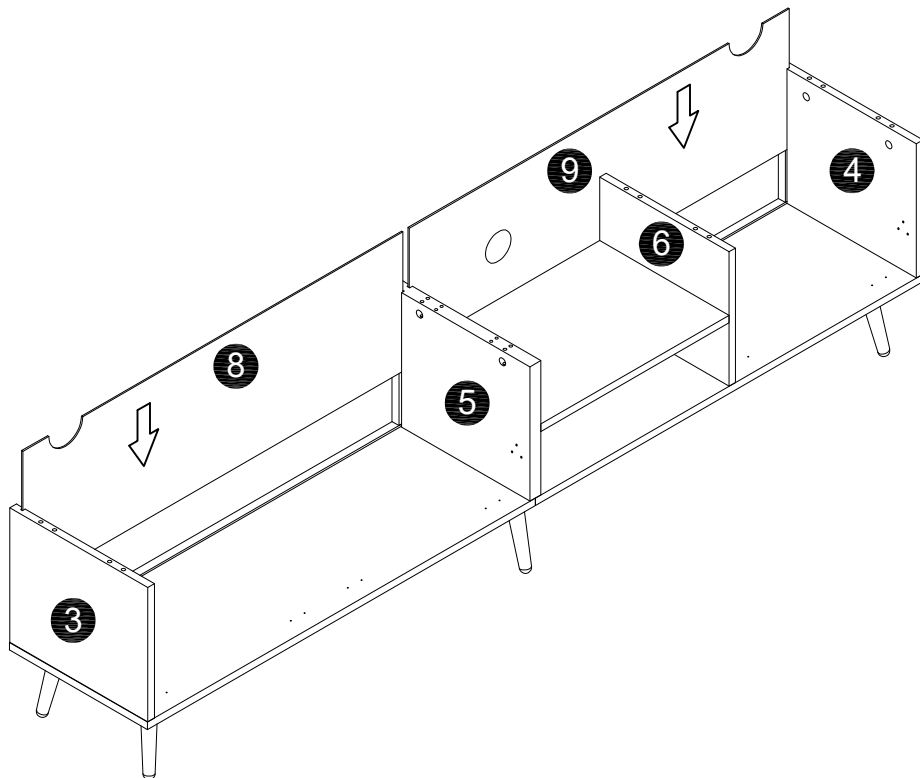

6

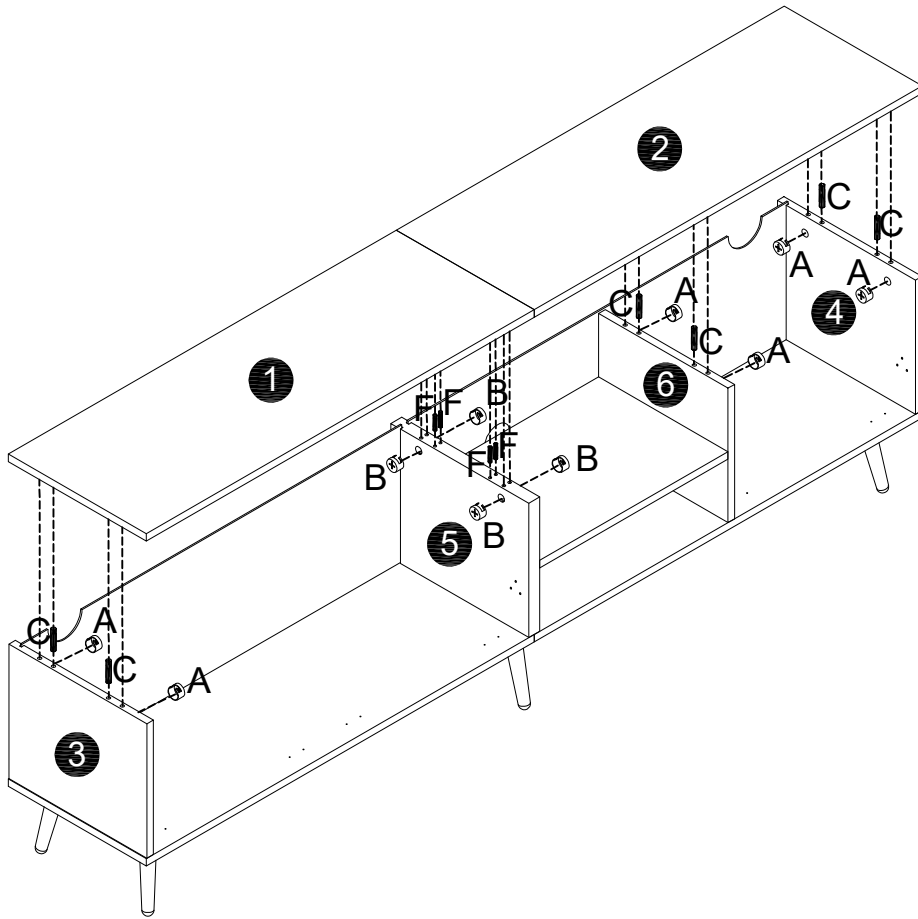
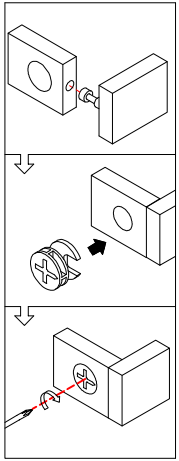



7

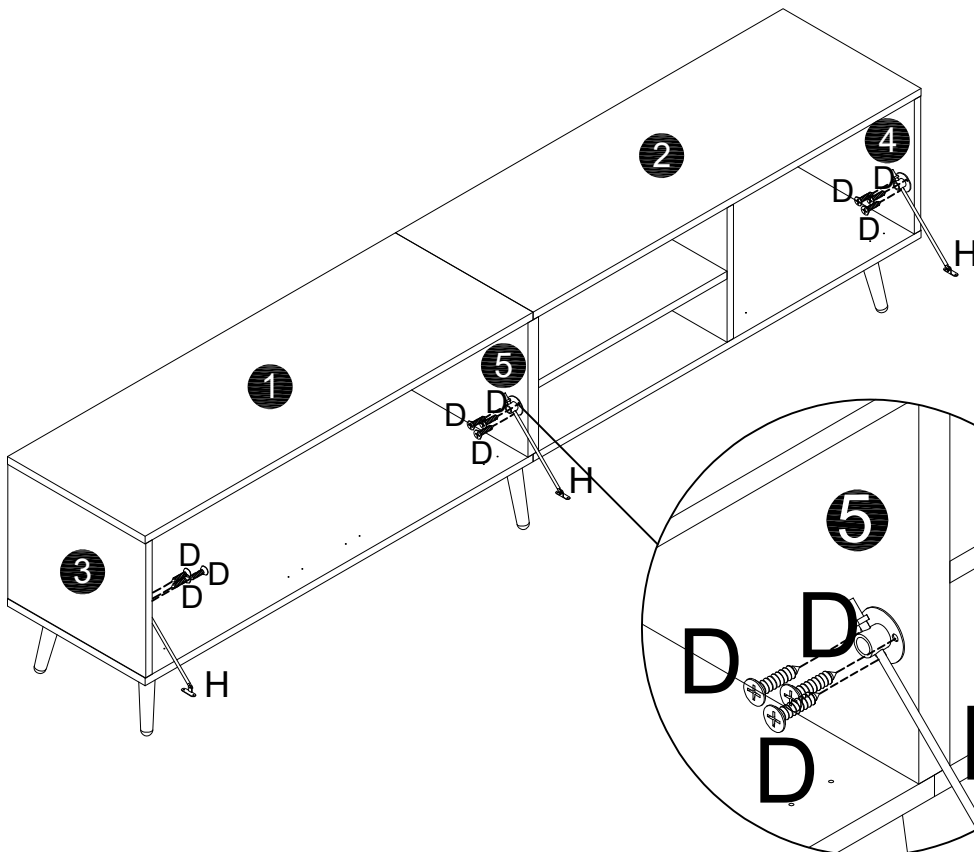

- A 15*12

6PCS
- B 15*10

4PCS
- C 8*40

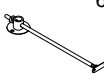
6PCS
- F 6*30

4PCS

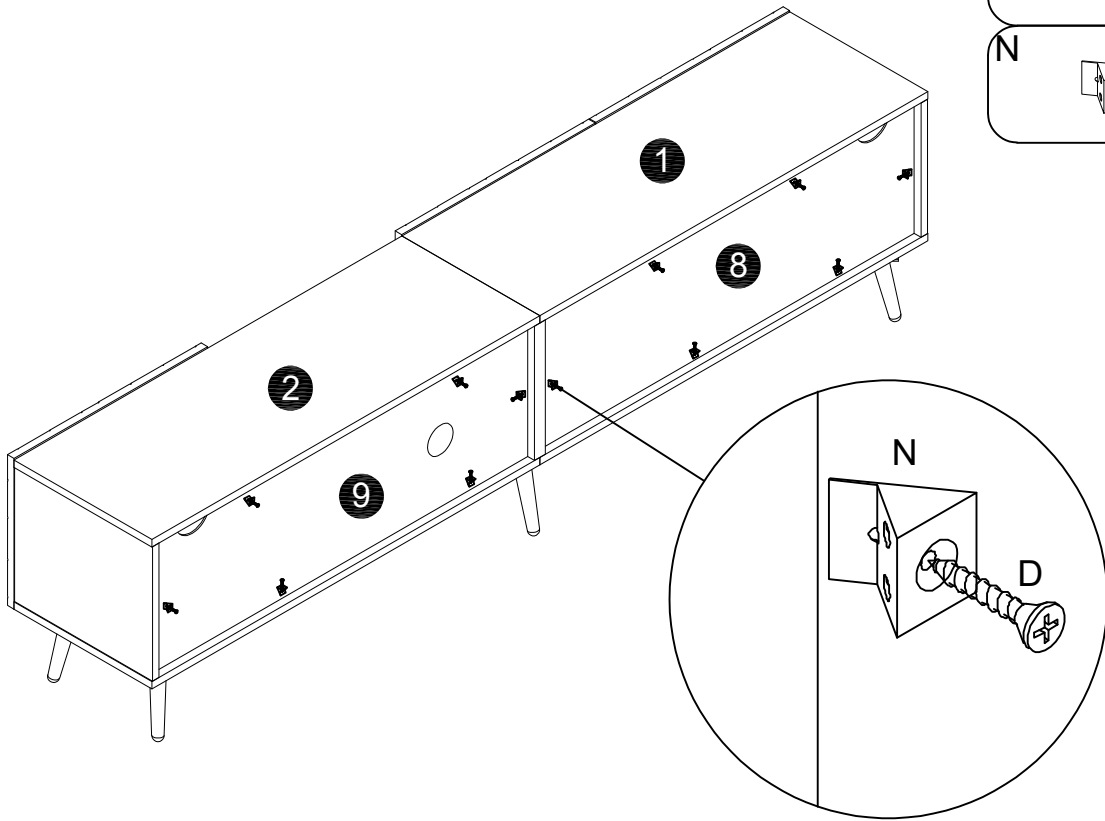
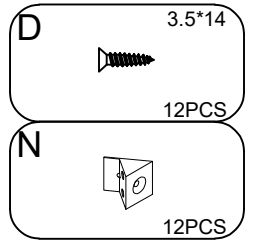
8



- D 3.5*14

9PCS
- H 6*30

3PCS

9



10

