

Installation Manual

YGD01

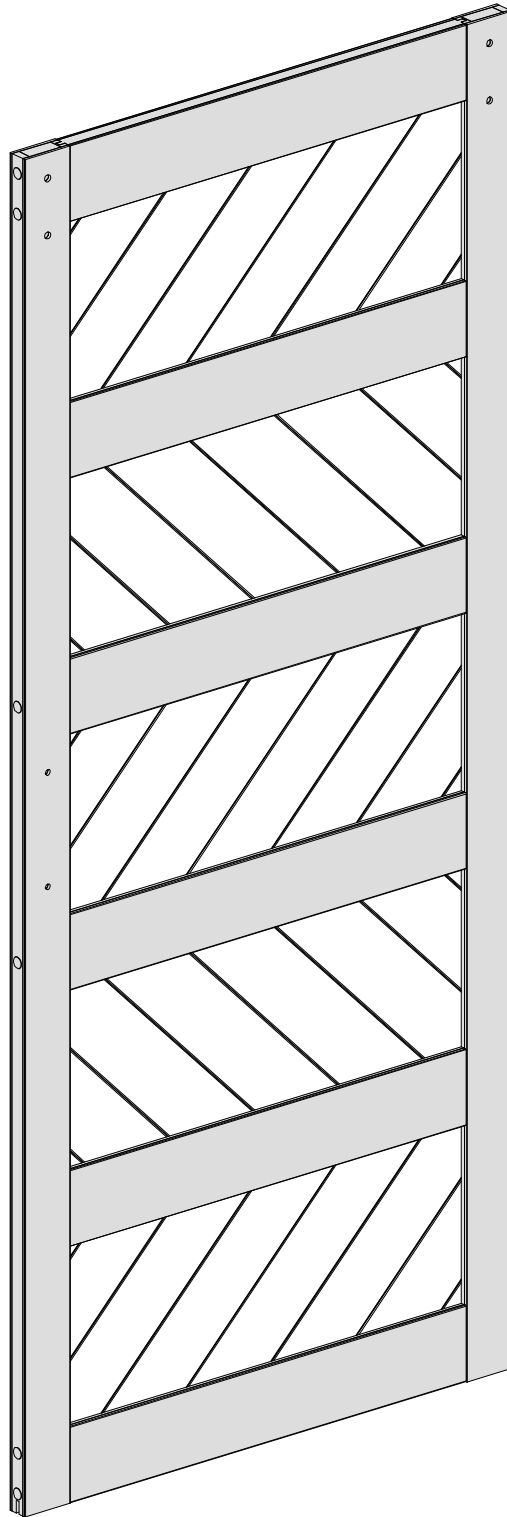

INSTRUCTIONS

Package List		
A1A2	Side Stile	*2
B1	Top Rail	*1
B2	Rail with 2 different holes	*2
B3	Rail with 2 same holes	*2
B4	Bottom Rail	*1
C	Corks	*8
D	Carriage Bolt	*12
E	Plastic Cap	*12
F	Washer	*12
G	Middle Slat	*5

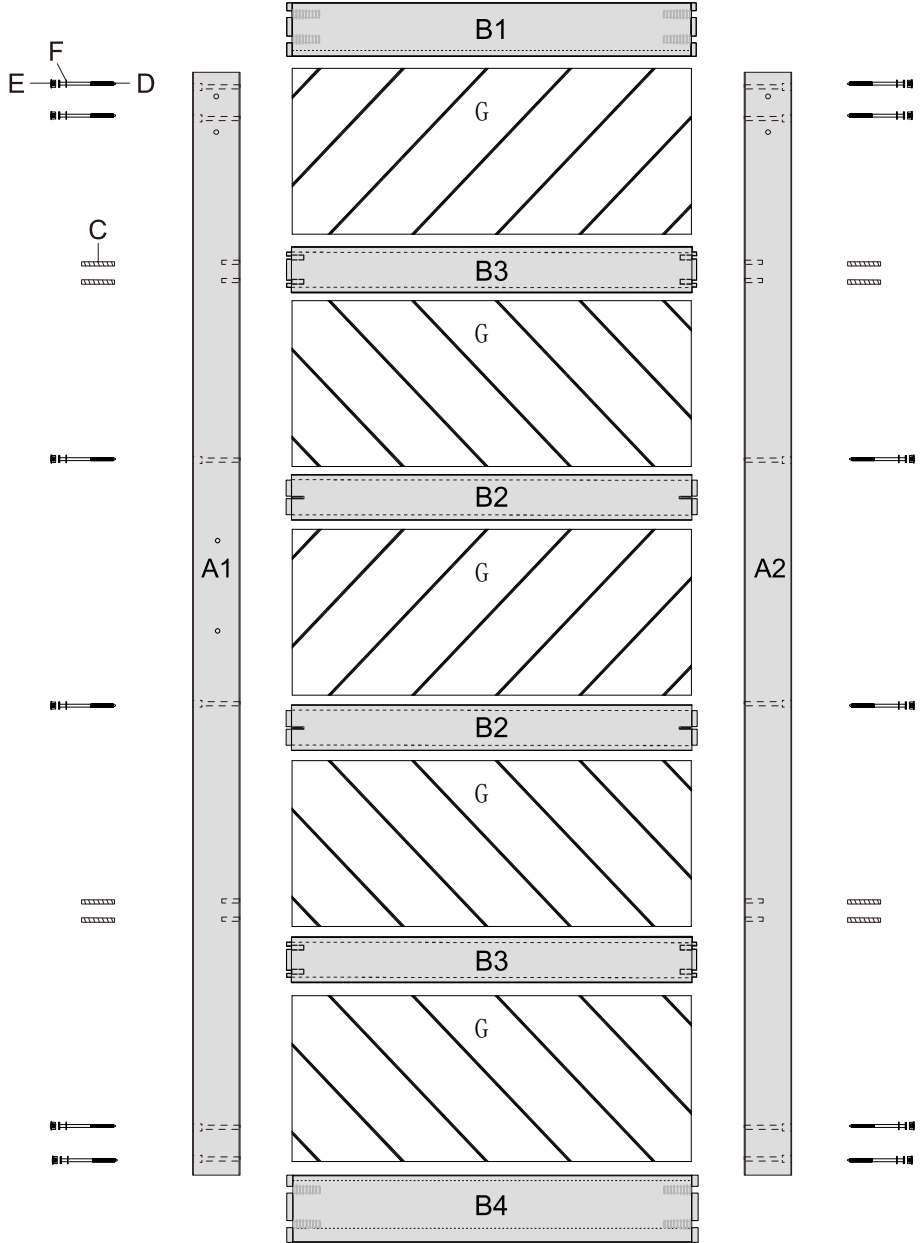
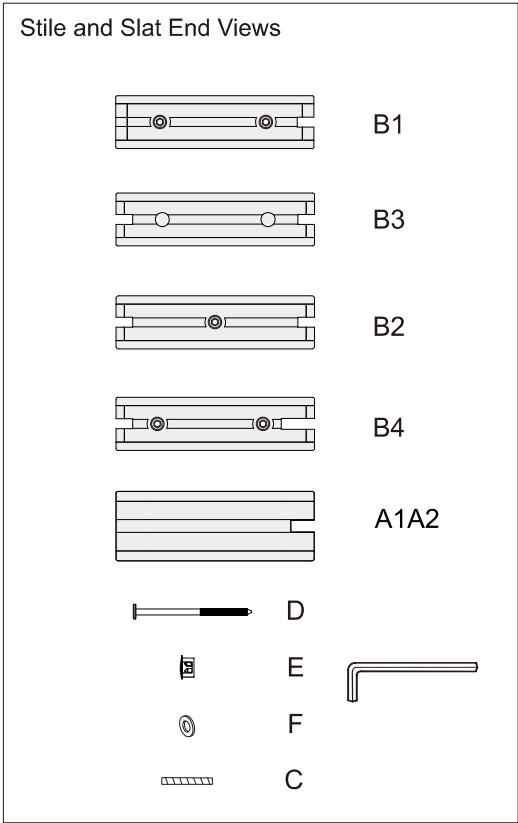

To provide feedback on a particular part, please mark it by circling in the instruction manual and kindly send us a photo.

Step 1.

Attach B1 Top Rail to one Side Stile A2 using two carriage bolts and one wood plug.
Then attach B4 Bottom Rail using two carriage bolts.

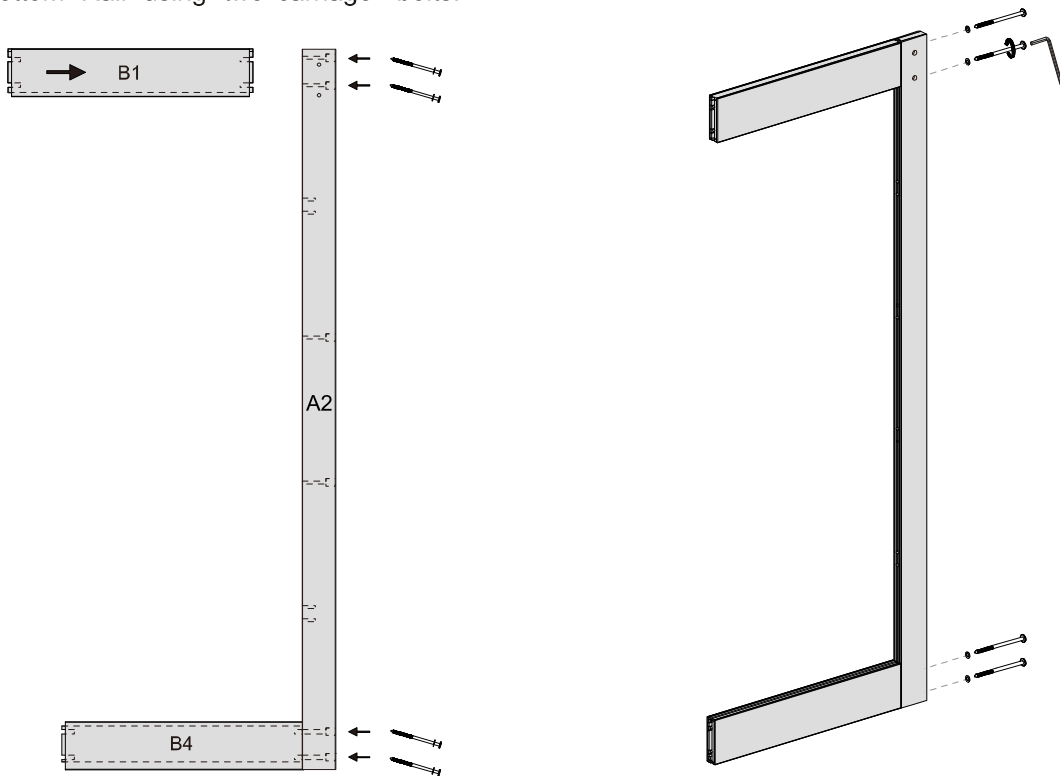

Step 2.

Connect each Rail B2 to Side Stile A2 using one wood plug and one carriage bolt.
Connect each Rail B3 to Side Stile A2 using two wood plugs.
Make sure each Rail of **B1,B2,B3** and B4 tightly connected with A2.

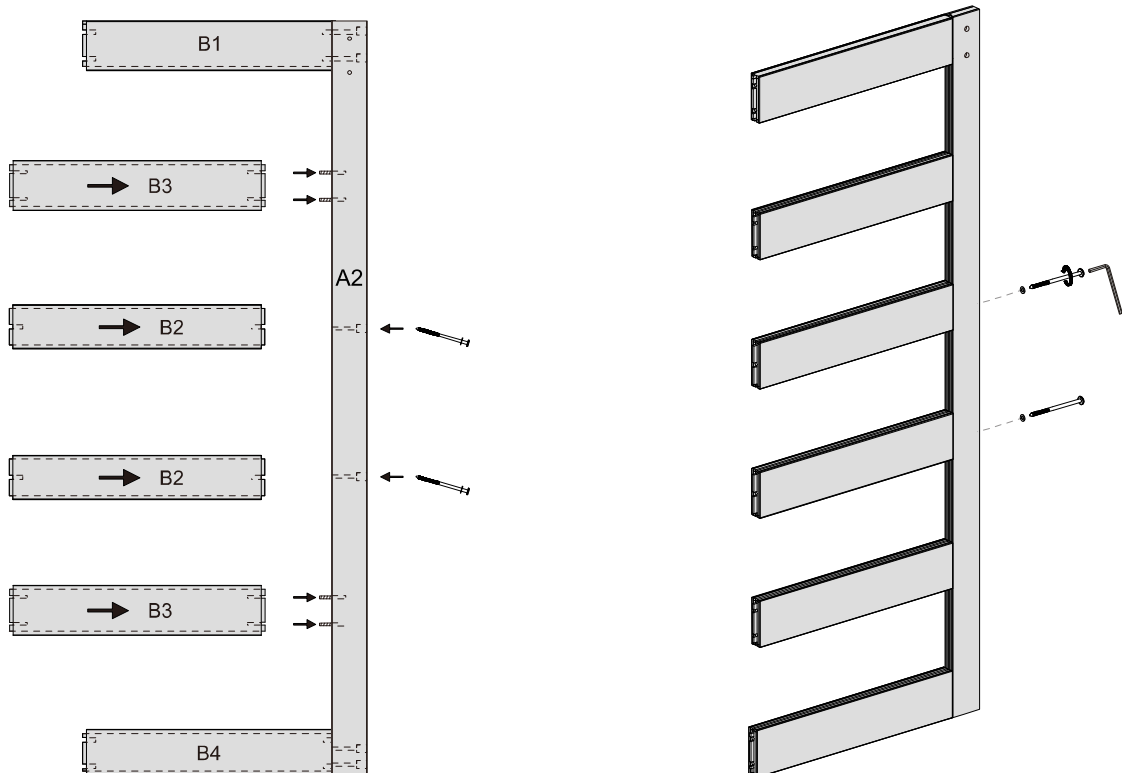

Step 3.

Gently slide five G tempered glass panels into Side Stile A2 groove. Then insert 2 wood plugs into each left side of Rail B3 and 1 woodplug into each left side of Rail B2.

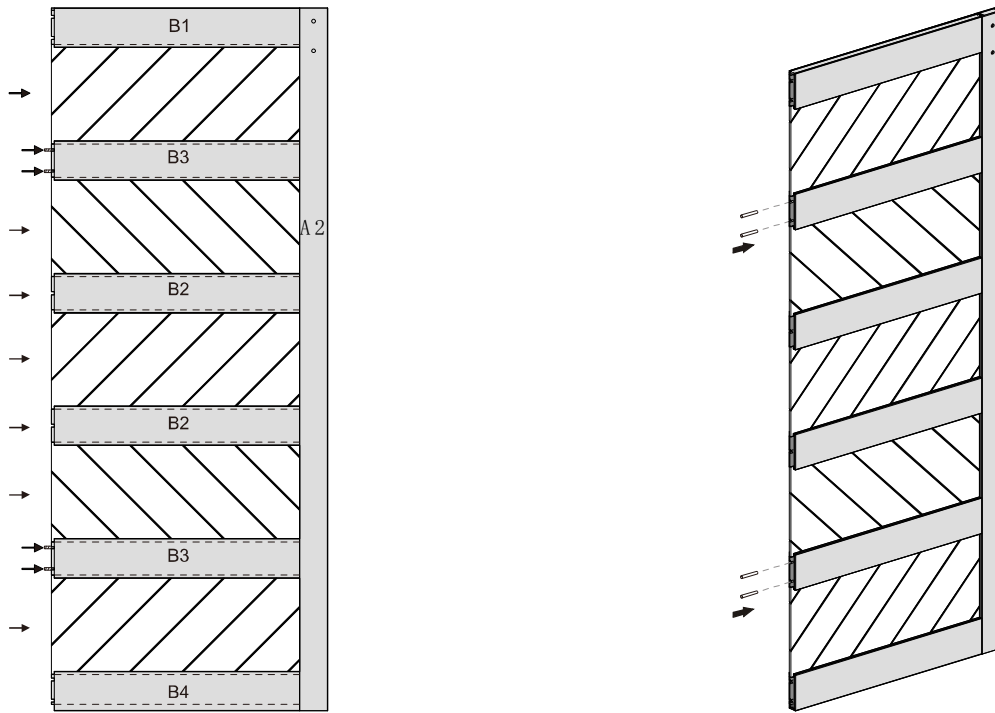

Step 4.

Align Side Stile A1 holes with wood plugs and make sure all the tempered glass align with stile's groove. Fasten Side Stile A1 with Rail B1, B2 and B4 using carriage bolts.

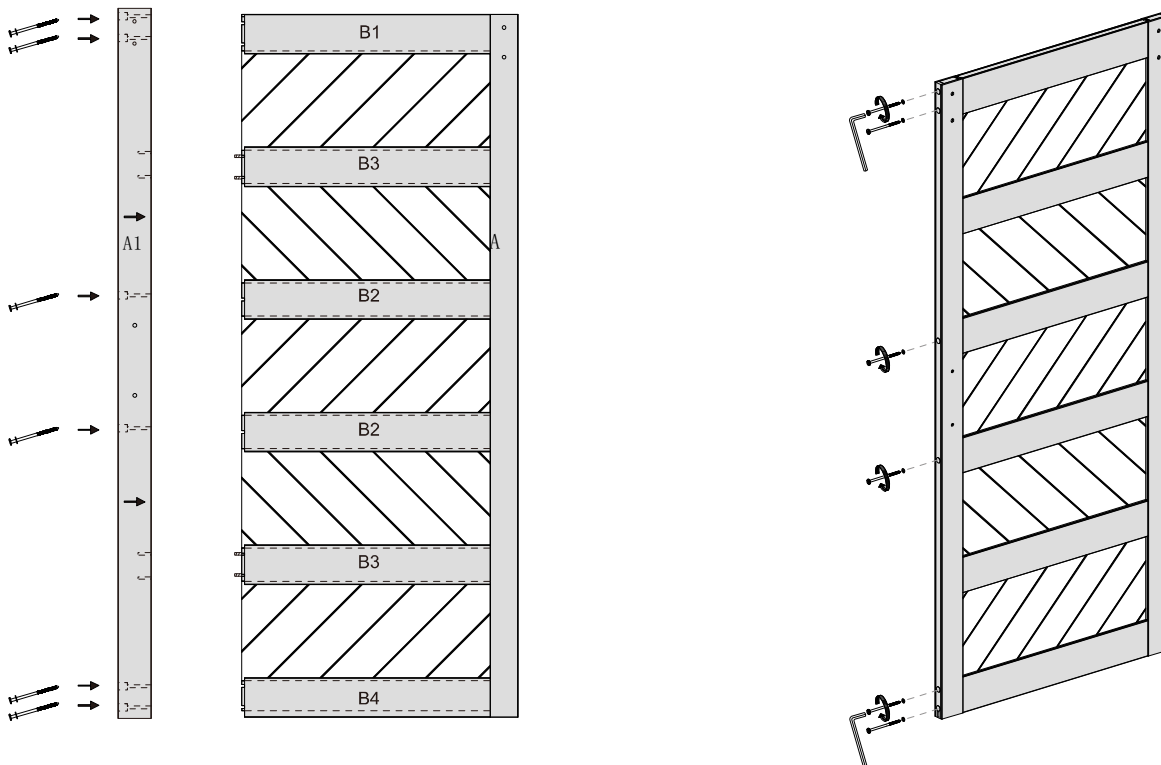

Step 5.

Make sure all bolts are tightened, place **E Plastic Caps** on top of the bolts and flush with Side Stile surface.

