

Instruction Manual

4-Light Flush Mount Lighting

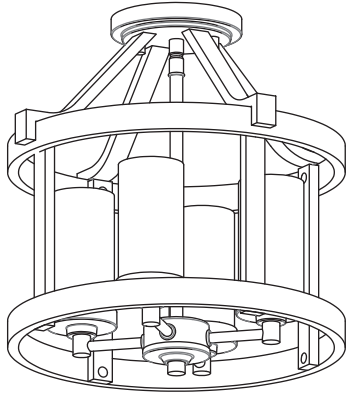

Overview

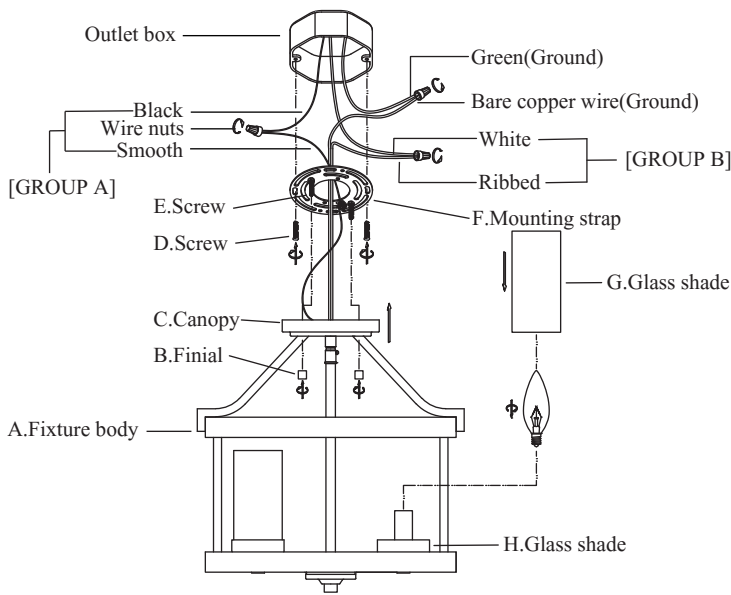

Assembly Instruction

1. Fix Mounting strap (F) to outlet box with Screw (D).
2. Connect the wires according to the picture above.
(Please refer to the wiring instruction for details)
3. Pass Canopy (C) through the Screw (E) and fix it with Finial (B).
4. Install light bulb (not included). Use four E12-base bulbs.
5. Place Glass shade (G) on the Lamp cup (H).

Wiring Instruction

1. Insert the green grounding screw into the hole with two raised dimples on the mounting bar. Wrap the ground wire from the fixture (if supplied) around the green grounding screw, then connect it to ground wire from the outlet box (if not fixed on the outlet box) using a wire connector(not supplied). If ground wire from the fixture is not supplied, wrap the ground wire (if not fixed on the outlet box) from the outlet box around the green grounding screw and tighten it.

NEVER CONNECT GROUND WIRE TO BLACK OR WHITE POWER SUPPLY WIRES.

2. Take note of the color of the wire(s) on your fixture. Identify which group your fixture wire(s) falls into and connect the wires according to the directions below:

[GROUP A]: Connect to Black House Wire	[GROUP B]: Connect to White House Wire
BLACK	WHITE
*PARALLEL WIRE (round & smooth)	*PARALLEL WIRE (square & ridged)
WHITE OR GREY WITH TRACER	WHITE OR GREY WITHOUT TRACER
BROWN, GOLD OR BLACK WITHOUT TRACER	BROWN, GOLD OR BLACK WITH TRACER

3. Take your fixture wire(s) from [Group A] and place evenly against the black wire from the outlet box. Do NOT twist wires together before using wire connectors.

4. Fit a wire connector over the wires and screw the connector clockwise until you feel firmness.

5. Try gently to pull the connector off the wires. If you can pull the connector off, carefully re-do steps 3 and 4 as above, and check again for a firm connection.

6. Connect the fixture wire from [Group B] to the white wire from the outlet box in the same manner. Make sure no bare wires can be seen outside wire connectors.

Product Specifications

Input voltage 120V
Rated power 40W MAX
Lamp socket E26

Product Packaging

Fixture body × 1
Mounting strap × 1
Screw × 2 & Wire nut × 3
Glass shade × 4
Lamp instruction × 1

Cleaning

To clean, wipe fixture with a soft cloth. Clean glass with a mild soap. Do not use abrasive materials such as scouring pads or powders, steel wool or abrasive paper.

Safety Information

Always switch off the electricity supply and allow to cool for 10 minutes before changing the light bulbs.