

Assembly Instructions

Caution : You must read this before you proceed.

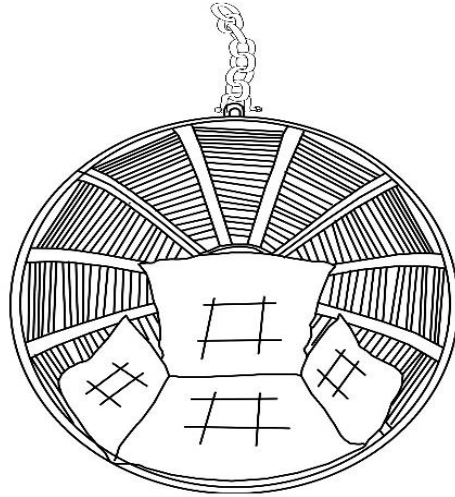



BASKET

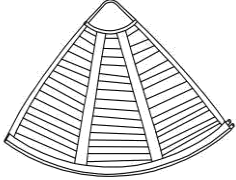
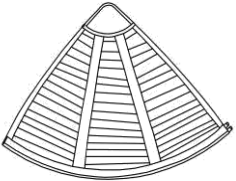
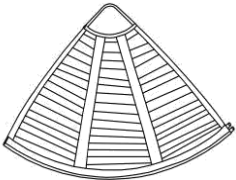
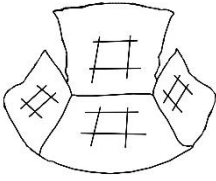

! WARNING:

Thank you for purchasing the Hanging Chair. Please read below before you proceed.

1. Not intended for use by children 12 years of age or younger.
2. This is a hanging chair, not a swing chair.
3. Do not swing on or in the chair. It could cause the product to tip over, resulting in possible injury.
4. This chair basket is not a toy.
5. No mounting hardware kit included.
6. Professional installation required.

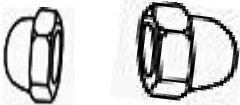
Parts List			
No.	Picture	Description	Qty
A		Top(With hanging chain)	1
B		Left back	1
C		Right Back	1
D		Seat Back	1
E		Cushion	1
Hardware			
①		Bolt(M8*50)	14
②		Nut((M8)	14
③		Spanner(M8)	2
④		Screw Protector Gap Set	14

Chair Basket intended for use with Iron Stand



Iron Stand (Separate Package)

1

Assembly preparation

Before Beginning Assembly:

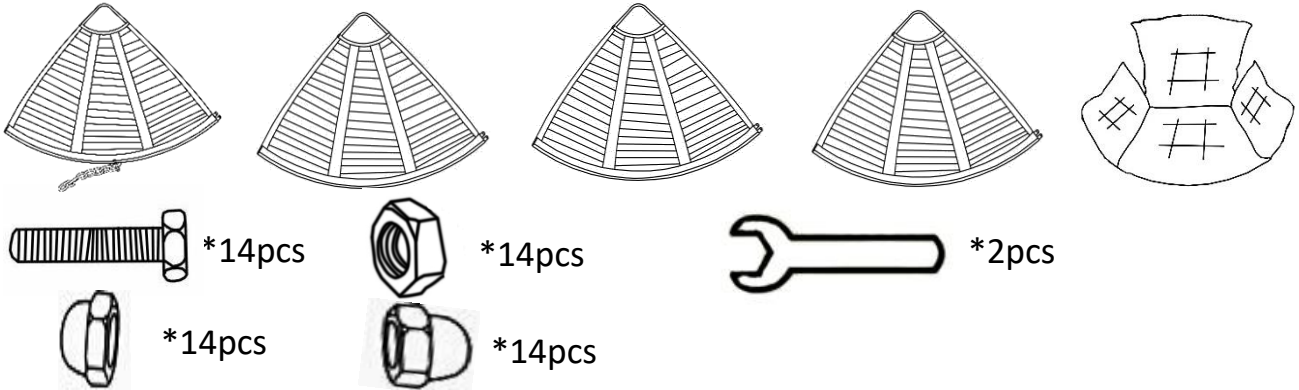

- Read the instructions before you start the assembly.
- May need assistance for assembly.
- Assemble on a clean and smooth surface.
- Save all package until finished.

Assembly Steps

Overview

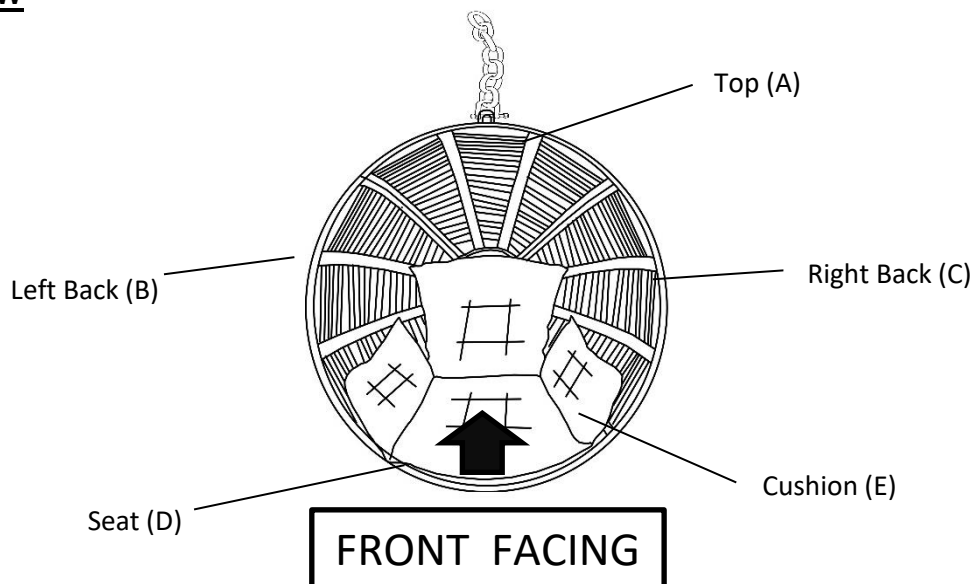

This Basket has multiple parts and may require up to 30 minutes to assemble. To give you an overview of the Basket parts, the above picture is to help you put the various parts into perspective. Please read through the instructions below to familiarise yourself with the parts and steps before assembly.

Step 1

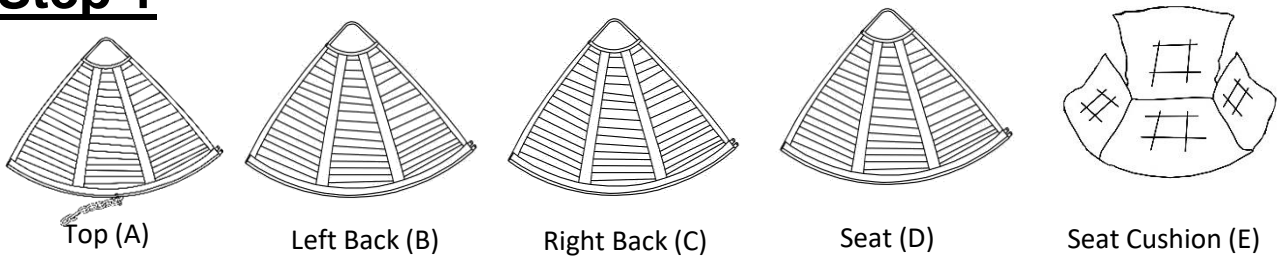

Unpack and place all parts on a clean, soft surface.

Step 2

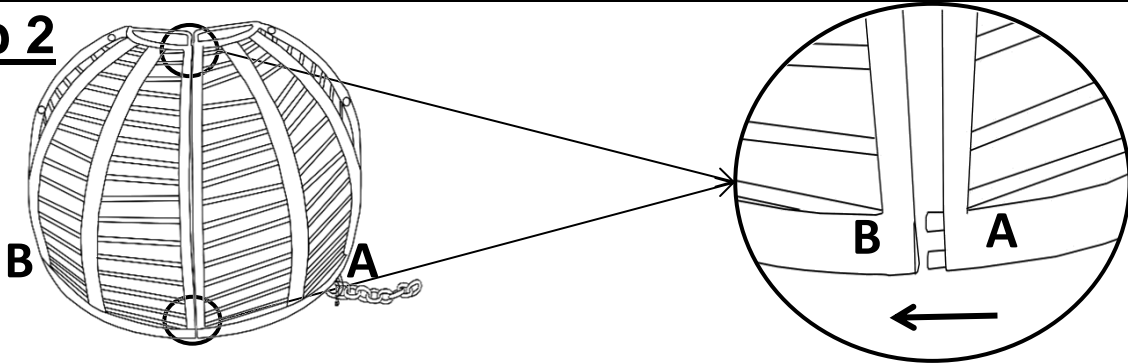

Attached Top(A) to Left Back(B) .

Step 3

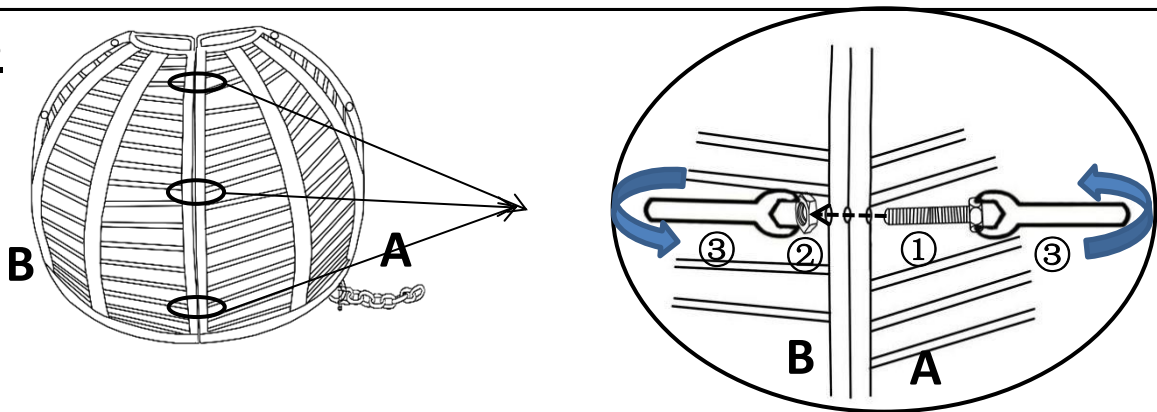

After finished above step 2, please connect Top(A) to Left Back(B), using the screw(①) and nut(②) with Spanner(③).
Loosely tighten.

Step 4

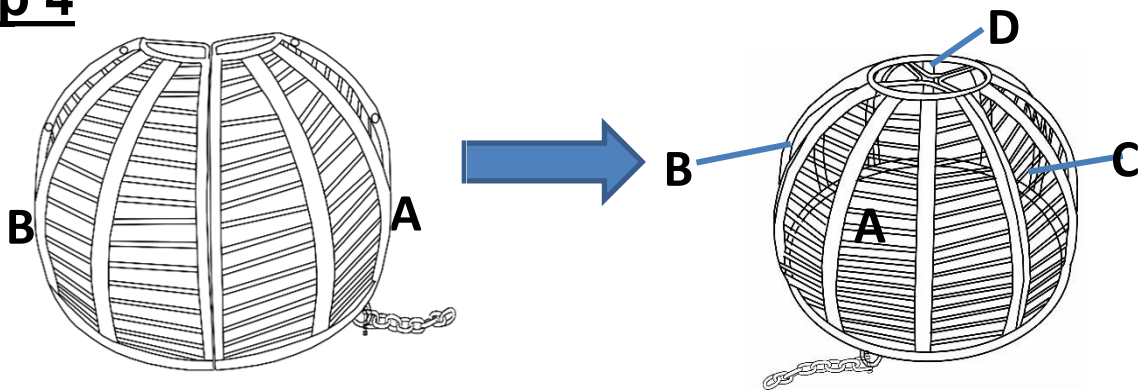

Repeat Steps 1 & 2 with Right Back(C) and Seat(D).
Tighten all screws and nuts.

Step 5

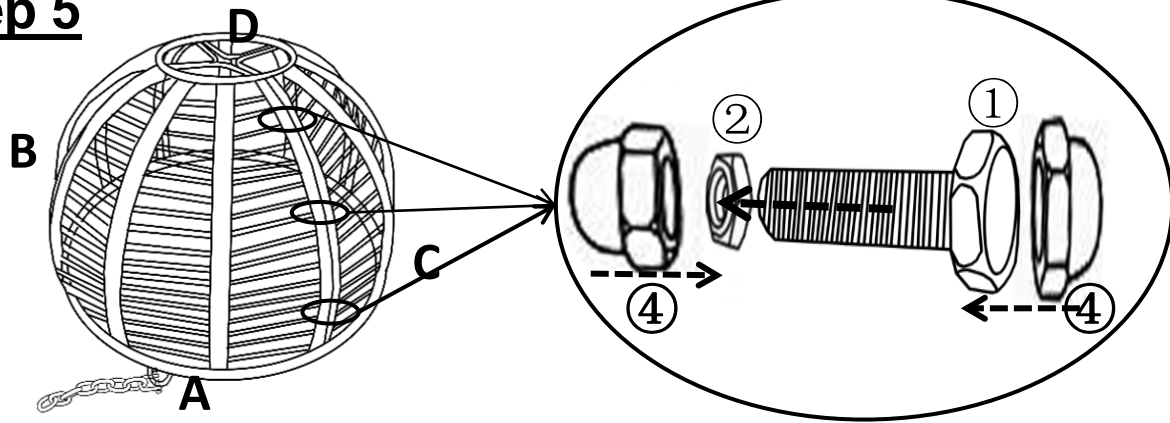

Attached Screw protector gap set(④) to all screw(②) and Nut(①) by hand.

Step 6

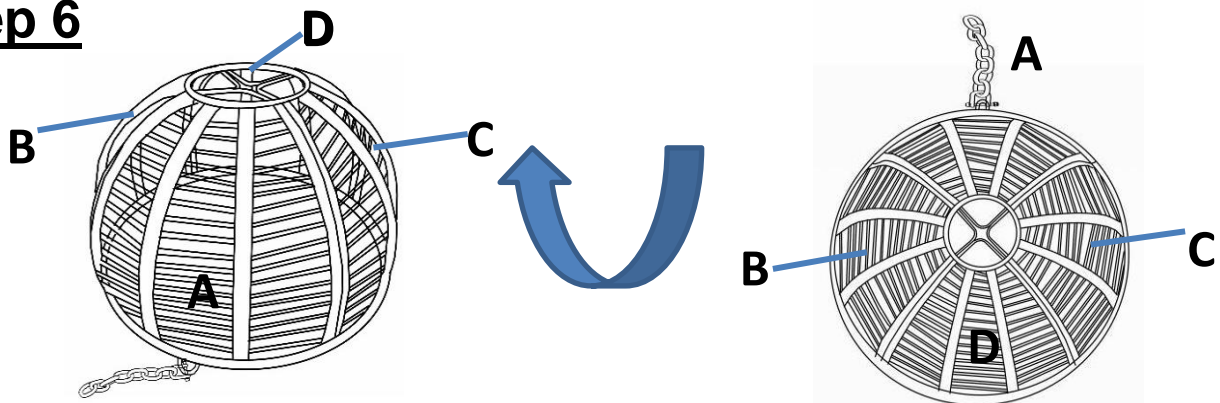

Turn the basket up as above show.

Step 7

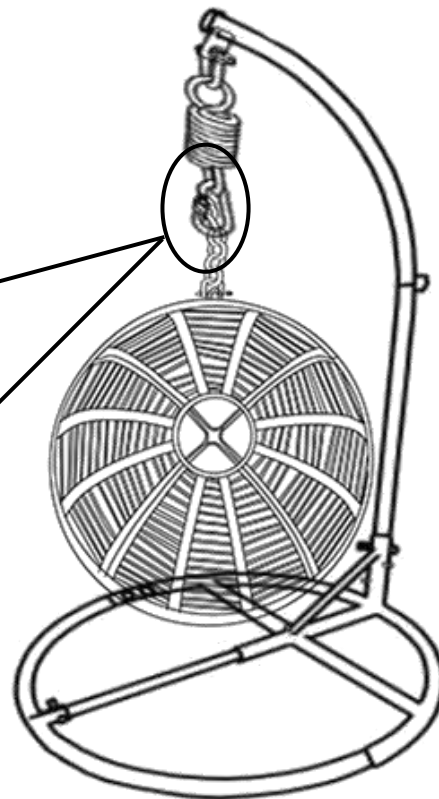
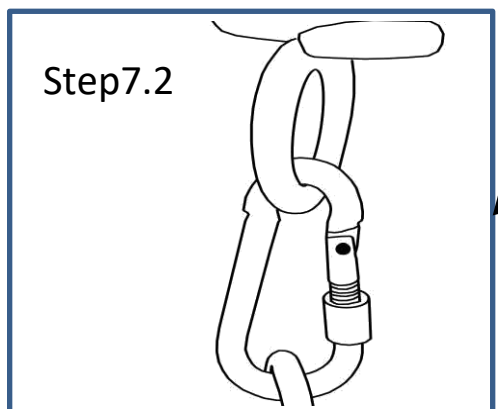
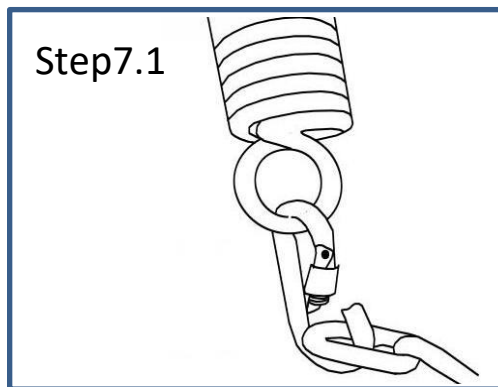

Step 7.1&7.2: Lift the Basket and hang the Iron Chain on the Spring of the Hanging Chair Base. And Screw the Safety lock tightly.

Step 8

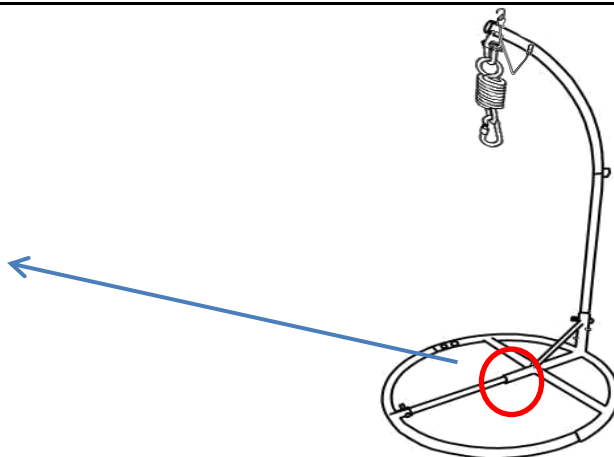
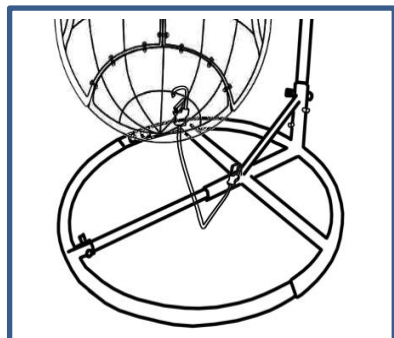

Lift the chair basket and hook up to Iron Chain(A) to the Iron Stand ,and fasten Safety strip as shown above.





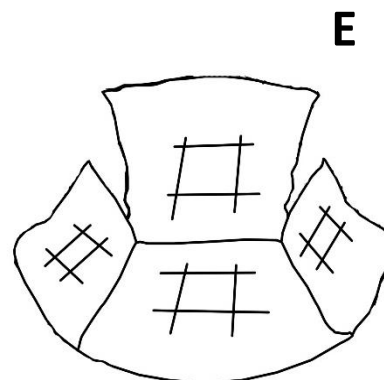
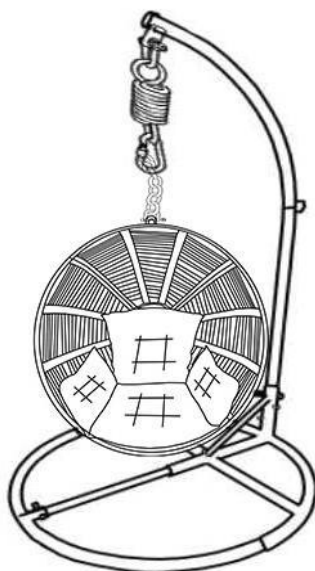



Note: This step should be completed with 2 adults

Step 9



Put Cushion(E), Adjust the Chain link to your preferred Seat Height.
Your Hanging Chair-Basket is ready for use.

Care & Maintenance

- ⊘  ● Do not put hot items directly on furniture surface.
- ⊘  ● Do not clean furniture with harsh cleansers or polish.
- ✓  ● To obtain the longest lifespan of your outdoor products, minimizing exposure to direct sunlight is recommended.
- ⊘  ● Children should not climb or jump on the furniture.
- ✓  ● To obtain the longest lifespan of your outdoor products, avoid extended and lengthy exposure to rain, snow, and direct sunshine. Whenever possible cover the product and /or place under patio or awnings.
- ⊘  ● Not for commercial use. For residential use only.
- ⊘  ● Stains may be removed with mild soap solution and damp cloth.
- ✓  ● Keep away from sources of ignition
- ✓  ● Dust and Pick-up spills: Use a Clean, non-colored, lint free cloth.