

READ AND SAVE THESE INSTRUCTIONS FOR FUTURE USE

ASSEMBLY INSTRUCTION

EN

- 1.This product must be assembled by an adult.
- 2.Do not over torque screws and bolts.
- 3.Do not install in flammable place in case of fire.
- 4.Use on a flat ground.

FR

- 1.Ce produit doit être assemblé par un adulte.
2. Ne serrez pas trop les vis et boulons.
3. N'installez pas le produit à l'endroit inflammable en cas d'incendie.
- 4.Veuillez l'utiliser sur un terrain plat.

ES

- 1.Esta jaula para mascota debe ser ensamblado por un adulto.
- 2.No apriete los tornillos y pernos demasiado.
- 3.Para evitar incendios, no instale la jaula para mascota en un lugar inflamable.
- 4.Utilice la jaula para mascota sobre un terreno plano.

















DE

- 1.Dieses Produkt sollte von einem Erwachsenen zusammengestellt werden.
- 2.Ziehen Sie die Schrauben und Bolzen nicht zu fest an.
- 3.Installieren Sie im Brandfall nicht an brennbaren Orten.
- 4.Bitte verwenden Sie es auf einem ebenen Boden.

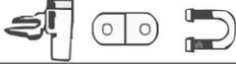
IT

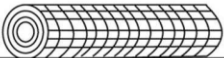
- 1.Questo prodotto va assemblato da un adulto.
- 2.Non stringere eccessivamente viti e bulloni.
- 3.Non installare in un luogo esposto a potenziali incendi.
- 4.Si prega di usare su una superficie piana.

3x2x1.95m LIST OF MATERIALS

PART NO.	DIMENSION	STYLE PIC	QUANTITY
①	1420mm		4
②	1925mm		5
③	970mm		4
④	1540mm		4
⑤	1680mm		2
⑥	630mm		1
A	312+1550mm	Door left	1
B	310+1550mm	Door right	1
C	497mm	Door buttom	1
D			6
E1			2
E2			2
G			2
I			12
J			2
K		 M8	8
L		 M10	4
M			1
O			1
P			1
Q			1
R			12
S			1
T			2

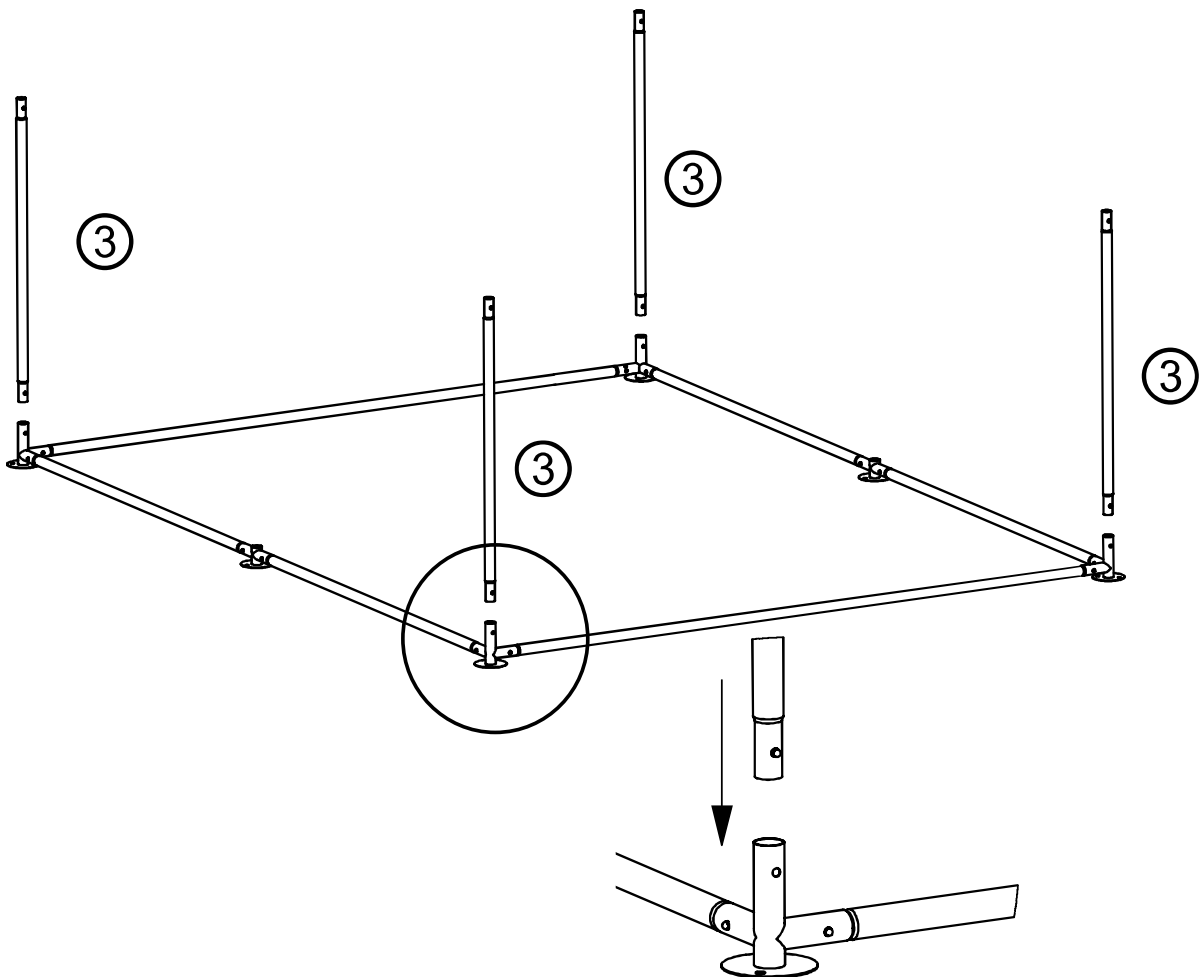
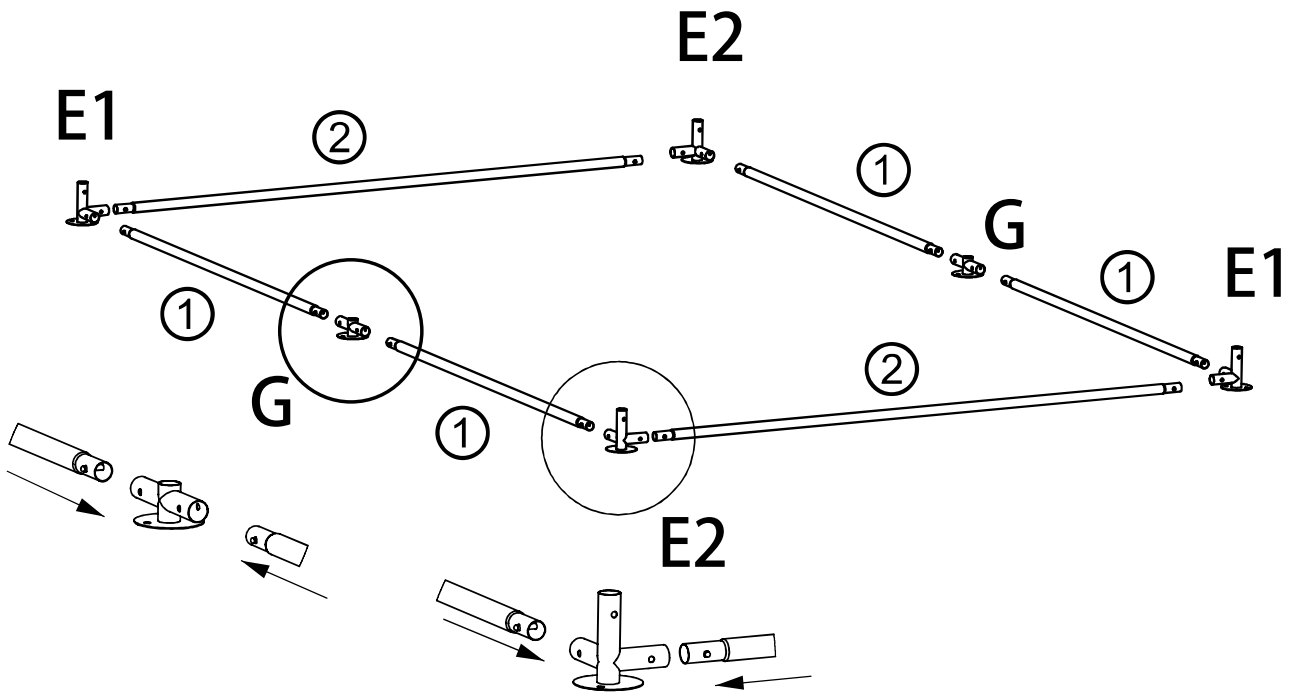

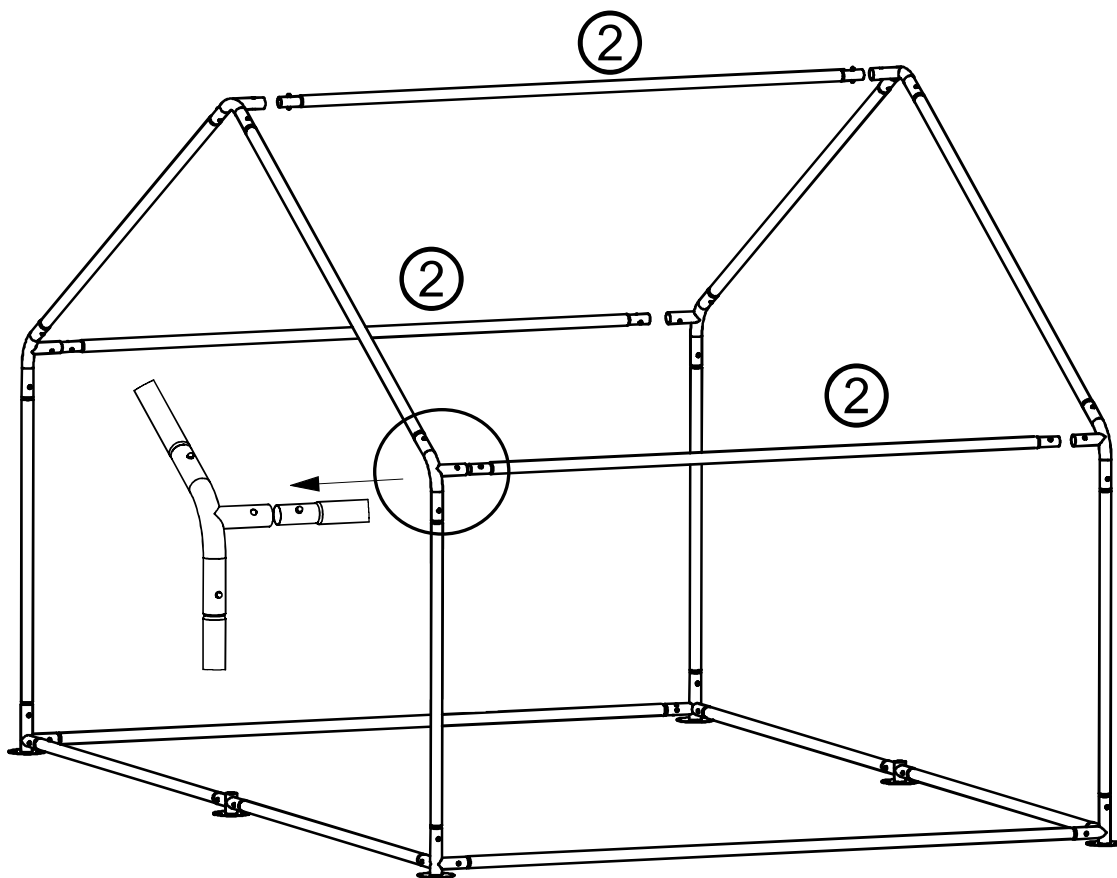
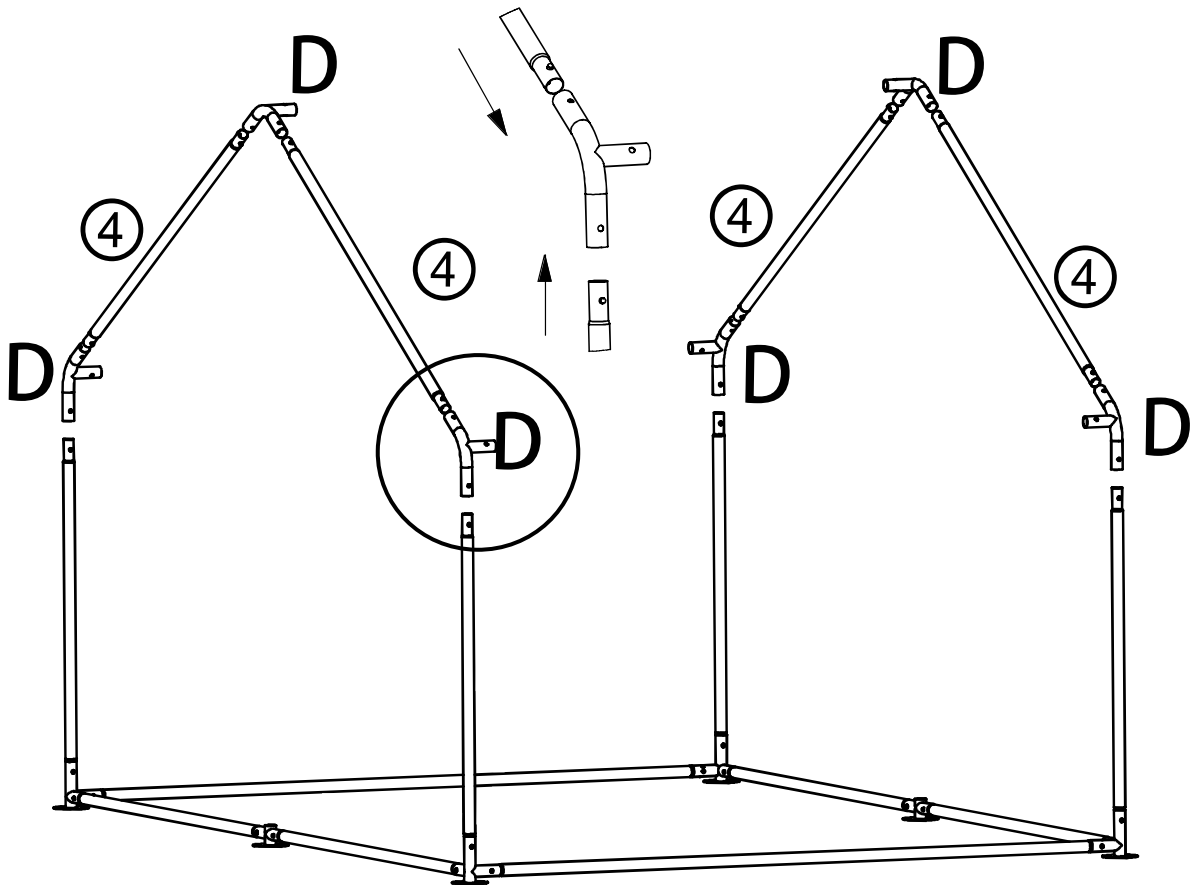

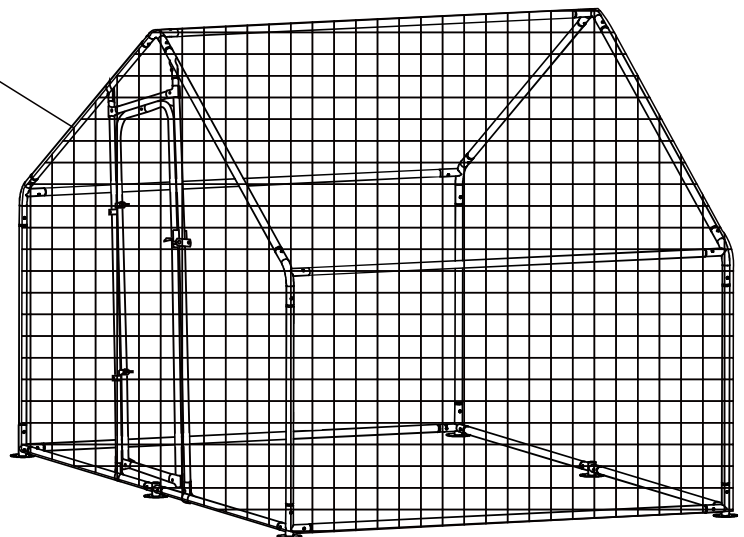
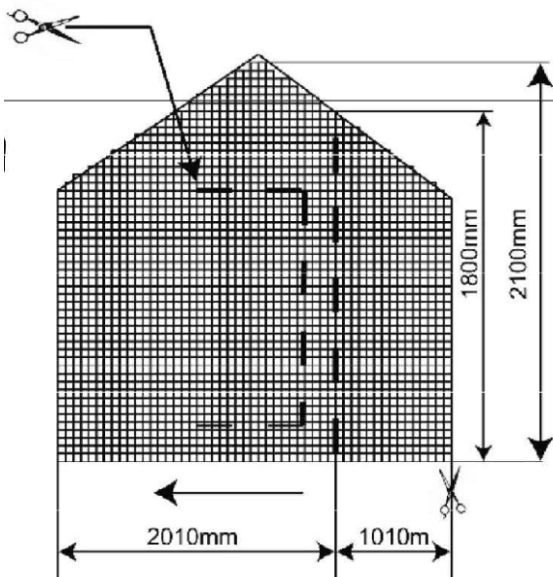
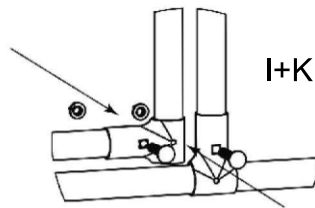
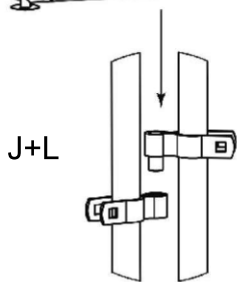
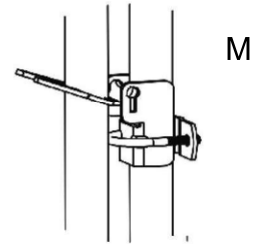
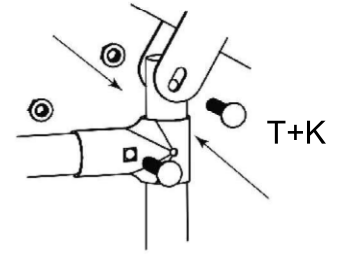
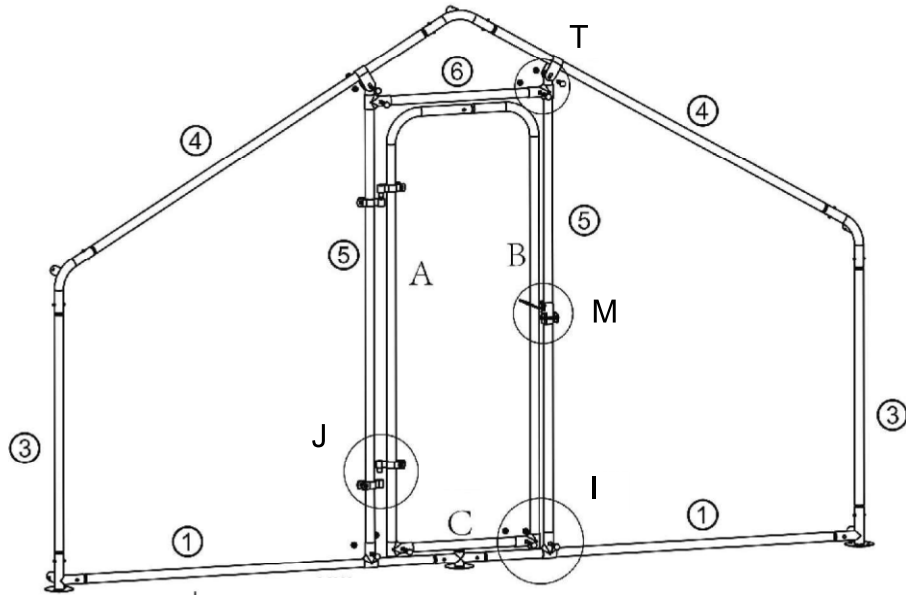

P

