

# Intelligent Toilet Manual

# Manual List

Thanks very much for using our products.

Please read and follow the instructions carefully before using. Save the instructions in proper place and do not loss it.

There would be a little difference from each item.

The shape of item in the manual is for reference only.

List of Functions & Configurations	01
Safety Guide	02
Safety Note	03
Attention in Using	07
Name of Parts	09
LED Display Description	10

## Instructions

Before Using	11
Remote Control	13
How To Use	14
Operating Note	16

## Routine Maintenance

Daily Cleaning	18
Cleaning After Cover	19
Installation	20
Not Use in Long Time	21
Battery Replacing	21

## In Case of Freezing

22

## Problem & Solution

23

## Specification

24

## Main Functions

Rear Cleaning		Rear cleaning by output water from nozzle
Bidet		Bidet cleaning for ladies
Moving Spray		More cleaning effective by moving nozzle
Massage		Massage by rhythmmed water pressure
Position Adjusting		The position of nozzle can be adjusted to forward and backward
Seat Heating		The cover can be kept in comfortable temp. by mico CPU control
Warm Wind Drying		Automatic drying after cleaning
Deodorization		The foul smell can be dispelled by the deodorization fillter
Soft Close		The soft hinge device help to keep quiet
Smart Sensor		The toilet will stand by while people seat on the inductive area
Smart Flushing		Auto flushing will be run after leaving the seat (kept seating for 10 sec) or drying or in one-key mode
Nozzle Self-cleaning		The nozzle will clean itself while it start to run or be end of working
Energy Saving		There is energy saving mode while the toilet is not in use
Pressure Adjusting		Increasing the water pressure would get better effect of cleaning
Instant Heating		The water can be heated to setting temp. instantly
Power off Flushing		The flushing still can be run while the power is off
Automatic Cover		The cover will open itself while people is in front of it in about 30cm (only for type-C product)
Temp. Protection		The cleaning function will be stopped while the water is cut in order to avoid scald
Foot Sensor Flushing		The flushing will run once time while the foot meeting the area of sensor at the bottom of right side (only for type-B product)
Foot Sensor		The cover will open itself while the foot meeting the area of sensor at the bottom of right side (only for type-C product)

## Functions For Each Type

Function Type	Rear	Bidet	Move	Spa	Position adjust	Warm seat	Warm wind	Deodorization	Soft close	Power flush	Power saving	Nozzle clean	Smart flush	Press adjust	Night light	Instant heating	Seat sensor	Auto cover	Foot sensor flush	Foot sensor	Foot flush
A	✓	✓	✓	✓	✓	✓	✓	✓	✓	✓	✓	✓	✓	✓	✓	✓	X	X	X	X	
B	✓	✓	✓	✓	✓	✓	✓	✓	✓	✓	✓	✓	✓	✓	✓	✓	✓	X	X		✓
C	✓	✓	✓	✓	✓	✓	✓	✓	✓	✓	✓	✓	✓	✓	✓	✓	✓	✓	✓	✓	X

Attn: The manual of panel as below is for full functions. The actual functions are base on the real product.

## Safety Notes

Please read and follow the instructions carefully before installation and using.

The instructions must be followed while using the product.

### WARNING -Avoid accident of electric shock

1. Do Not Use the product in Wet Environment.
2. Do not drop the remote Control into bath tub Or Sink Or any liquid.
3. Do Not put Water Onto product Or Electric plug.

### WARNING -Avoid accident of getting burnt, electric shock and fire



1. It Requires Someone to accompany While Using the product for people who can not adjust the temperature correctly like children, elder, disabled, paraplegia, etc..  
And please set the temp. to lowest level or shut the function down.
2. The product includes functions Showed in this Manual Only.  
Please do not use extra devices unless we recommend.
3. Do not replace the wire or electric plug yourself while it is broken or dropped into water. The correct way is to call the professional maintenance staff to handle it or send it to a maintenance center.
4. Please ensure the wire would not be burnt.
5. Please do not use the product if you take sleeping pills or are over drinking , or feel drowsiness.
6. Please do not put anything into the hole or water tube.
7. Please do not use the product outdoors.
8. Please do not allow children play the product as toy.
9. Please use the new fittings and hose we supply.  
The old fittings and hose can not be reused.

Please Keep The Manual in place



## Safety Notes

Please do read and follow the instructions carefully before using. They are about safety of person.

### Symbols and meanings

 <b>Warning</b>	Ignoring this tag may cause serious injury or death.
 <b>Caution</b>	Ignoring this tag may cause injury or property loss.

### Symbols and meanings

	Dismantling is forbidden.
	Must follow.

## Warning



No splash

**It is forbidden to drop any water and detergent on the product or the electric plug.**

- May cause fire or electric shock.
- May cause breakage or leaking.

The smart toilet is an electric product. Please avoid splash and use it in a wet environment. Maintain air circulation when the product is used in bathroom.

- May cause fire or electric shock.

### Set the electric socket as below

- May cause fire or electric shock if not follow the instructions.
- a. Please use a high-sensitivity and fast leakage switch for the circuit of the electric socket. Or to use insulated transformer (>1.5KVA, <3.0KVA).
- a. The electric socket should be installed 0.3m at least up to ground and away from the bath tub.

### Must install the ground wire

- May cause electric shock without ground wire.

Attn: The electric resistance should be 4Ω and the diameter of the copper wire should be 1.6mm or above.

### Using the product in bathroom

**Make sure the power plug has been waterproofed with silica gel.**

- May cause fire or electric shock without waterproofing.

## Warning



No wet

- 1) The user can't directly spray water on this toilet, can use a damp cloth to clean.
- 2) The plug and socket of this toilet can't directly touch with water, and it supports to be used in a humid environment such as a bathroom.



No dismantle

Dismantle, repair or remould the product are forbidden

- May cause fire or electric shock.

**Stop using the product while it has malfunction**

- Please pull out the plug and turn off the inlet valve.



Forbidden

#### Malfunction:

Leakage  
Dehiscence  
Abnormal sound & smell  
Fuming & abnormal heating  
Blocking

- Keep using the product while it has malfunction may cause fire or electric shock or leakage.



Forbidden

**Do not use a unsteady socket**

- May cause fire or electric shock.



Forbidden

**Do not use water sources other than city water**

- May cause dermatitis.



No wet hand

Do not touch the electric with wet hands.

- May cause electric shock.



Forbidden

**Do not damage the electric wire/connected toilet**

Do not pull, process, heat, forcefully bend the electric wire connected toilet.

Do not put heavy item onto the electric wire, connected toilet.

- Ignoring the breakage and keep using product would cause fire, electric shock or short circuit.



Forbidden

**Do not use the power socket with lots sockets**

- Do not remould the wire we supply. That would cause fire or electric shock.



Forbidden

**Do not use the AC except 110v**

- May cause fire.

## Warning



Must follow

**PREVENT GETTING BURNT**

- Please set the seat temp. to home temp. if seating in a long time.
- Please set the seat temp. to home temp. and set the drying temp. to the lowest level for special people.

Users people who can not adjust the temperature correctly like children, elder, disabled, paraplegia etc..

who take sleeping pills or over drinking or weary or drowsiness

## Warning



**Do not any fire thing get close to the product**

- May cause fire.



**Do not block the outlet of warm wind**

- May cause fire, electric shock or breakage.
- Pay attention to children or the elder is using the product.



**Do not tackle the product strongly  
Do not stand on the product or put heavy items on it**

- May cause breakage or injury.
- May cause leakage.

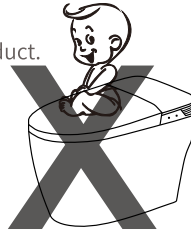

**The surface can be cleaned with neutral detergent only  
Do not use things as below**

- (Bath detergent, domiciliary detergent, petrol, thinner, cleaning powder, nylon brush, etc.)
- May cause breakage or injury.
- May cause leakage.



**Do not dismantle the inlet filter while the inlet valve is on**

- May cause leakage.



**Do not bend the tube**

- May cause leakage.

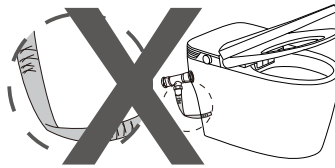

**Do not drop into the toilet bowl**

- May cause block & leakage.



**Turn off the power if the product is not in use for a long time**

- Pull out the plug for safety.
- May cause dermatitis by rancid water.



**Turn off the inlet valve while it is leaking**

Must follow



**Prevent the damage from being frozen**

- The inlet device and part of product would be damage by freezing and cause leakage.

Must follow



**Solidly install the inlet valve**

- May cause leakage if not to do.

**Please keep proper home temp.**



**Plug the electric plug well**

- May cause fire if the plug is unsteady or not plugged well.
- Pull out the electric plug if the product not in use in a long time



**Please pull out the electric plug while the toilet is blocked  
Reuse until the blockage is cleared**

- May cause leakage while running the cleaning function if not pull out the electric plug.



**Do not expose the product in direct sunlight**

- May cause damage of discoloration, aging and deformation.

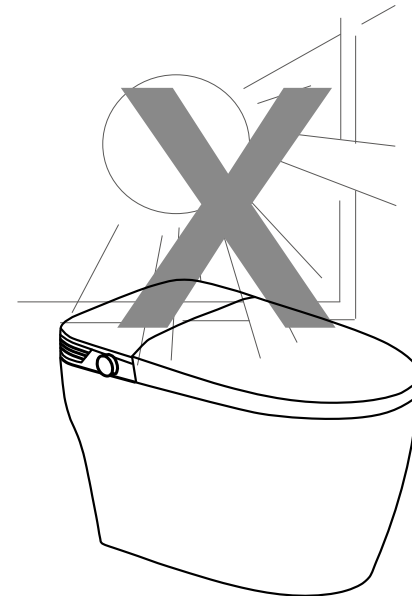

## Using Notes

### Wrong cleaning manners

Do not wipe the product with dry cloth or toilet paper.

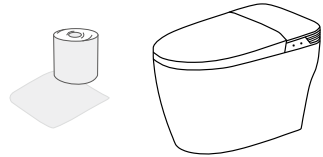

Flushing directly is forbidden

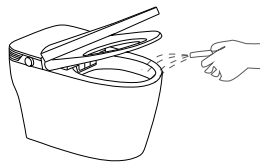

### Routine maintenance

Do not urinate on the nozzle or product.

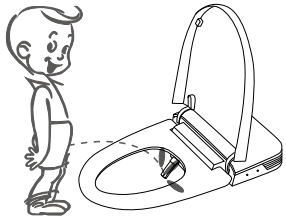

Pull out the electric plug when it is thundering.

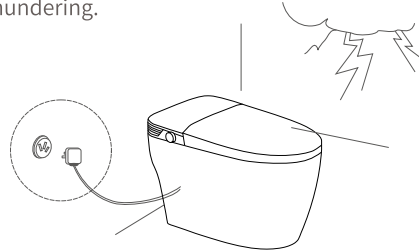

### Attention of operation

Do not cover the sensor area and remote control.

- May cause wrong actions.

Radio or similar products should stay away from the toilet.

- May cause much noise.

### Do not lean your back on the cover

- May cause breakage.

### Take the children cover away after children using the toilet fany.

- Not doing so may cause some functions can not run.

## Using Notes

Please prevent the freezing to avoid damage.

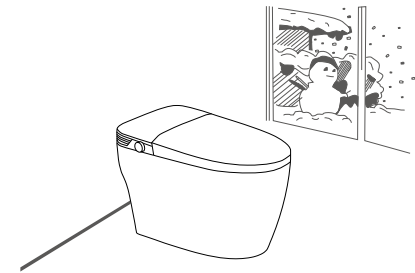

The heating apparatus should stay away from the product.

- May cause discoloration and error.

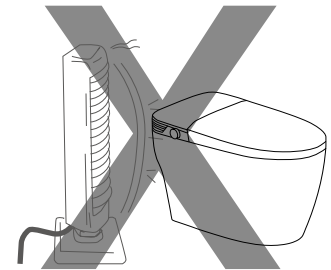

Please open the cover lid and cover seat gently.

- May cause breakage and error.

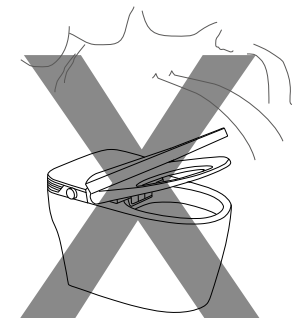

## Name of Parts

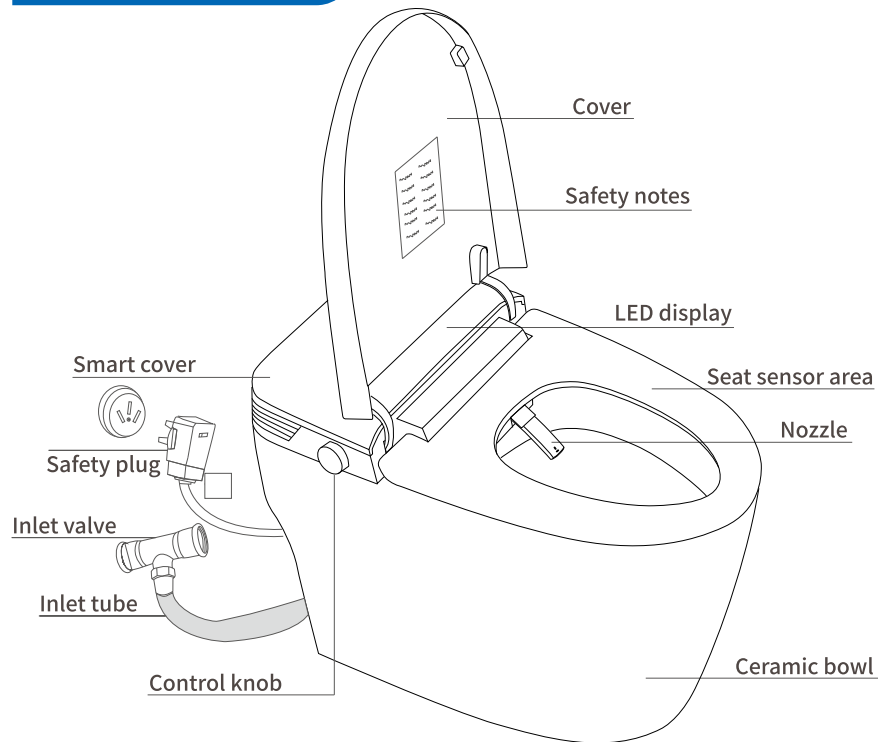

## LED Display

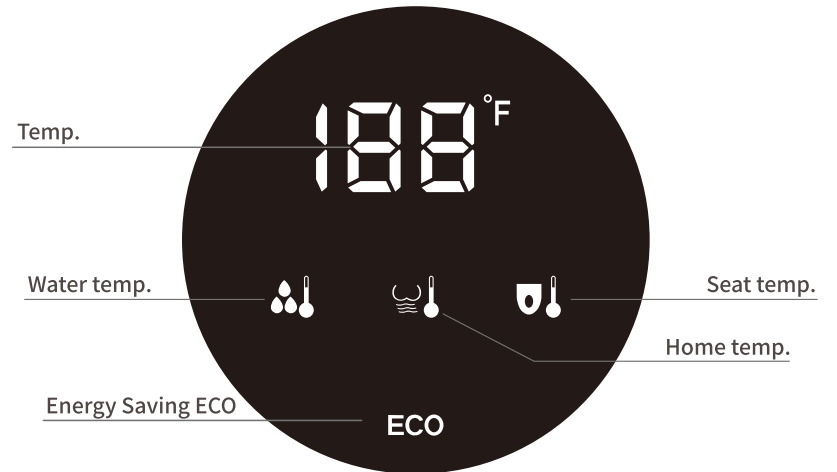

## Knob Manual

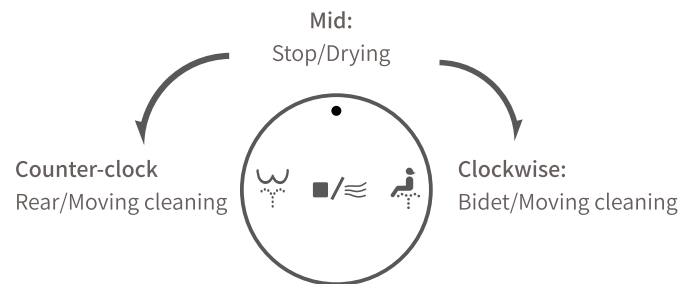

## Before Using

Please confirm things as below before using the product at first time.

### Plug well

1. Plug in the Listed local voltage.

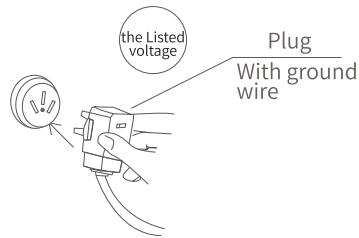

2. Please confirm the light of temp. is on or not.



2. Please the inlet valve is opened or not.

### Pair RC

Keep pressing the “bidet/female” key on the remote control until all indicating lights are flashing, then plug the the power cord of the smart toilet to the working socket, and wait until all lights are off to complete the pairing.

### Leakage Protected Plug

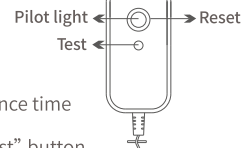

1. Please test once time each month
2. Press the “test” button
3. Confirm that the “pilot light” is off
4. Confirm that the product is out of work
5. Press the “reset” button to boot the the product if every steps as above are OK.

## Warning

- Please make sure the gound wire.
- Please contact electrical installation company if your socket is without ground wire.
- The original electric plug is for triple electrode type. (with ground wire)
- There will be changer of the electric shock while the product is out of work.
- Ensure the proper installation of water pipe, tube and valve, otherwise that would cause leakage and loss.



## Before Using

## Caution



1. The washing function is for instant heating type. The function would be out of work if the water inlet is error.
2. Ensure the inlet valve is open and the inlet tube is not bent after the product is booted.



## Warning

Only the listed voltage is a ccepted. Please follow the relevant regulations for wiring.



\* Will cause fire if ignore this warning \*

### Confirm each function

1. The nozzle, water pipe and tube.
2. The light of “saving mode” on LED display should be o ffwhile the seat sensor area is covered.
3. Check the rear & bidet washing, defecation assist, deodorization and drying function is well or not.
4. Check the damping is well or not.

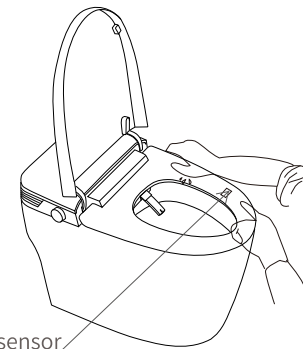

Seat sensor

Confirm that the seat sensor is on working and the light of “saving mode” or the pilot light is o ffbefore checking the function of washing, drying and deodorization.

## Remote Control

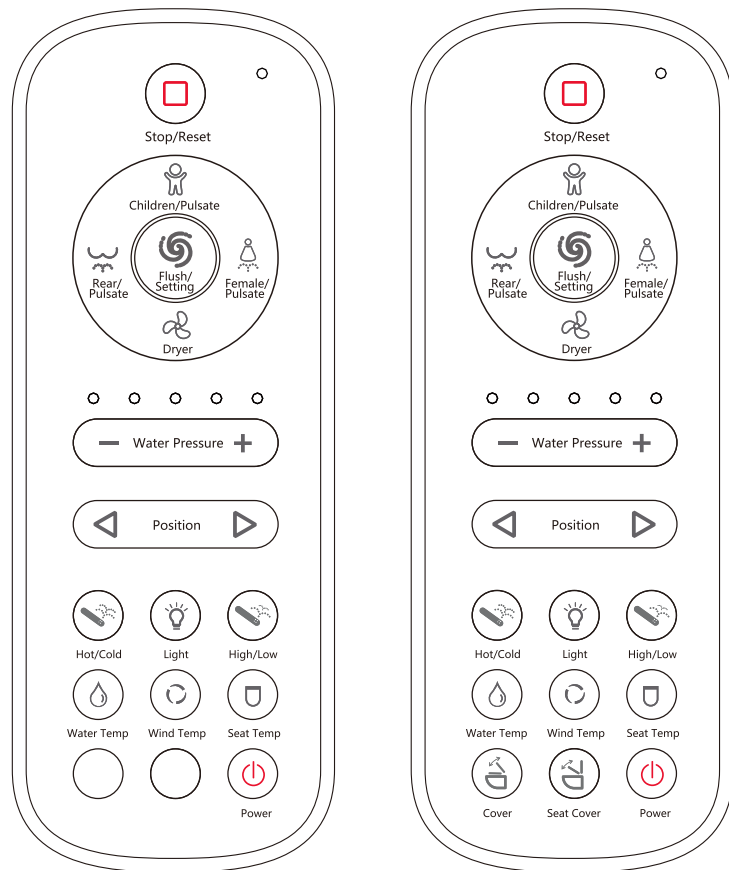













(please refer to the actual product)

### Pair the remote control to toilet





Step 1: Turn off the shut off the power supply to the toilet.

Step 2: Keep pressing the “bidet/female” key on the remote control until all indicating lights are flashing, then plug the the power cord of the smart toilet to the working socket, and wait until all lights are off to complete the pairing.

## Operation

- Power on/off**  
Keep pressing the power button  on the remote control or the power on the side knob for 3 seconds without seating to boot the product. The icon on the display and the side knob will be inlight. Press the power button again to shut down the product.
- Water temp. adjusting**  
Press button  can adjust the temp.on 4 levels: high, mid, low & home temp..
- Seat temp. adjusting**  
Press button  can adjust the temp. on 4 levels: high, mid, low & home temp..
- Drying temp. adjusting**  
Press button  can adjust the temp. in 4 cyclic levels: high, mid, low & home temp..
- Rear washing**  
Press button  to boot the function.
- Bidet washing**  
Press button  to boot the function.
- Massage**  
Press button  to adjust the water pressure and temp. automatically while the rear or bidet washing is working.  
Press the  button again to stop.
- Moving washing**  
Press “rear” or “bidet” button to boot the moving washing while the rear or bidet function is running. The nozzle will move forward and backward.  
Press same button to stop moving.
- Nozzle positon adjusting**  
Press “▶” “◀” button to adjust the position of nozzle for forward and backward while the rear or bidet function is running.
- Water pressure adjusting**  
Press “+” “-” button to adjust the water pressure to be stronger or weaker while the rear or bidet function is running.
- Drying**  
Press  button to run the drying function and it will stop itself in 3 mins.
- Stop**  
Press  button to stop the function which is running.
- Nozzle cleaning(by user)**  
Press the “rear” key and clean the nozzle gently after it comes out.  
For self-cleaning the nozzle will be back to original position in 15s. You also can press  button.
- Lighting**  
Press  button to open/close the night light .

## Manual

- ❑ Press  button to flush once. The flushing will boot itself after user getting off the seat. Boot rear/bidet/defecation while seating on cover, the flushing will boot itself after the operation is done.
- ❑ **Auto open/close Lid (only for type-C)**  
Press  button on remote control to set the automatic Lid on/off.  
While the function is running, the cover will open itself when people get close to toilet less than 35cm. And the cover will close itself without any operation or people leave the seat in 150s.
- ❑ **Remote control open cover**  
Press  button once to open cover lid and press again to open cover seat.  
That would not work if people is seating on the cover.
- ❑ **Remote control close cover**  
Keep press  button for 3s to close the cover seat and cover lid.  
That would not work if people is seating on the cover.
- ❑ **Auto open/close seat**  
When the cover lid is open only, it will close itself in 150s without flushing.  
When the cover lid and cover seat are open, they will close themselves in 150s and the flushing will be run once.
- ❑ **Foot sensor**  
The cover will open while the foot catch the sensor area at right side on bottom. Operating again to close cover. (only for type-C)  
and the flushing will be run once.  
Flushing once while the foot catch the sensor area. (only for type-B)  
Type-A is without foot sensor function.
- ❑ **Auto energy saving**  
The energy saving mode will be booted in 3min after people leaving the seat without any operation. The water & seat temp. will be set to low level until people seat on the cover again.

## Using Notes

### Water Temp.

#### Capacity

Instant heating device ensure the

#### Water temp. base on level setting

Normal: No heating  
Low : About 91°F  
Mid : About 97°F  
High : About 104°F

The effect of heating dependson the water temp.



### Seat Sensor

The washing functions would not run by operation in error

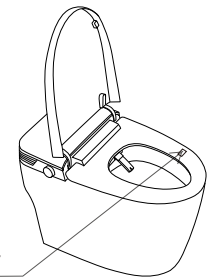

Seat Sensor

The seat sensor would not work if:

- ❌ No people the seat sensor area.

## Using Notes

### Energy Saving(ECO)

Would save energy as below

- Close the cover after using
- Do not set the high level for temp. every time
- Set the suitable temp. on seasons and air temperature
- Use the energy saving as much as possible
- The power if the product will not in use for a long time
- ※ Prevent the freezing

### Close Cover Softly

The soft-close device would avoid the noise of cover closing

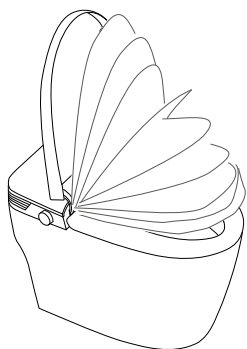

### Water flow out ?

That would be normal that some water flow of the nozzle before/after washing or while the water temp. setting is on.

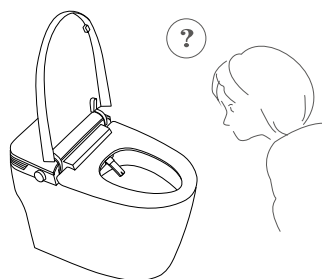

Please close the inlet valve and pull out the plug if the water keep flowing out besides the situations as above. And you need to contact the agency.

## Maintenance

### ⚠ Warning

Make sure to unplug pull out the electric plug and confirm the pilot light is off before maintenance.

### Maintenance of Smart Toilet

Please use soft cloth with clean water

- Please wipe the product often with wet soft cloth in case of the dirt is too hard to clean out. In addition, the wet soft cloth can avoid the static to adsorb dust and cause the product dirty.

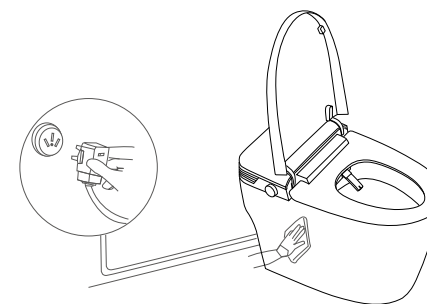

### Maintenance of Nozzle

- Please clean the nozzle with soft brush.
- ※ Turn the knob key until the nozzle is out after leaving the cover seat.
  - ※ Do not pull out and bend the nozzle by force.

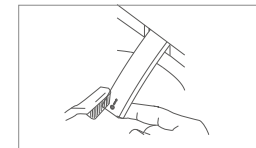

### ⚠ Warning

- ! Please clean the dust on the electric plug. Clean the plug with dry cloth after pull it out of socket.

Must follow ※ Poor insulation may cause fire.

## Cover Cleaning

(For professor only)

### How to dismantle the cover

1. Pull out the plug

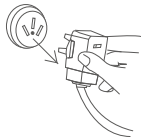

2. The inlet valve

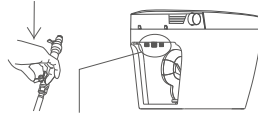

Pull out the three tubes on washing valve

3. Lift the cover up

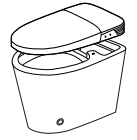

4. Put the cover on the cushion

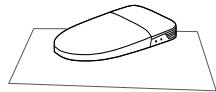

Be care of the nozzle and drying baffle

1. **Must pull out the plug**

✘ May cause electric shock

2. **Must clean up the water in toilet**

✘ May cause the fittings damage by water if not to do

3. **Do not extrud the wire and tube**

✘ May cause electric shock or leakage

4. **Handle with care while dismantling the cover to clean**

✘ May cause leakage and error

5. **Do not put the cover upside down and put on the ground without pulling out the plug**

✘ May cause damage of surface and error

6. **Please do mark and remember the position of installation for each water tube you are willing to dismantle.**

**Tighten the connecting parts to avoid leakage.**

Do not put the cover upside down.  
Do not put the cover on the ground.



## Installation

### INSTALLATION DRAWING PLAN & Names of Parts

As shown in Picture No.1, be the major component and construction points

Length Unit : mm

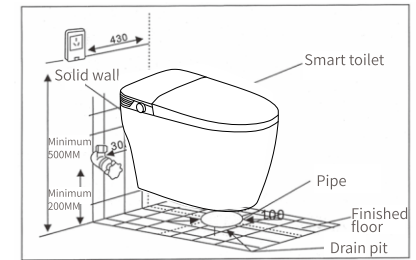

Fig1

### Before Installation

Required tools may include Adjustable Spanner, levelling instrument, cross screwdriver, glass cement, slotted screwdriver, measuring tape, knife, etc.

### Installation Procedure

1. Please mark the center line of the drain outlet on the ground, then according to the size of the toilet, install the water inlet angle valve on the suitable point of the wall.

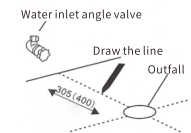

2. Lift the flip lid assembly from the toilet, up from the inside.  
Note: Do not pull the lid roughly when lifting the toilet flip lid

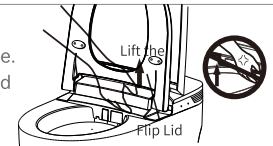

3. Please make sure the wall is aligned with the center line of the drain outlet (there are two pit distance options, 305mm and 400mm) Please mark the location of the center hole ( Use the right installed holes based on the real situation ) Install the sealing ring at the bottom of the toilet.

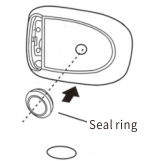

4. Install the flange and floor bolts at the sewage outlet according to the position shown in the right image. Attach the toilet to the flange, making sure the bolts line up with the holes in the toilet.

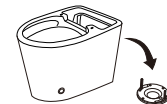

5. Use a wrench to lock the nut and other accessories to the retaining bolts.

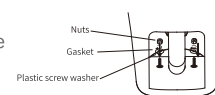

6. To install seat ring and toilet main body: the seat ring positioning hole shall be aligned with the ceramic body positioning column. Then in the seat ring's horizontal state, the hands pressure the back part of the seat ring, so that it can be completely installed.

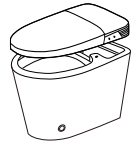

7. Please apply the transparent glue on the joint of the toilet bottom with the floor.

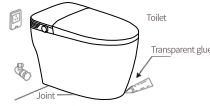

## Not in use long time

### Must clean up the water for situations as below

- The product will be not in use for a long time that would cause blockage by polluted water
- The water will be freezeed and leakage cause by falling temperature in uninhabited house

### Caution

Must the inlet valve before dismantling any inlet tube

Ensure correct installation of inlet tube

※ May cause leakage easily



## Replacing Battery

The pilot light will be getting light or off and the signal can not be transmitted when the battery is almost done.

※ The service life of battery we supply will be very shot cause it is mainly for checking conditions of running in the installation.

- Ensure the position of positive pole and negative pole is correct
- The new and old batteries can not be mixed together
- Please use alkaline battery

### Replacing battery of remote control

Open the back cover of remote control and replace two 1.5v AAA alkaline battery

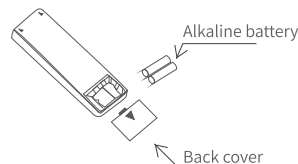

## Freezing Damage

The smart toilet will be damage and leakage cause by freezing water from toilet in winter.

Please follow the instructions as below to avoid it.

### General Measures

1. Keep power on

2. Set the water temp. and seat temp. to high level and close the cover

3. Turn on the heating in house
  - Please follow the ways as below to clean up the water from inlet tube if there is not heating.
    - a. Close the inlet valve
    - b. Run the rear washing until there is no water out after setting to normal level and put a hand on the seat sensor area.

### No water out cause freezing

Please use the hot cloth cover on the inlet valve or connecting parts until the water is unfrozen when the water is frozen.

### Caution

Do not put the hot water on the tube and do not blow hot air on it.

※ May cause damage of tube

### Caution

Must close the inlet valve before dismantling inlet tube.

Ensure correct installation of inlet tube.

※ May cause leakage easily



## Error Recognition

There are some simple can be fixed easily.

Please confirm matters below before sending the product to a maintenance center.

Error	Reason	Method
No water out	power of socket is off	check if power failure
	power of product is off	press "start" button to boot the toilet
	no plug in socket	plug in socket well
	leakage of electric	pull out the plug and send the product to maintenance center
	inlet valve is closed	open the inlet valve
	the fillter is dirty	clean the fillter
	inlet tube is blocked	clean up the tube
	out of seat sensor area	adjust the seating position
	the nozzle is blocked	clean the nozzle
	low water pressure	increase water pressure
	water pipe or tube is frozen	Please use the hot cloth cover on the inlet valve or connecting parts until the water is unfrozen
Water not warm	not set the proper water temp. yet	presse water temp. button and set a proper level
	temp. of inlet water is too low	run washing for a while and check after a period of time
Cover not warm	not set the proper seat temp. yet	presse seat temp. button and set a proper level
Smell not well	blocked by dust	clean the part of deodorization

Please contact fora service if the faults still can not be fixed.

## Specifications

(For AC 110V)

Part		Spec.	
Rated voltage		AC110V 50/60Hz	
Power		1150W (Inlet Temp.59°F± 2°F,0.2Mpa)	
Washing functions	Water flow	Rear	200-650 mL/min
		Bidet	200-650 mL/min
		Defaecate	200-700 mL/min
	Outlet temp.		home temp. / 91°F/97°F/104°F (4 levles)
	Pressure		3 levles
	Time required		5 seconds (base on inlet water temp.)
	Heating power		1400W (max)
	Safety device		flow sensor, temp. sensor, temp. control, relay
	Backflow prevention		retaining valve
	Drying	Wind temp.	
Air rate		≥0.2m³/min	
Heating power		250W	
Safety device		sensitive switch, temp. fuse	
Seat heating	Seat temp.		home temp. / 93°F/98°F/104°F (4 levles)
	Heating power		47W
	Safety device		sensitive switch, temp. fuse
Deodorize	Type	nano precious metal oxide catalyst technology	
Moving washing		1.5cm each for forward and backward	
Massage		strong and weak spaced vortex bubbles	
Nozzle position		adjustable for forward and backward	
Inlet water temp.		home temp.~ 104°F	
Inlet pressure		0.7-7.5khf/cm² ( 0.07-0.75Mpa )	
Carton size		768mmX505mmX565mm	
G.W		44.5kg	