

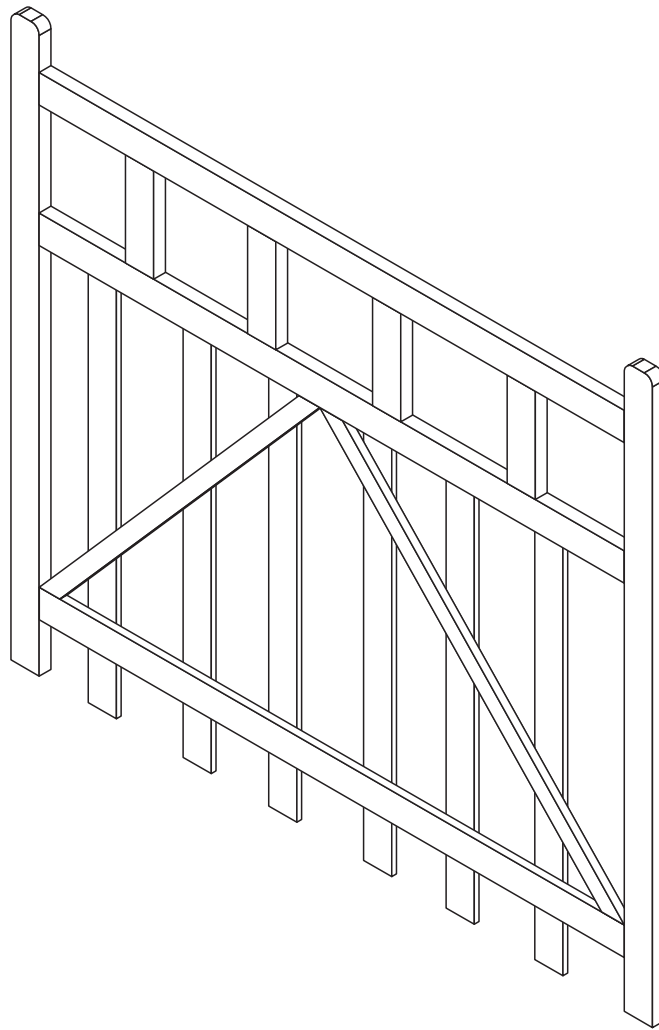

# ASSEMBLY INSTURCTION

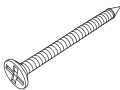

|   |   |  |   |  |  |
|---|---|--|---|--|--|
| <p><b>A</b><br/>M4*100</p>  <p>6 pcs</p> | <p><b>B</b><br/>M3.5*20</p>  <p>57 pcs</p> | <p><b>C</b></p>  <p>1 pcs</p> | <p><b>D</b></p>  <p>3 pcs</p>  | <p><b>1</b></p>  <p>2 pcs</p>  | <p><b>2</b></p>  <p>1 pcs</p> |
| <p><b>3</b></p>  <p>1 pcs</p>             | <p><b>4</b></p>  <p>2 pcs</p>              | <p><b>5</b></p>  <p>2 pcs</p> | <p><b>6</b></p>  <p>2 pcs</p> | <p><b>7</b></p>  <p>2 pcs</p> |  |

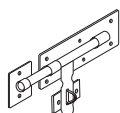
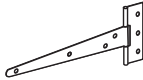
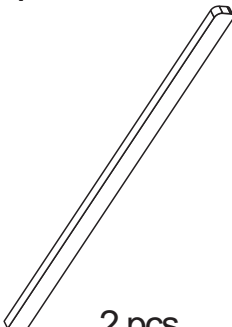
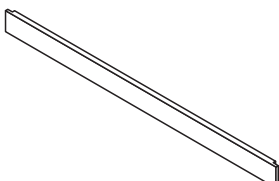
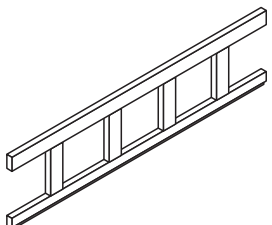
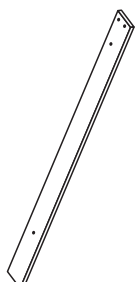
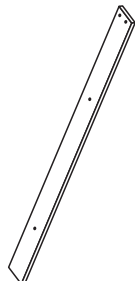
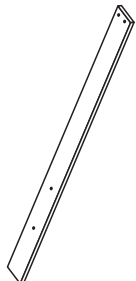
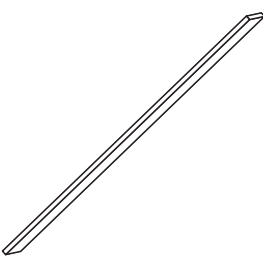