

ASSEMBLY INSTRUCTIONS

DECK BOX

SKU: T-PSB24-0641A

Patiowell,
Store
Your
Patio Well

www.patiowell.com



 Patiowell

Deck Box
Installation Tutorial

[https://www.patiowell.com/
pages/video-T-PSB24-0641A](https://www.patiowell.com/pages/video-T-PSB24-0641A)

 saleservice@patiowell.com





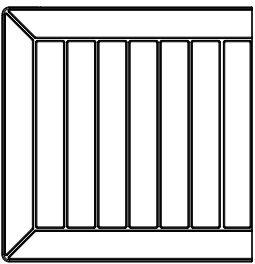
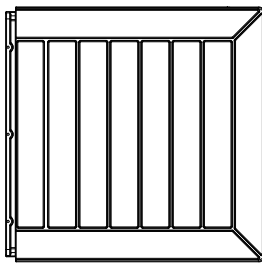
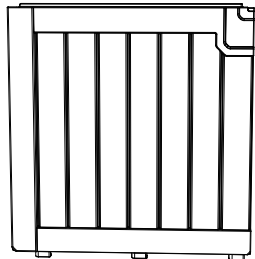
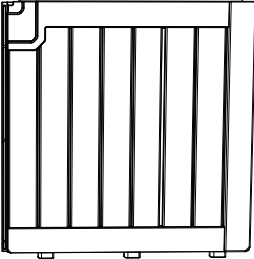
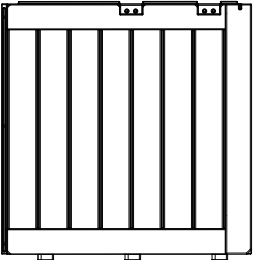
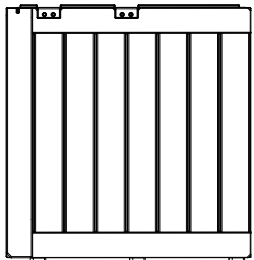
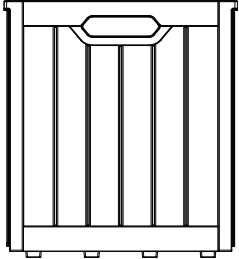
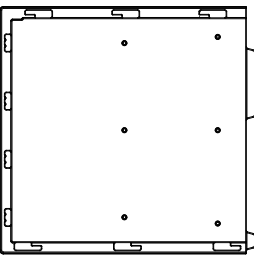
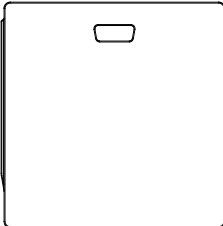
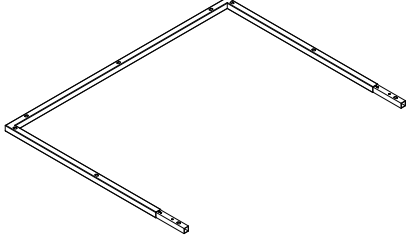





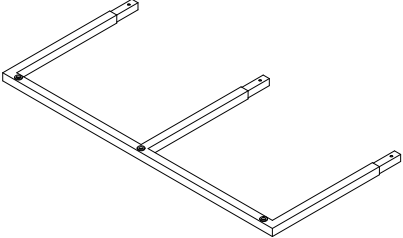
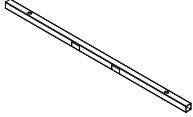

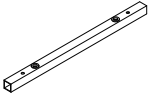
Parts

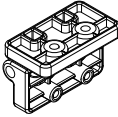
Check and make sure you get the components on the list, contact us for any missing.

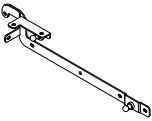
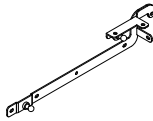
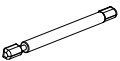
E1		X1	E2		X1
B2		X1	B1		X1
C1		X1	C2		X1
D		X2	A		X2
F		X1	E3		X2

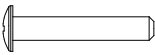
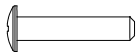
Parts

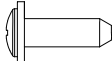
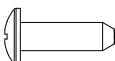
Check and make sure you get the components on the list, contact us for any missing.

A1		X2	E4		X2
			E5		X2
A2		X3	B3		X2
H		X4	C3		X4
D1		X1	D2		X1
D3		X2	G		X1
S1	 M5*28	X18	S2	 M5*25	X4
S3	 M5*16	X20	S4	 M6*20	X12
S5	 M6*20	X17	S6	 M4*12	X4
S7	 M4.2*13	X6			

Assembly steps

Step 1

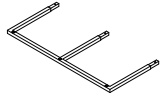

A1 (X2)



A2 (X3)



S7 (X6)

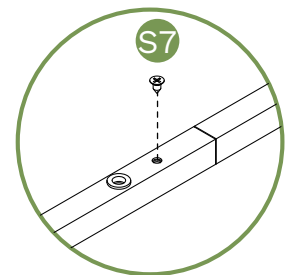
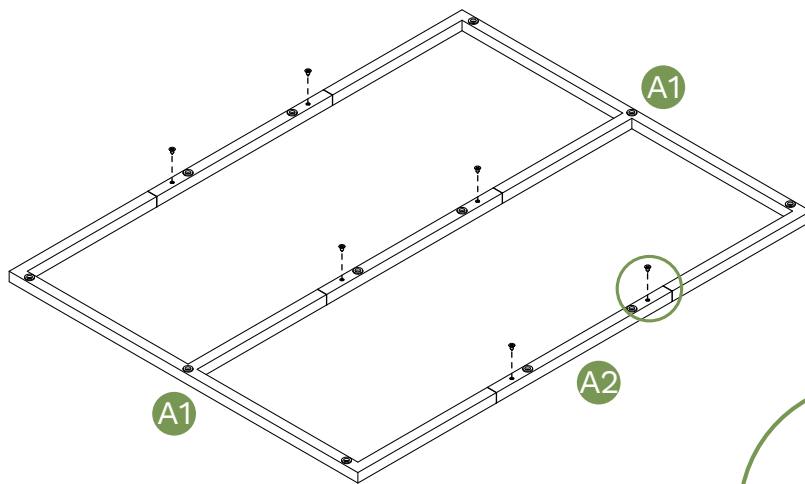
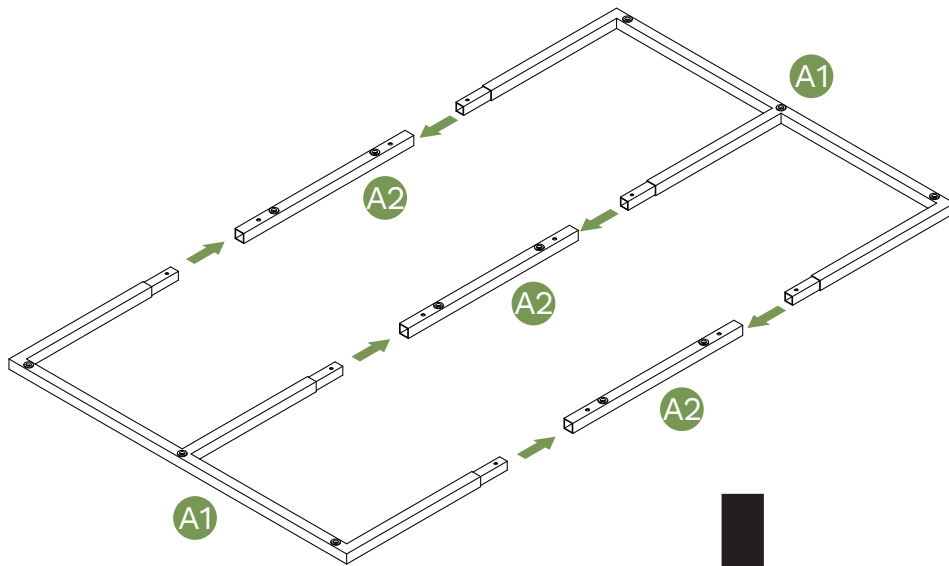

Assembly steps

Step 2

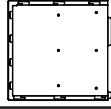

A (X2)

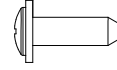

S4 (X12)

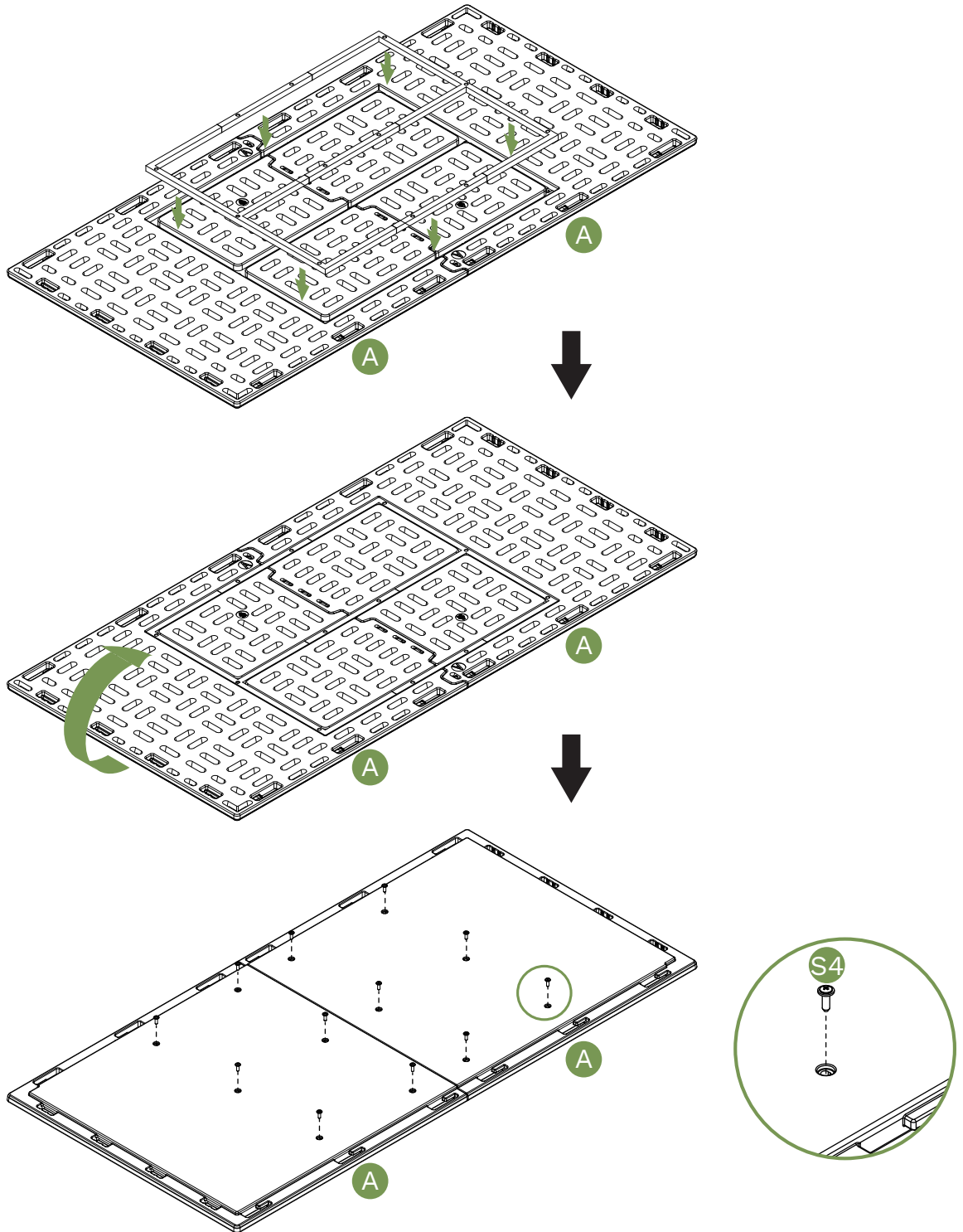

Assembly steps

Step 3



C1 (X1)

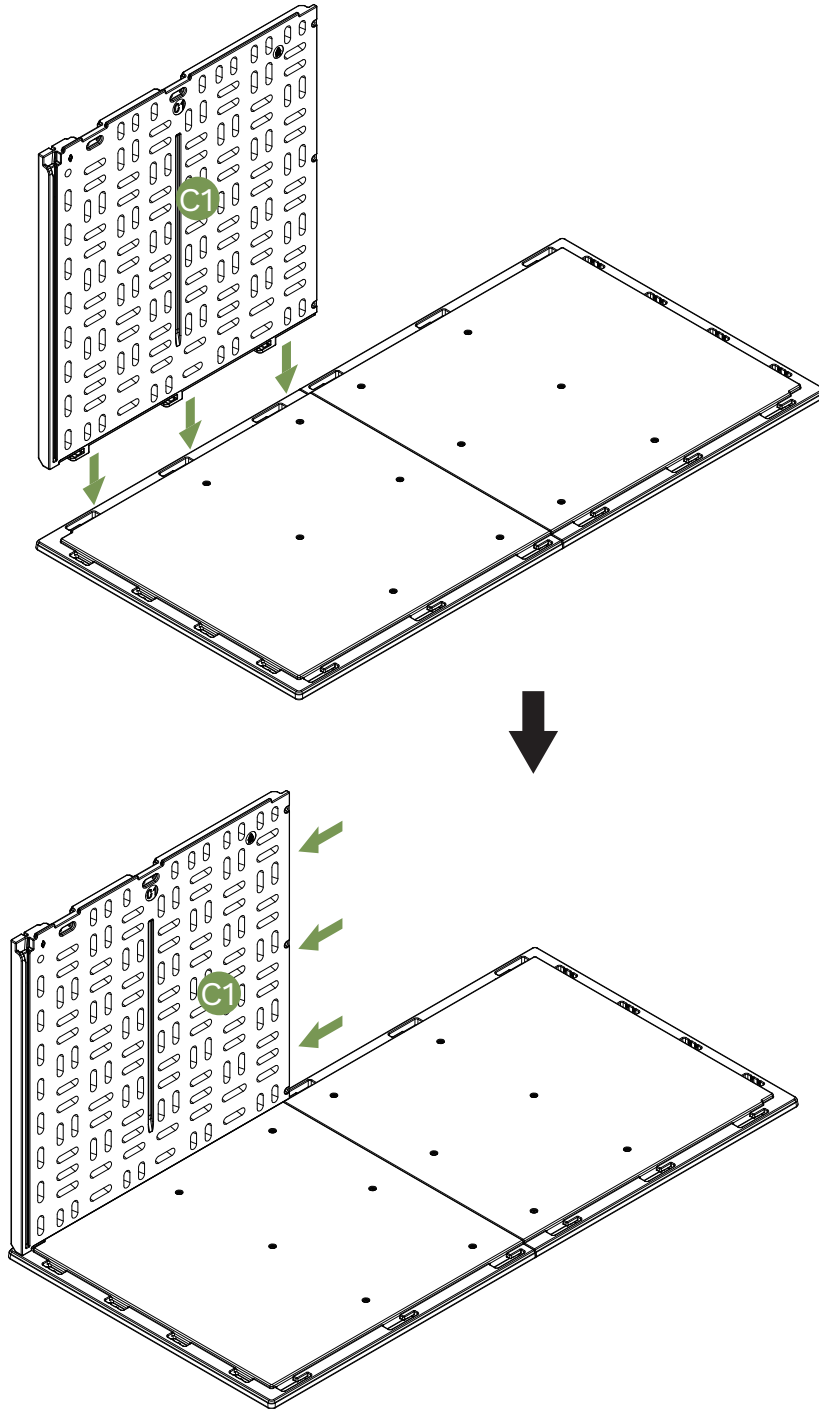

Assembly steps

Step 4

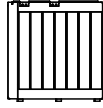

C2 (X1)

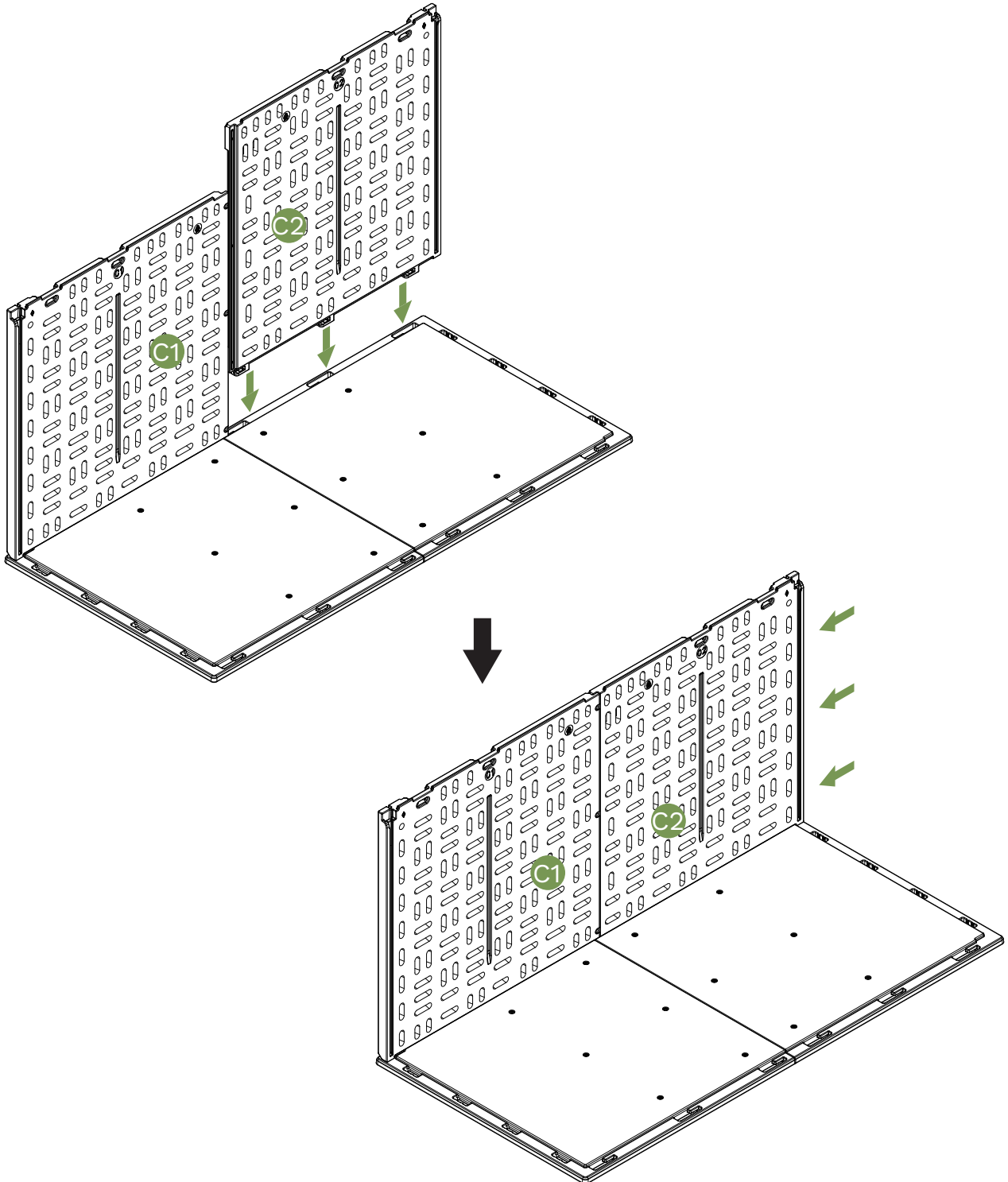

Assembly steps

Step 5

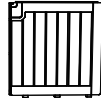

B1 (X1)

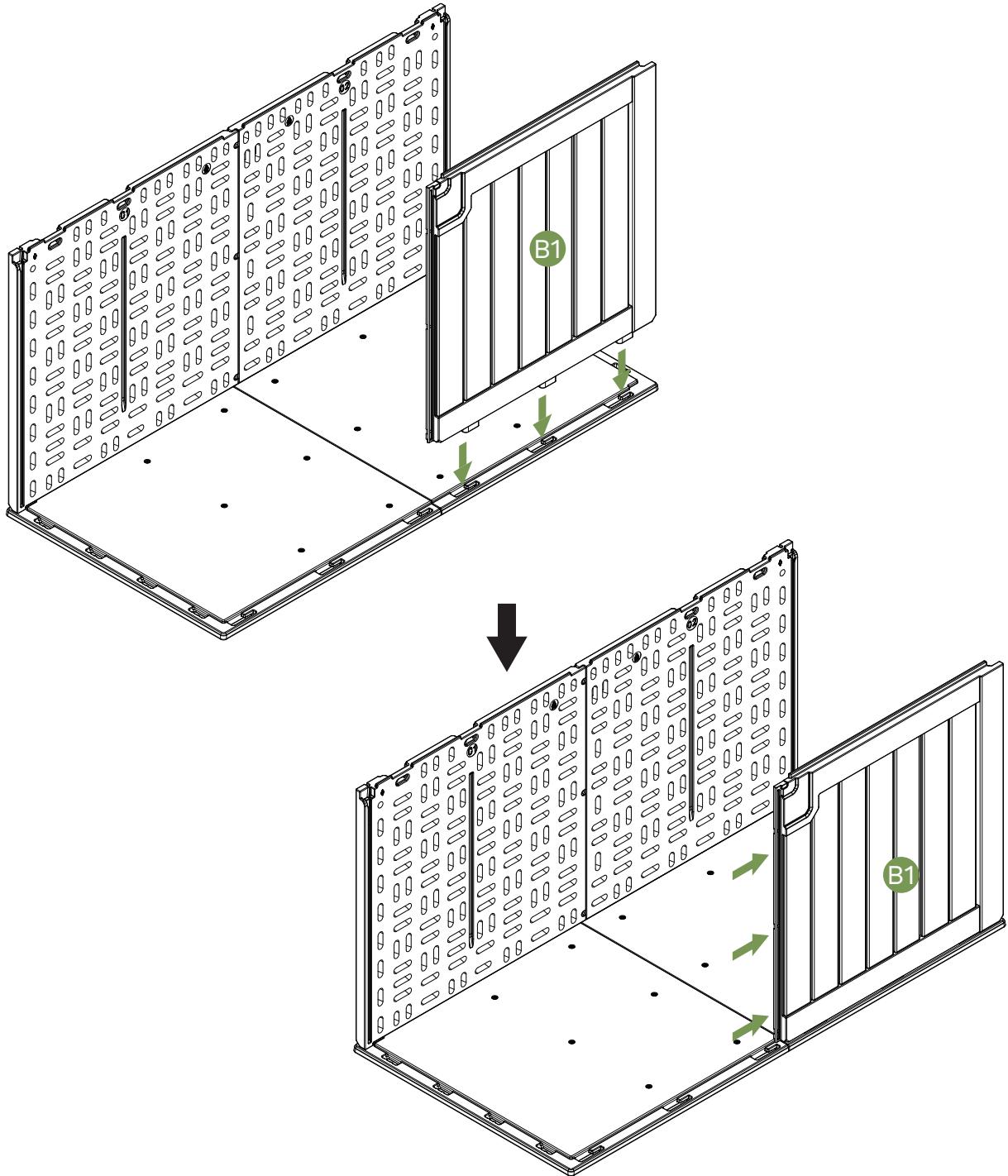

Assembly steps

Step 6

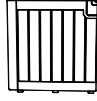

B2 (X1)

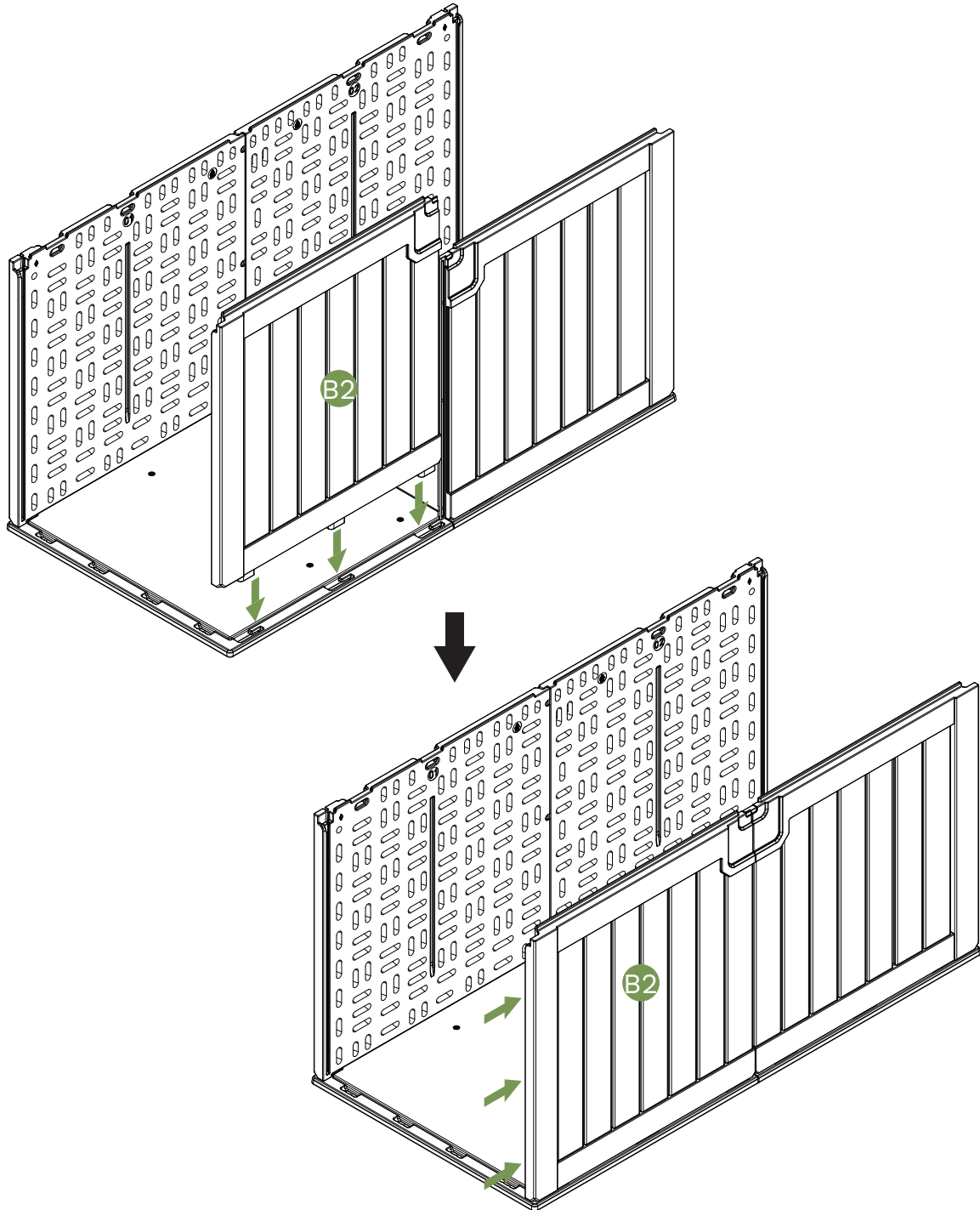

Assembly steps

Step 7

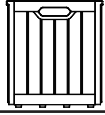

D (X2)

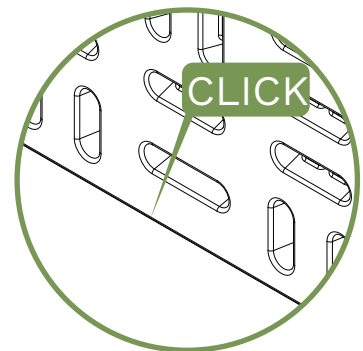
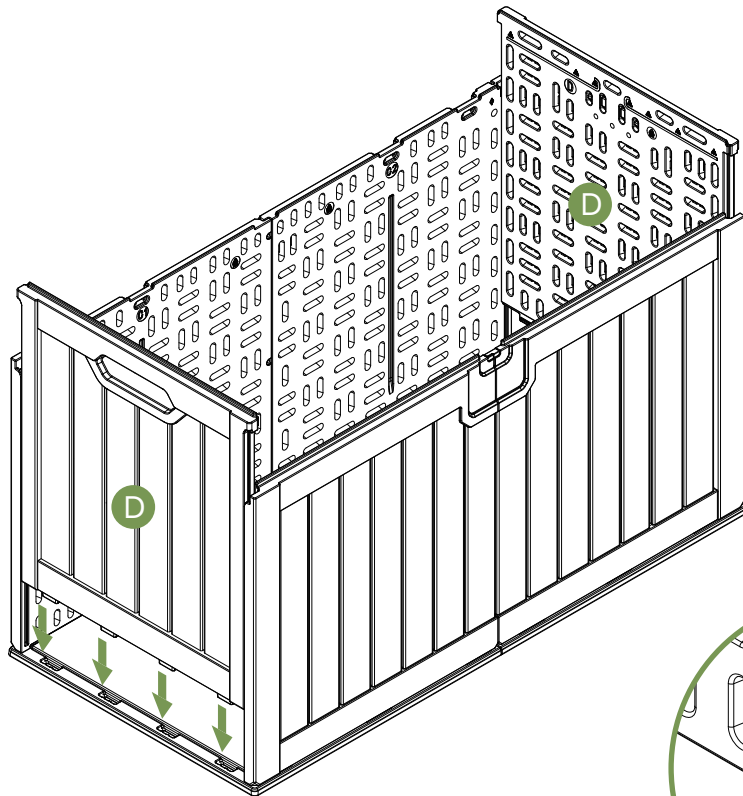

Assembly steps

Step 8

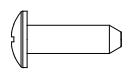
 S5 (X6)

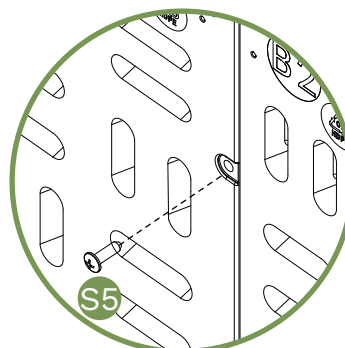
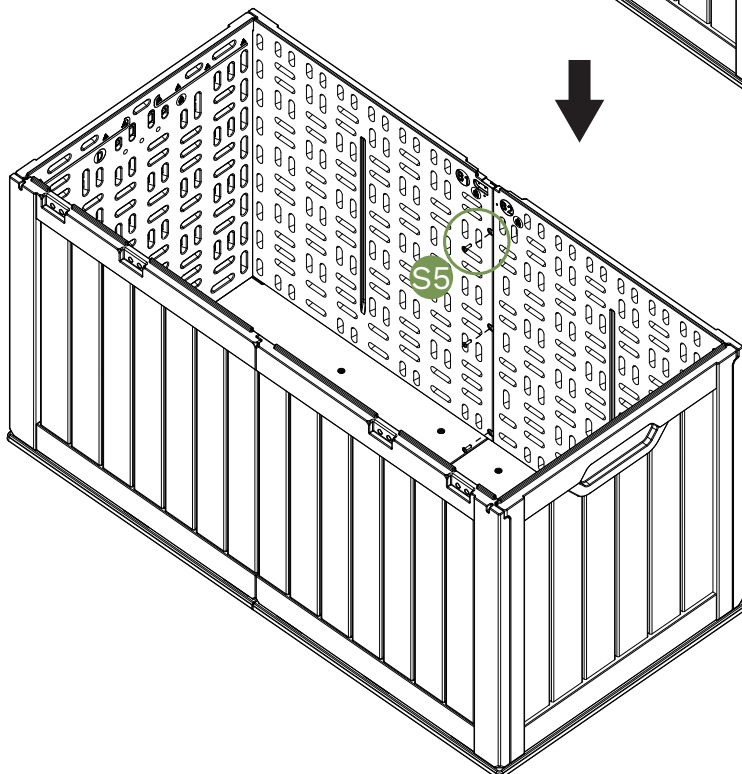
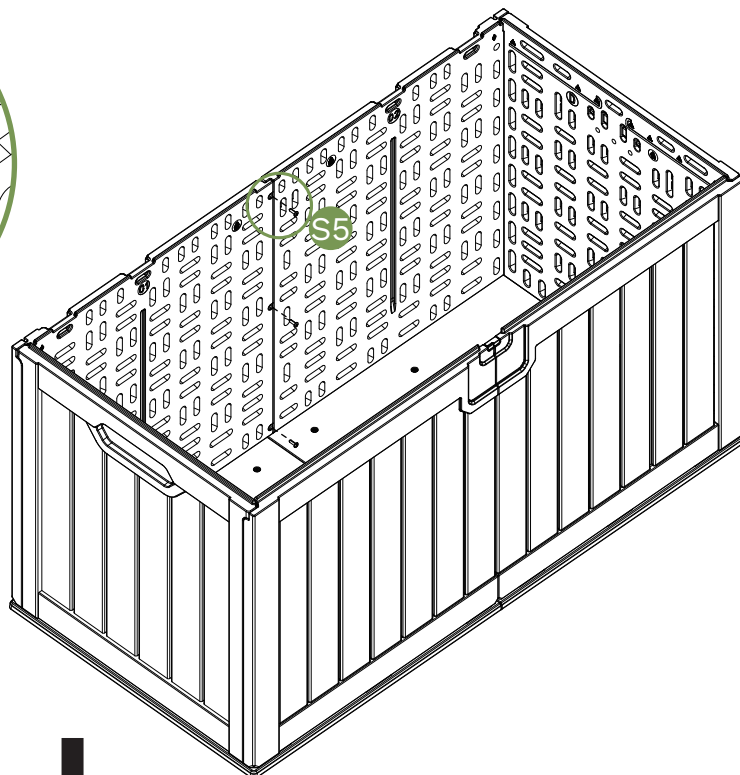
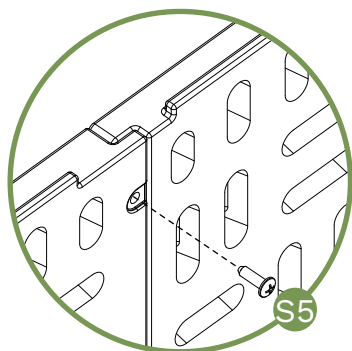

Assembly steps

Step 9



B3 (X1)



G (X1)



S6 (X4)

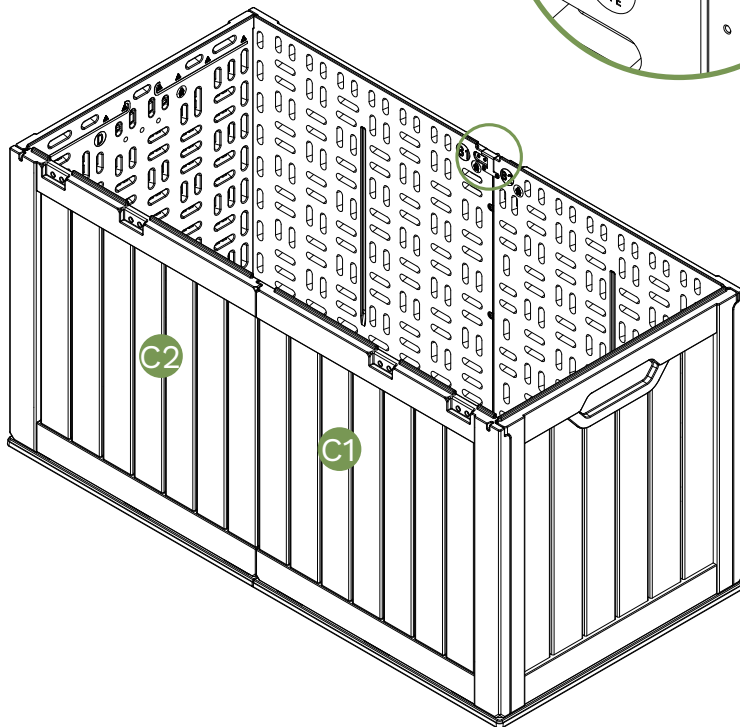
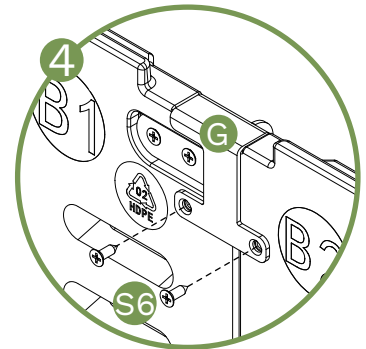
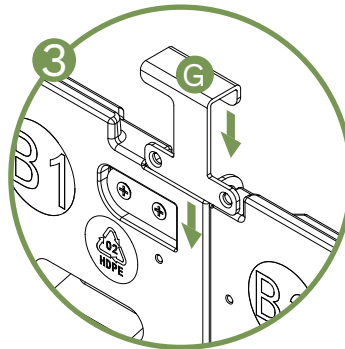
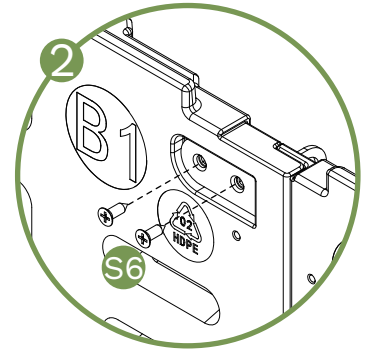
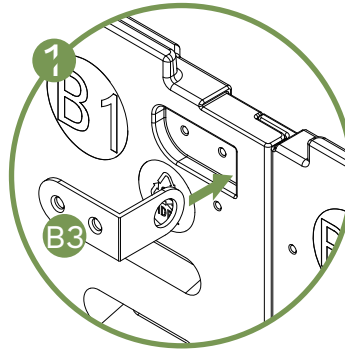

Assembly steps

Step 10

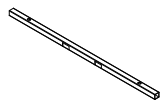

E4 (X2)

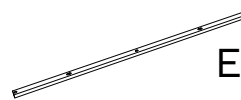

E5 (X2)

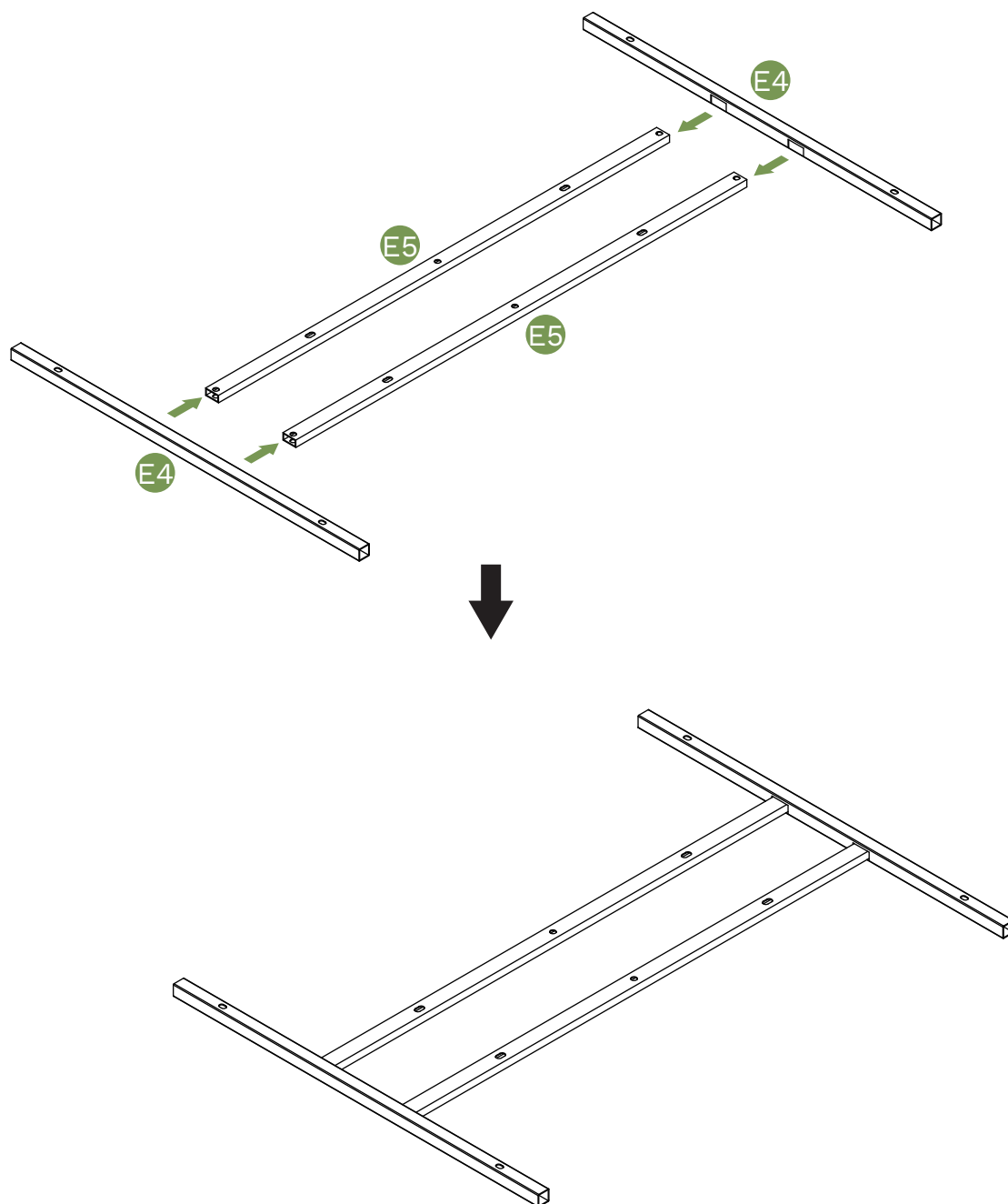

Assembly steps

Step 11

 E3 (X2)

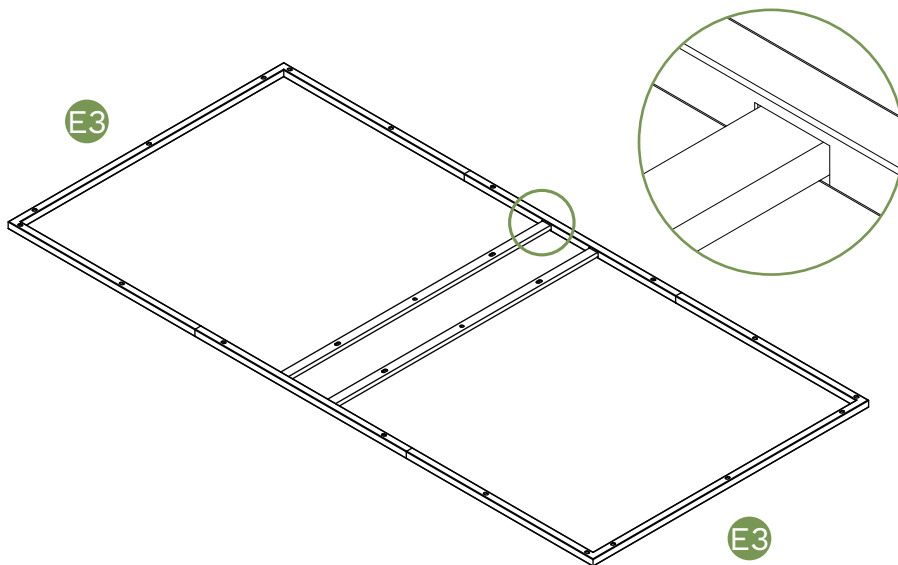
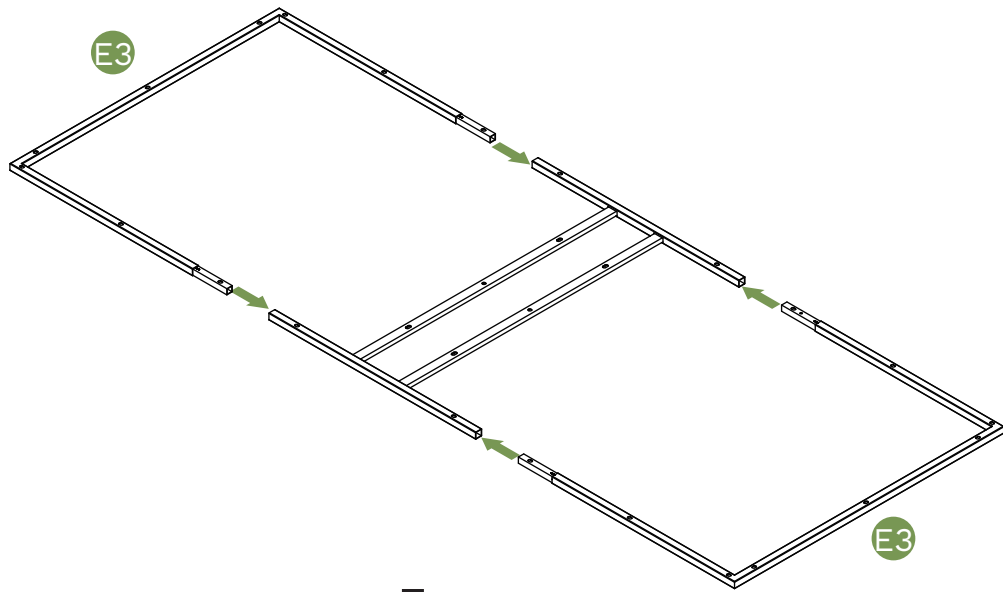

Assembly steps

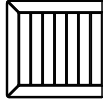
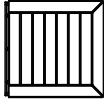
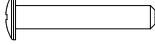
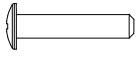
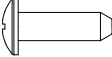

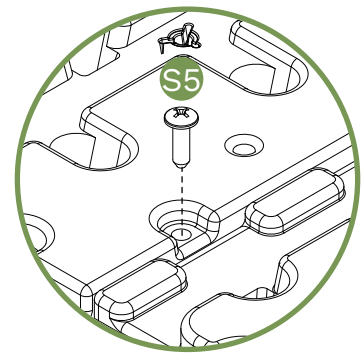
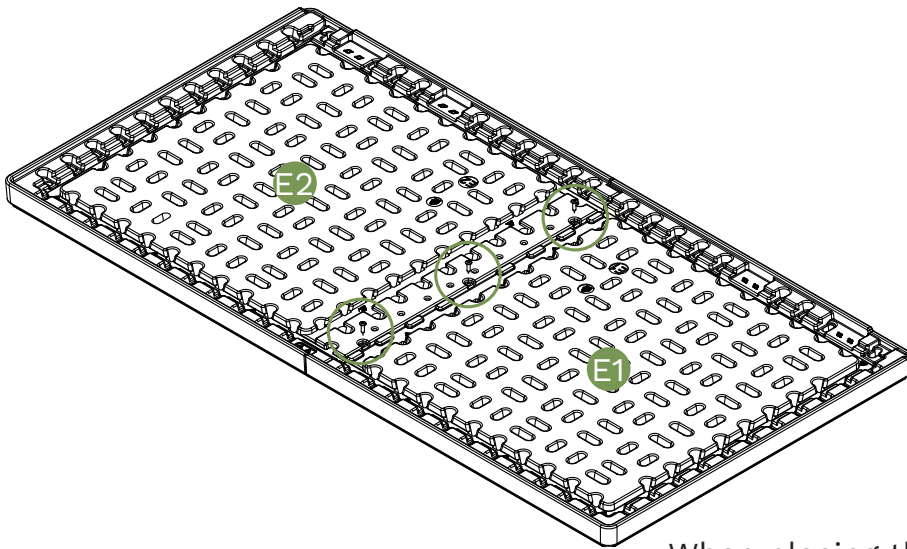

Step 12	 E1 (X1)	 E2 (X1)	 S1 (X14)
	 S2 (X4)	 S5 (X3)	

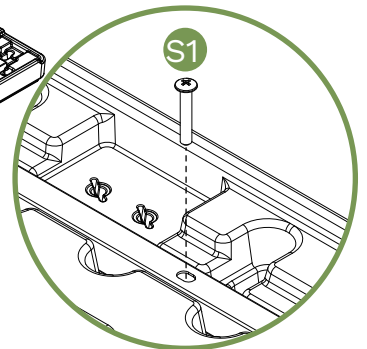
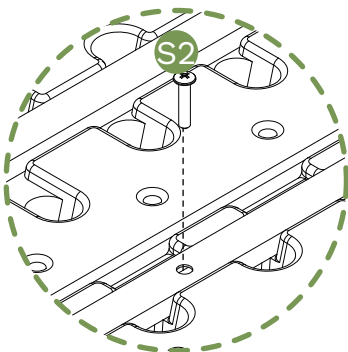
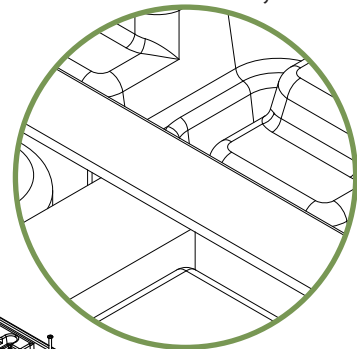
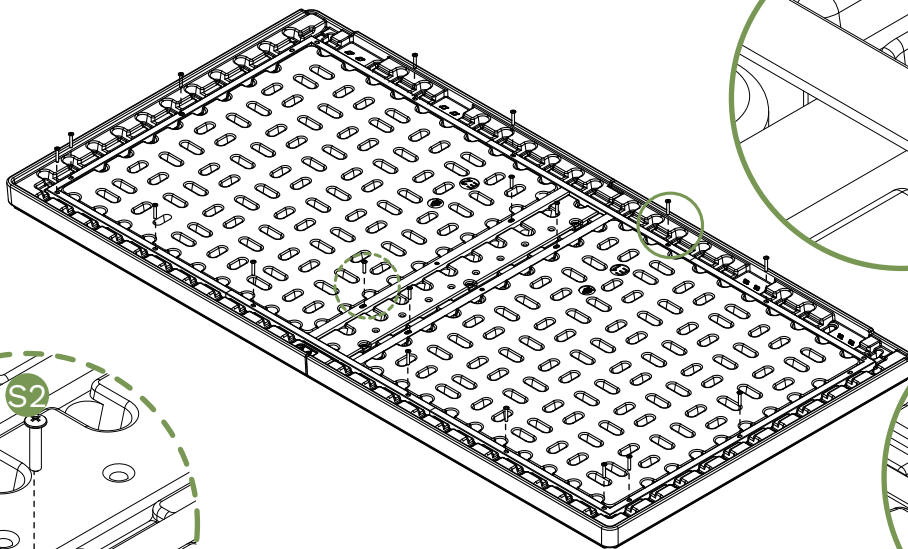

When placing the metal frame on the board, make sure it is not reversed, or the screws won't align.

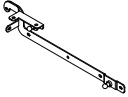
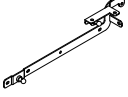
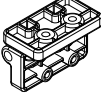

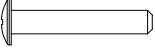
Assembly steps

Step 13	 D1 (X1)	 D2 (X1)	 H (X4)
	 B3 (X1)	 S1 (X4)	 S3 (X10)

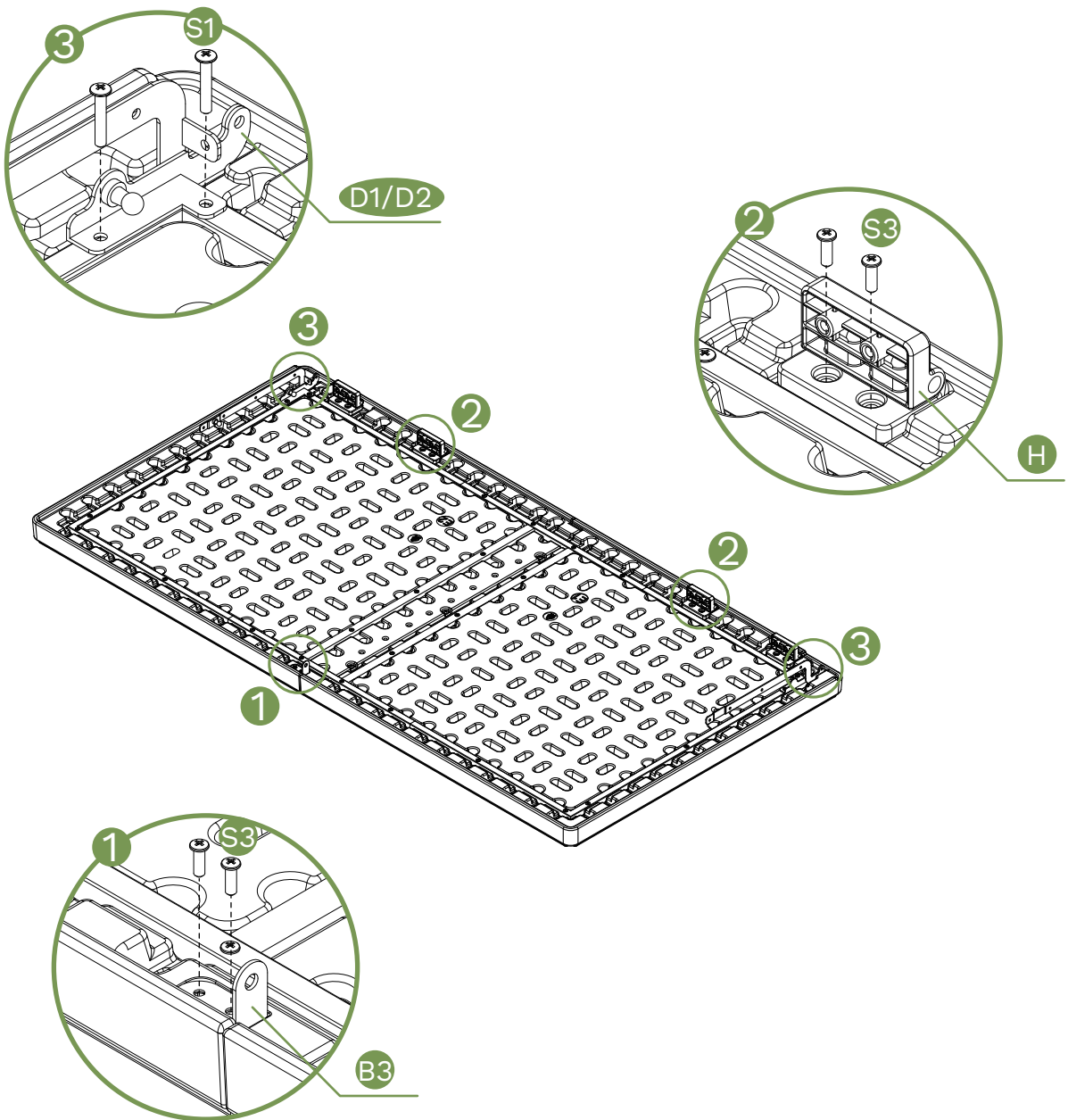

Assembly steps

Step 14



C3 (X4)



S3 (X10)

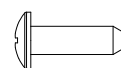

S5 (X8)

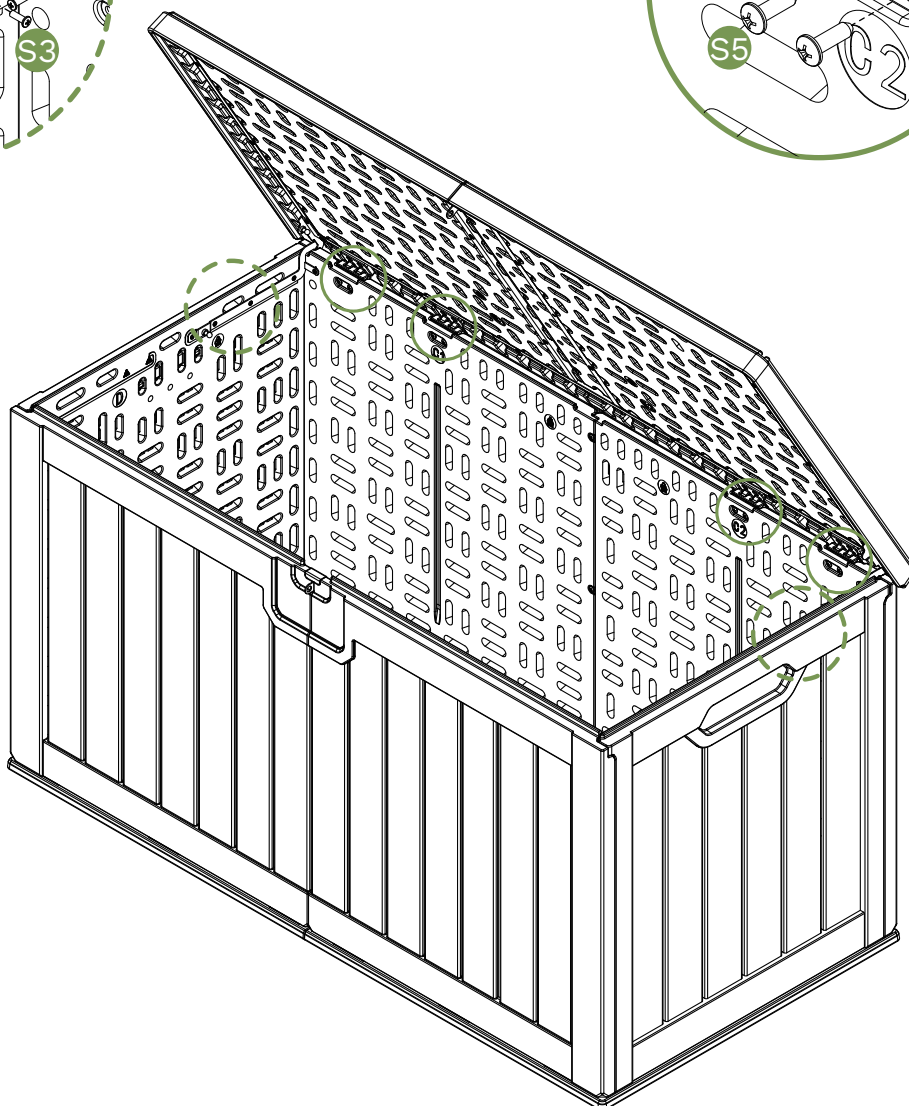
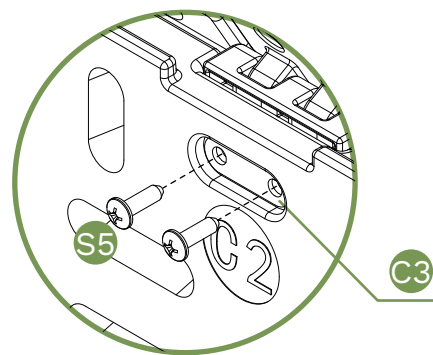
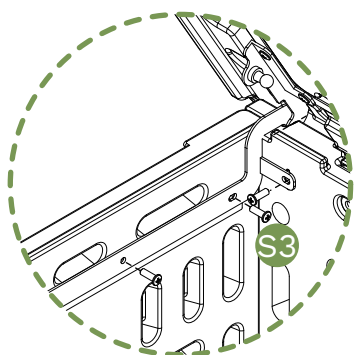

Assembly steps

Step 15

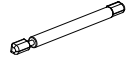

D3 (X2)

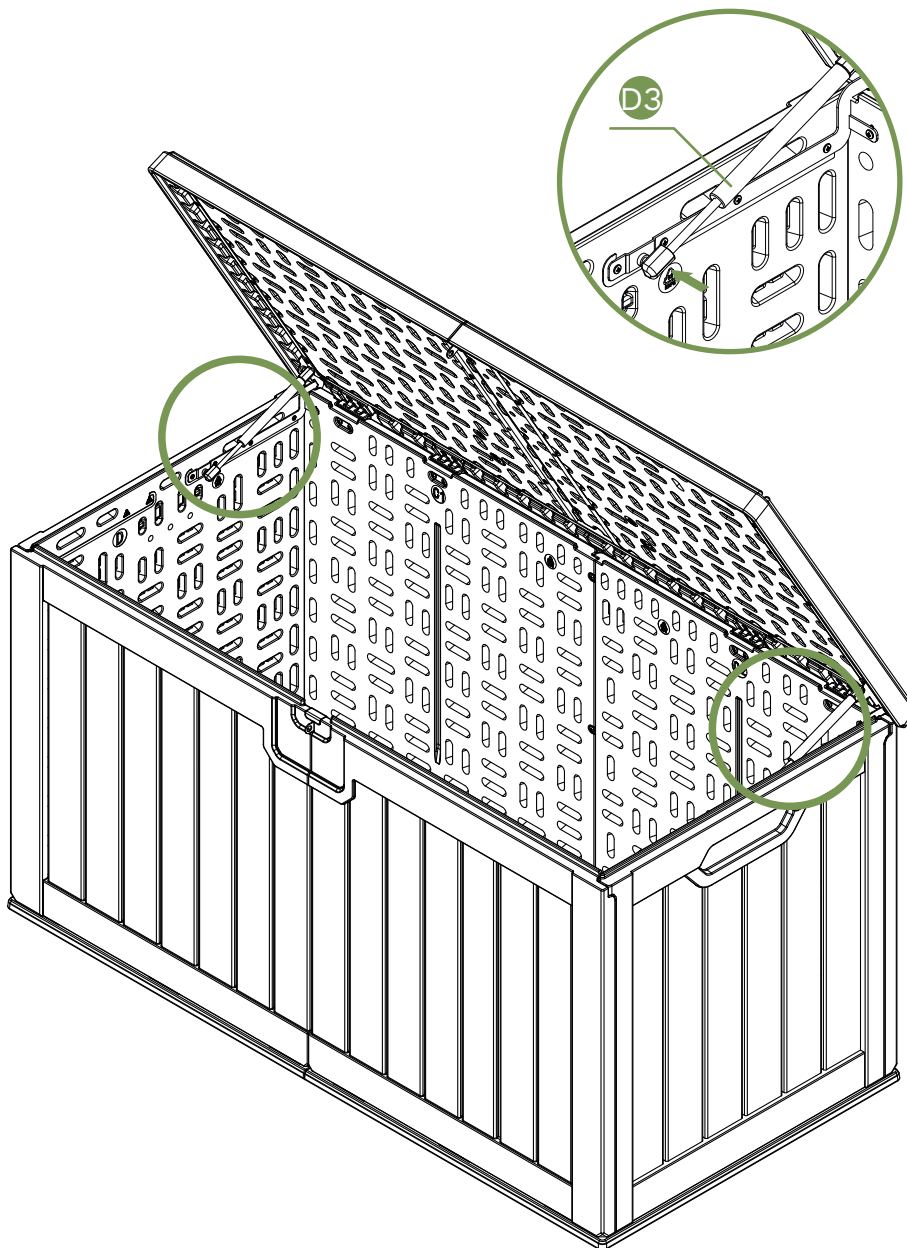

Assembly steps

Step 16

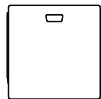

F (X1)

