

# USER MANUAL

THE NEW GENERATION SAUNA IN THE WORLD!

**CARBON ENERGI INFRARED SAUNA**

**FOR INDOOR USE ONLY**

**120VAC 20 AMP DEDICATED CIRCUIT (INFRARED 1 PERSON/2PERSON/3PERSON SAUNA)**

SAUNA: CAREFULLY AND THOROUGHLY READ THIS MANUAL BEFORE USING THE SAUNA.  
WE RECOMMEND KEEPING THIS MANUAL FOR REGULAR REVIEW AND FUTURE REFERENCE

## CONTENTS

- A. Preview
- B. General Safety Rules
- C. Installation
- D. Operation
- E. Tips for Use
- F. F. A. Q.
- G. Maintenance
- H. Transportation
- I. Limited Warranty

## WARNING

Visually inspect all heaters before assembly to make sure they are not damaged . Any excessive vibrations during transport could cause damage to the heating elements . DO NOT START the sauna if damage is detected ! Contact your dealer or manufacturer for troubleshooting and replacement parts.

## NOTE

The pictures and diagrams shown within this owner' s manual are representations of this model. Actual model may vary.

## A. PREVIEW

### A.1 Operating Conditions:

Temperature: 5°C-40°C(Fahrenheit Degree: 41-104°F)

- Humidity: W85%
- Pressure: 700-1060 hpa
- Power supply: AC115-120V, 60Hz
- The sauna cabin must be 1.38 inches away from the wall at the least.

### A.2 Features:

- Wooden construction.
- Digital microprocessor controlled.
- Temperature adjustable from 18°C-65°C.(Fahrenheit Degree:65-149°F)
- Adjustable dwell time from 0 to 90 minutes.
- Temperature sensor.
- Touch-tone keypad.
- Long-life carbon fiber heater.
- Has one ventilator on the roof.

**Before using the sauna, familiarise yourself with all safety notes and warnings included in this manual and also on the safety notices on the sauna itself.**

## B. GENERAL SAFETY RULES

### **B.1 IT IS UNLAWFUL TO INSTALL THIS UNIT WITHOUT FIRST OBTAINING A PERMIT FROM THE LOCAL ELECTRICAL INSPECTION AUTHORITY.**

- All wiring to the sauna heater and accessories shall be routed away from any direct radiation from the sauna heater.
- Any receptacle shall not be installed inside the heated room.
- The sauna heater shall not be subjected to water spray and that shower heads shall not be installed above the sauna heaters.
- No plumbing fixtures (taps, etc.) are to be installed in the sauna room.
- The door of the heated room should not include any locking or latching system, malfunction of which could cause entrapment inside the heated room.
- The dry-bath room shall be provided with intended ventilation.

### **B.2 Health Precaution**

Hyperthermia Danger: the normal body temperature can't rise above 39°C(103°F).

Symptoms of excessive hyperthermia include dizziness, lethargy, drowsiness, and fainting. The effects of excessive hyperthermia may include failure to perceive heat, physical inability to exit sauna, unawareness of impending hazard, unconsciousness and fetal damage in pregnant women. Hyperthermia could make your body's core temperature rise. Setting desired temperature to an excessively high temperature is not recommended.

**NOTE: EXIT SAUNA IMMEDIATELY IF YOU FEEL DIZZY, SLEEPY, OR ANY DISCOMFORT.**

### **B.3 Safety Precautions**

- Do NOT dry clothes or leave towels in the sauna.
- Do NOT touch the carbon heater with your finger or metal tools.
- Do NOT touch the light when it is on.
- Do NOT splash water or other liquid to the carbon heater.
- Do NOT use the sauna if you have any of the following conditions:
  1. Those with unhealed wound, eye disease or serious burn;
  2. The aged, valetudinarian and especially patients. Pregnant women and babies are prohibited;
  3. Patients with hyperthermalgesia, obesity, heart disease, hypertension, circulatory system disease or diabetes must consult the doctor before using this product.
- Do NOT place pets into the sauna.
- Do NOT use after drinking excessive alcohol.
- Do NOT instal the sauna near water ,near a bathtub ,near a shower, in a wet basement, or near a swimming pool.
- Do NOT use liquid cleaners or aerosol cleansers inside the sauna. Unplug the sauna from the wall outlet before cleaning. Use plain water and a soft cloth for cleaning.
- Do not use any wall receptacle adapter or extension cord between the sauna cord and wall receptacle.
- Children aged from 8 years old and above and persons with reduced physical, sensory or mental capabilities or lack of experience and knowledge if they have been given supervision or instruction concerning use of the appliance in a safe way.
- Sauna room is to be inspected before restarting timer.
- When replacement parts are required, be sure they meet the specified requirements of the manufacturer.
- Unauthorized substitutes may result in fire, electric shock, or other hazardous conditions. After any repairs, please ask the service technician to perform safety checks

to determine that your sauna is working properly.

- If the supply cord is damaged, it must be replaced by the manufacturer, its service agent or similarly qualified persons in order to avoid a hazard.

- Caution: The appliance is non-self-resetting thermal cut-out.











- WARNING: Do not cover.

- The heater must be used alone.

- WARNING: Connection of power line must be completed by professional electrician!

Installation of all electrical components and connections should only be performed by a suitably qualified person.

## MAIN COMPONENTS

<b>1</b> 	<b>2</b> 	<b>3</b> 	<b>4</b> 	<b>5</b> 	<b>6</b> 
FLOOR QTY1	BACK PANNEL QTY1	RIGHT PANNEL QTY1	BENCH HEATER PANNEL QTY1	BENCH SEAT QTY1	LEFT PANNEL QTY1
<b>7</b> 	<b>8</b> 	<b>9</b> 	<b>10</b> 	<b>11</b> 	<b>12</b> 
FRONT PANNEL WITH GLASS DOOR QTY1	ROOF QTY1	Dust Cover Plate	DOOR HANDLE QTY1	OXYGEN BAR QTY1	CUP HOLDER QTY1

## FIXINGS, FITTINGS AND TOOLS

					
ST*0.98"	ST*0.55"	M6*1.57"	ST*1.97"	ST*1.57"	SC*4.09"
SCREW FOR CUP HOLDER QTY2	OXYGEN BAR SCREW QTY2	WOODEN HANDLE SCREW QTY2	SCREW FOR BENCH LEG AND BENCH SUPPORT QTY8	SCREW FOR FIXED TOP QTY6	SCREWDRIVER QTY1

# C.INSTALLATION

## C.1 Installation of different type of structures

### Infrared Sauna (for 1 person)

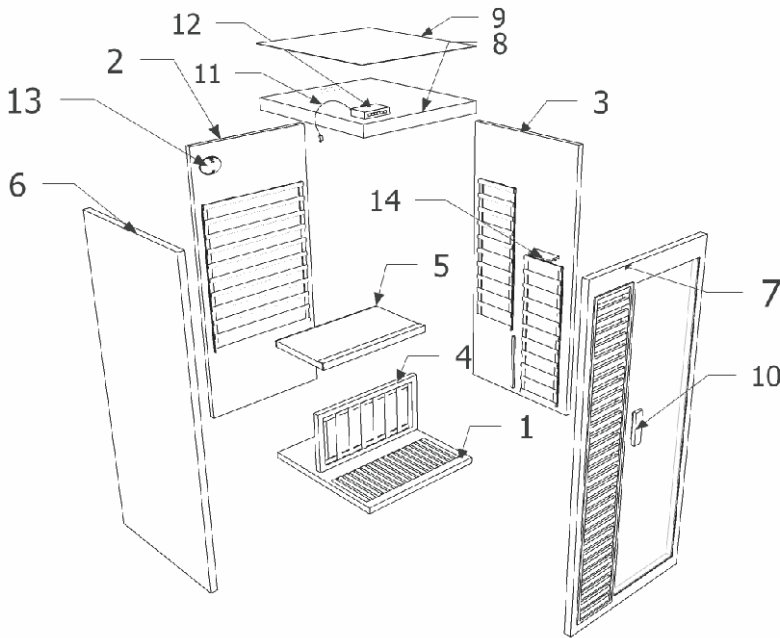

1	Floor	2	Back Panel
3	Right Panel	4	Bench Heater Panel
5	Bench Seat	6	Left Panel
7	Front Pannel With Glass Door	8	Roof
9	Roof Cover	10	Door Handle
11	Power Cord	12	Power Box
13	Oxygen Bar	14	Cup Holder

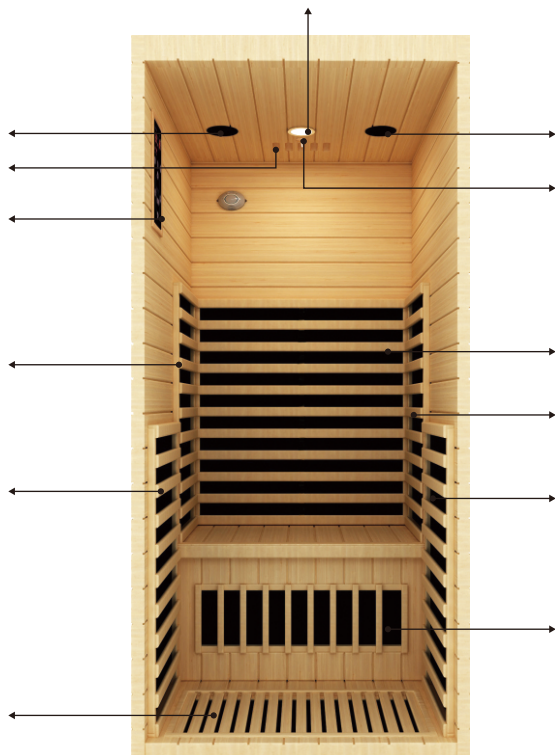

15	Reading Lamp	16	Right Speaker
17	Left Speaker	18	Ventilation window
19	Temperature Sensor	20	Controller Panel
21		22	
23		24	
25		26	
27			

## Infrared Sauna (for 2 person)

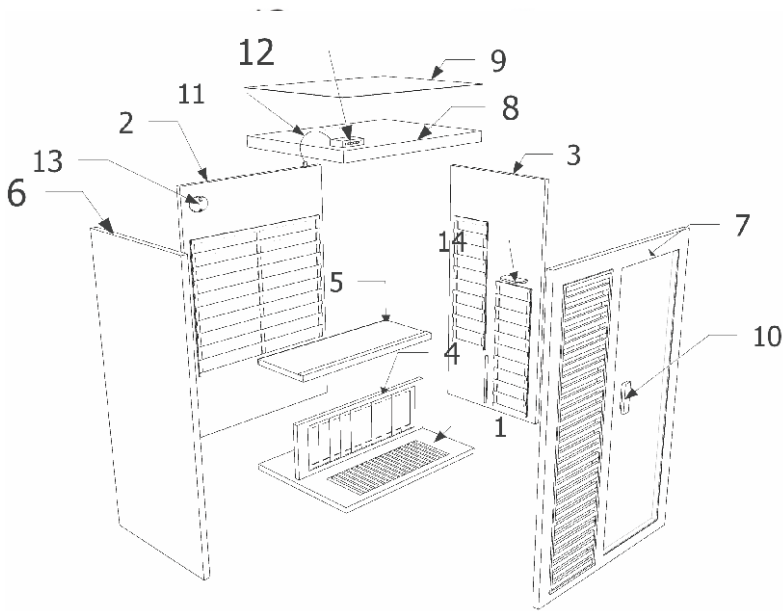

1	Floor	2	Back Panel
3	Right Panel	4	Bench Heater Panel
5	Bench Seat	6	Left Panel
7	Front Pannel With Glass Door	8	Roof
9	Roof Cover	10	Door Handle
11	Power Cord	12	Power Box
13	Oxygen Bar	14	Cup Holder

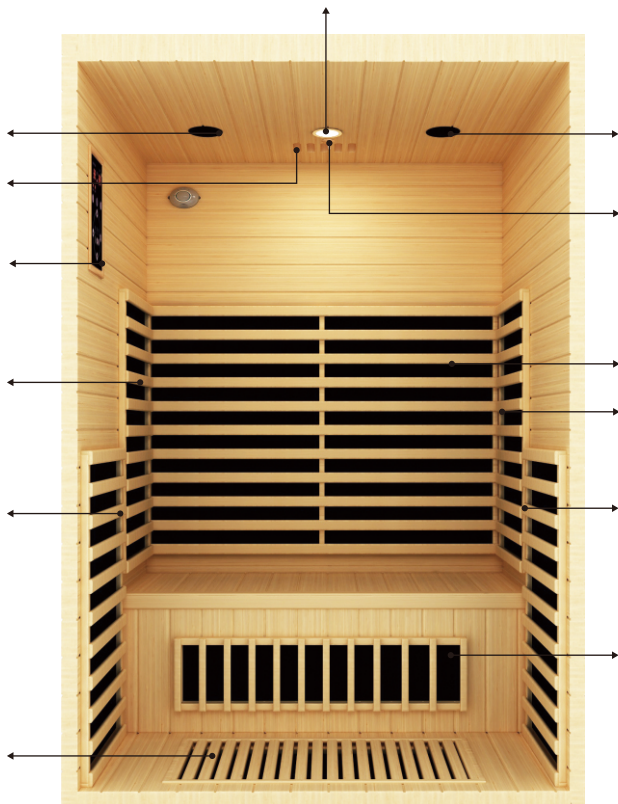

15	Reading Lamp	16	Right Speaker
17	Left Speaker	18	Ventilation window
19	Temperature Sensor	20	Controller Panel
21		22	
23		24	
25		26	
27			

## Infrared Sauna (for 3 person)

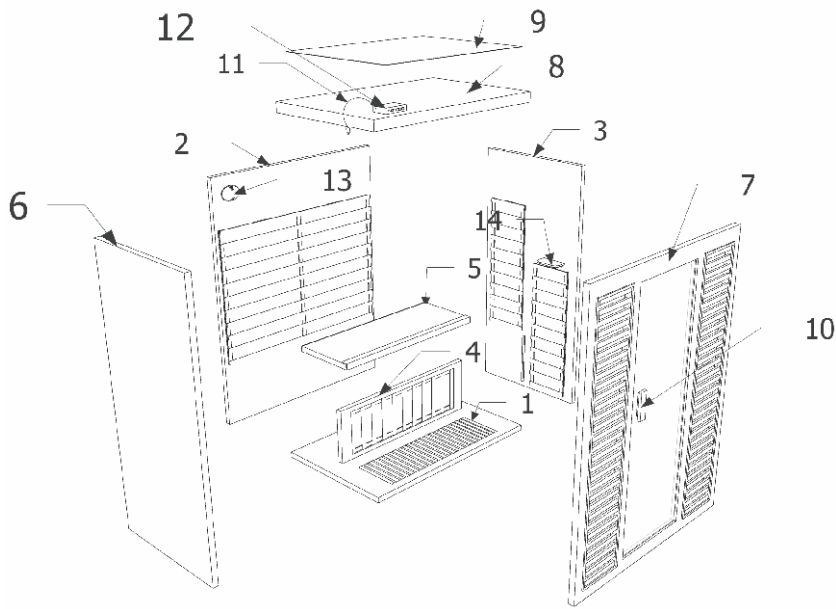

1	Floor	2	Back Panel
3	Right Panel	4	Bench Heater Panel
5	Bench Seat	6	Left Panel
7	Front Pannel With Glass Door	8	Roof
9	Roof Cover	10	Door Handle
11	Power Cord	12	Power Box
13	Oxygen Bar	14	Cup Holder

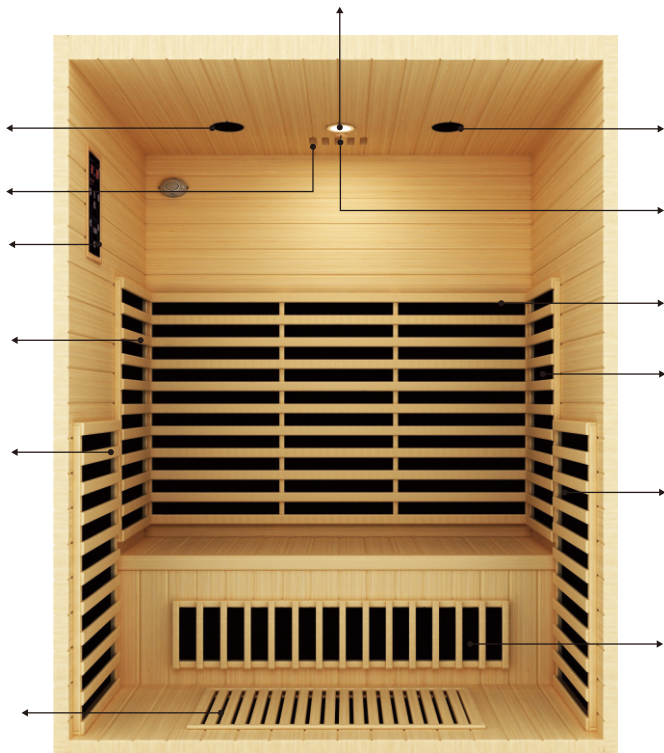

15	Reading Lamp	16	Right Speaker
17	Left Speaker	18	Ventilation window
19	Temperature Sensor	20	Controllor Panel
21		22	
23		24	
25		26	
27			

## Assembly diagram



**Step 1: Install Bottom**



**Step 2: Install Back Panel**



**Step 3: Install Left Panel**



**Step 4: Install Right Panel**



**Step 5: Install Seat Support**



**Step 6: Insert Plug (Leg+Foot Heating)**



**Step 7: Install Seat**



**Step 8: Install Front Panel**



**Step 9: Install Top Panel**



**Step 10: Install Handle**

## C.2 Circuit Diagram

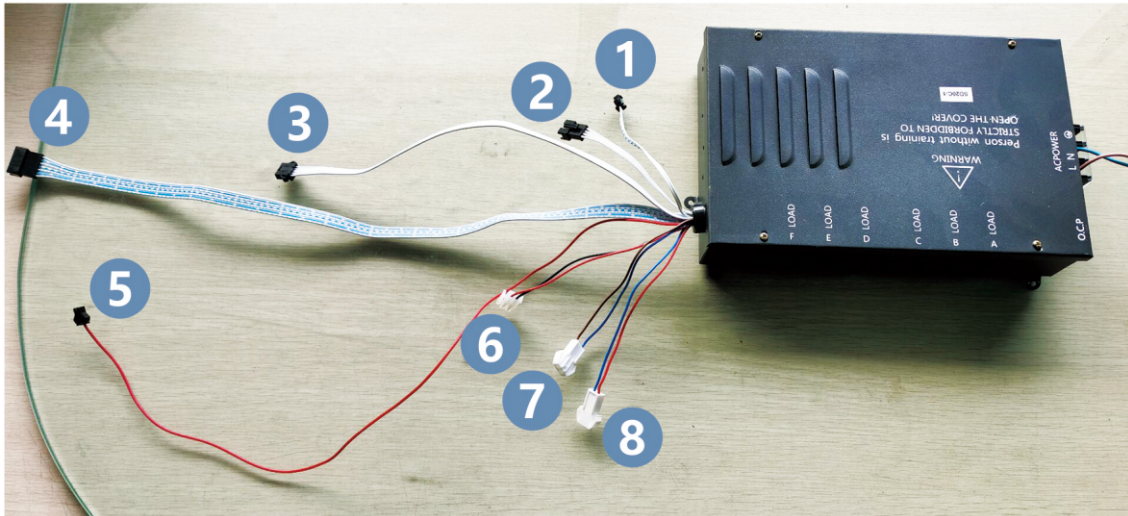

1	Temperature Sensor	2	Speaker
3	Color Light	4	Control Line

5	Antenna	6	Oxygen Bar Line
7	Roof Light Line	8	Internal Light Line

This circuit diagram is applicable to

### C.3 Attention before installation

- Do not share the same plug with other appliances.
- Position it on a flat level surface.
- Do not splash the exterior with water. If the floor is damp, install a floor separator to keep the sauna dry & high.
- Do not store the flammable objects or chemical substances near the sauna.

### C.4 Details during installation

- Place the Bottom Panel on level ground and keep the right the side up.

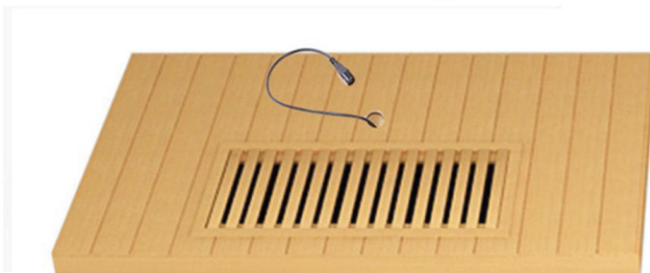

- Fasten the sauna plate with hasp.



- Seat Support Installation



- Seat Installation



- Remove the dust cover as shown in Figure 1.

**Figure 1**



- Secure the top with screws at the locations indicated by the red circles in Figure 2.

**Figure 2**



- Connect the sauna room box (heating element) power plug to the top power plug in Figure 3

**Figure 3**



- Connect the wires from the controller and power box in Figure 4

Figure 4

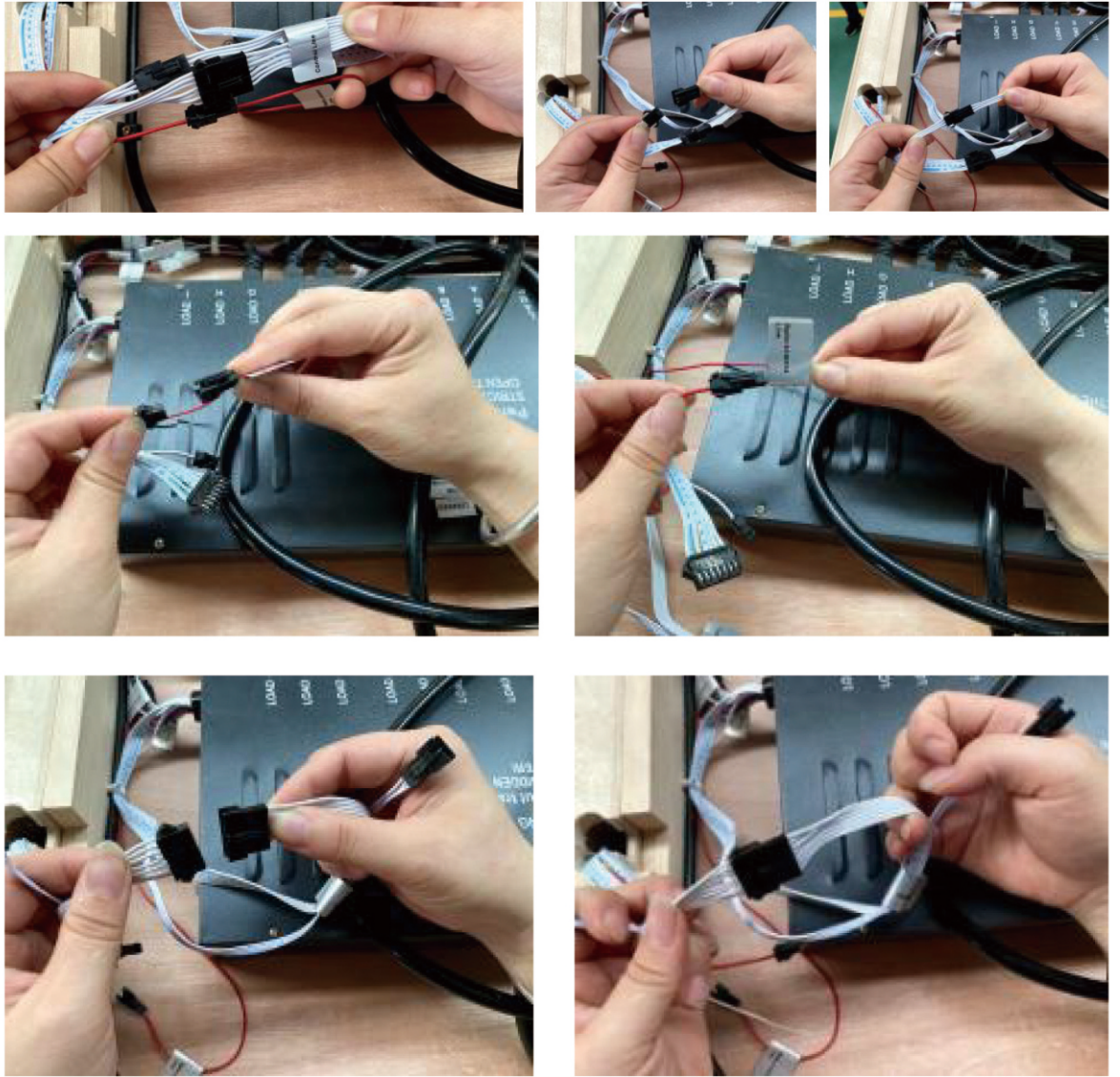

- Install the top cover (please note that the power cord should be kept above the dust cover, as shown in Figure 5, with the power cord positioned as indicated by the red circles)

Figure 5

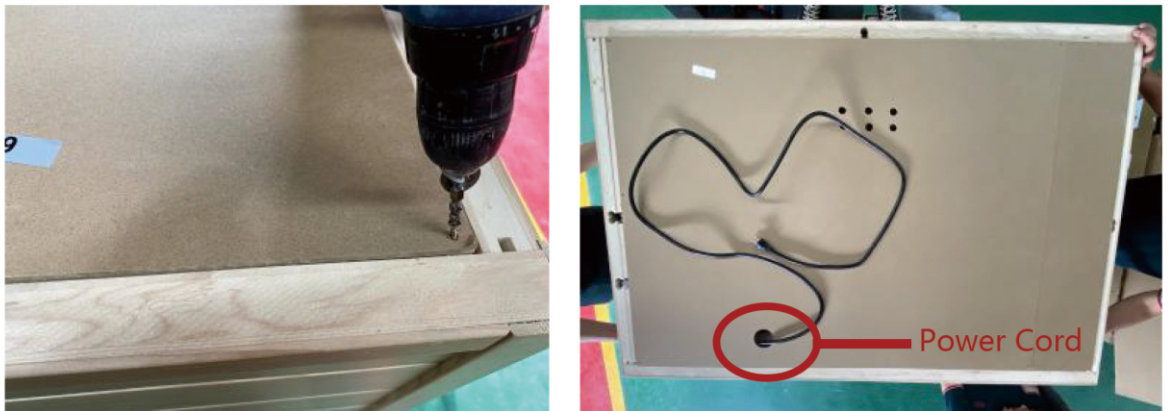

- Installing cup holder.

Attach cup holders in the fore left corner and the fore right corner (when sitting in the sauna).



- Installing doorknob.

1. Align the inside doorknob against.

2. Holes on the inside of the door. Hold it at an angle against the door.

3. Insert the screw into the hole located on the inside of the door. Screw until it is tightly fit.



### C.5 How to replace the heater

Warning: only qualified person can replace the heater.

- How to replace the carbon fiber heater:

**1** Take off wooden frame of carbon heater, then screw off carbon heater from wooden frame.

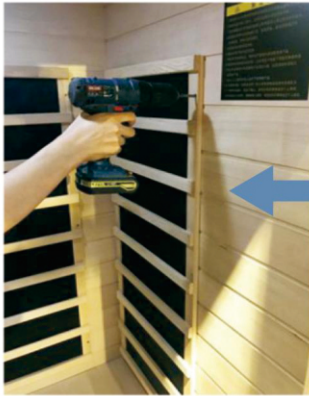

Take off this wooden cover for screw firstly.

**2** Take out carbon heater carefully. Find out the connector between carbon heater and sauna wall.



**3** Disconnect the connector between carbon heater and sauna wall.



**4** Repace with a new carbon heater. Screw it into wooden frame. Then plug in the connector from carbon heater and sauna wall.

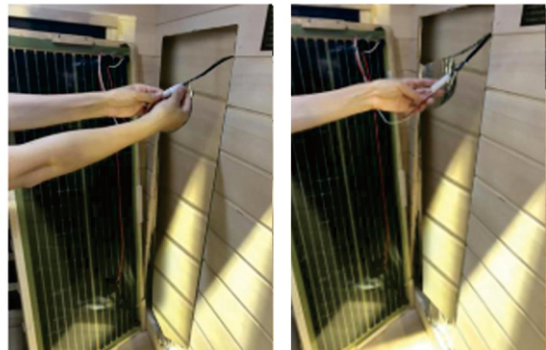

**5** Screw wooden frame of carbon heater to sauna wall and cover the screw hole with original wooden cover.



## C.6 Oxygen Ionizer Installation

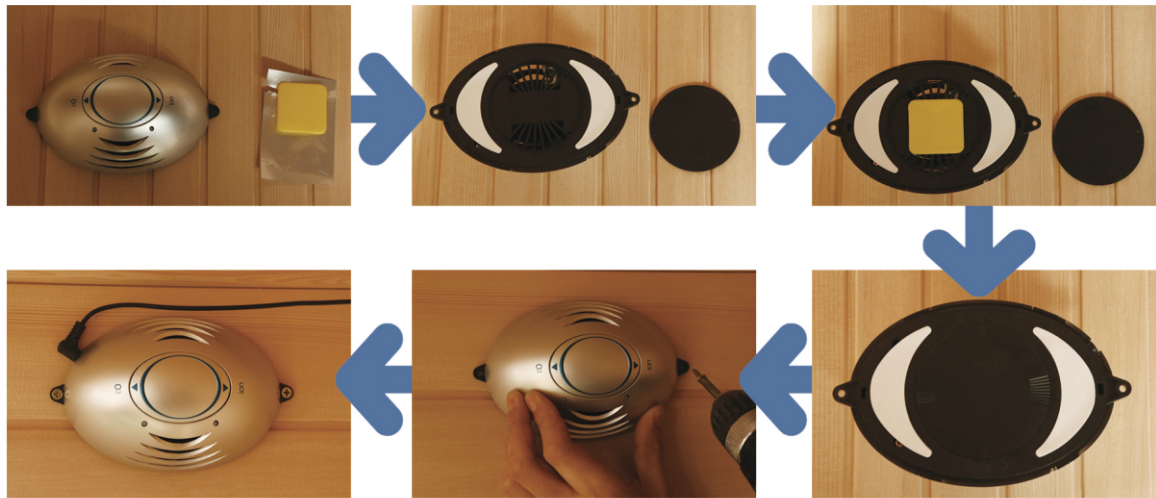

- Press the ion button: it extremely purifies the air and removes toxic substances including the dust and odors mold.
- Press the ozone button: ozone may kill virus, and will be deoxidized into oxygen in the end without secondary pollution, which the chemical agents can not achieve.



### SPECIFICATION

MODEL: -----DY13A  
 OZONE OUTPUT: ----->5MG/H  
 RATED VOLTAGE: -----DC-12V  
 POWER CONSUMPTION: -----5W  
 DIMENSION: -----4.72"\*3.54"\*6.93"  
 ANION DENSITY: ----->1\*106PCS/CM3

- Operating instruction: anion and ozone can only work separately; when the ozone starts to work the anion will stop; after about 15 minutes working the ozone will stop; and turn the anion function automatically.

## D.OPERATION

**NOTE:** Before the sauna is turned on, remove plastic protective covering from the CONTROL PANELS. Please check and confirm that the connections to the POWER SUPPLY, HEAT EMITTERS, and TEMPERATURE SENSOR are connected properly. The power supply voltage and frequency must match the requested voltage and frequency of the sauna (120VAC 20AMP Dedicated Circuit).

### D.1 In use of sauna room

Please pull the temperature sensor vertical downward, as shown in the figure below to ensure the accuracy of the temperature display on control panel.

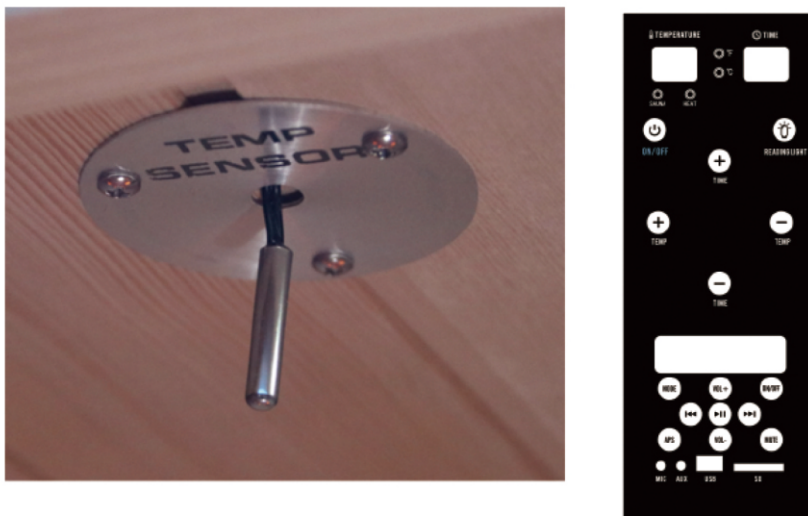

### D.2 Plug the power cord into the wall outlet.

please refer to the socket usage in the picture type for reference





### Important Electrical Installation Information for Your Sauna:

#### a. Special Electrical Outlet Requirement:

Your new sauna is a high-power device that operates at 120V and requires 20A (120V/20A). It necessitates the use of a matching 120/20A electrical outlet to function safely and efficiently. This specific requirement is beyond the capacity of standard household outlets.

#### b.Type of Outlet Needed:

The sauna must be connected to a dedicated 120/20A outlet. This specialized outlet is crucial for accommodating your sauna's high-power requirements and ensuring operational safety.

#### c.Professional Installation Is Required:

**Do Not Attempt DIY Installation:** Given the high-power specifications of your sauna, the installation of the 120/20A outlet must be performed by a qualified and licensed electrician. This step is vital for your safety and the correct functioning of the sauna.

**Why Hire a Professional Electrician?** An electrician will install the outlet in compliance with safety standards, ensuring that it can safely handle the power demands of your sauna. This expertise not only prevents potential electrical hazards but also assures the longevity and performance of your sauna.

#### d.Before Using Your Sauna:

Verify that the electrician has installed the dedicated 120/20A outlet.

Have the electrician confirm that the outlet is operational and matches the specific requirements of your sauna.

Do not use any form of adapter or attempt to alter the sauna's plug to fit a different outlet type.

#### e.Safety Notice:



Adhering to these guidelines is not merely a recommendation—it is imperative for your safety and to ensure that your sauna functions optimally. Incorrect power supply or installation can lead to safety hazards and affect the sauna's performance.

If you have any uncertainties or require further assistance, please contact our customer support. We are committed to ensuring that you have a safe and enjoyable sauna experience.



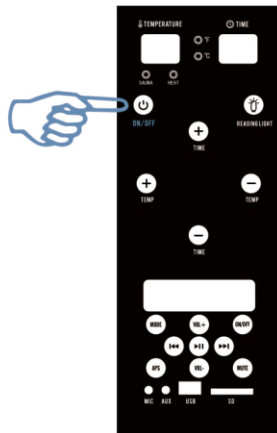

### D.3 Operation of control panel

a. Press the key . The power indicator turns on. Temperature display indicates the temperature in the room. Press the key again . The power indicator turns off.

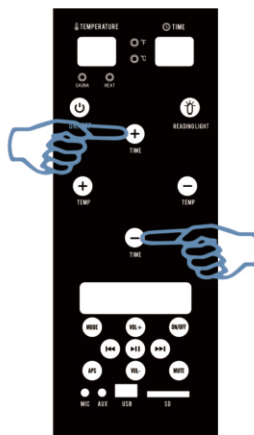

b. Press the key  or  to adjust the time. If the time indicates 00, the room stops heating.





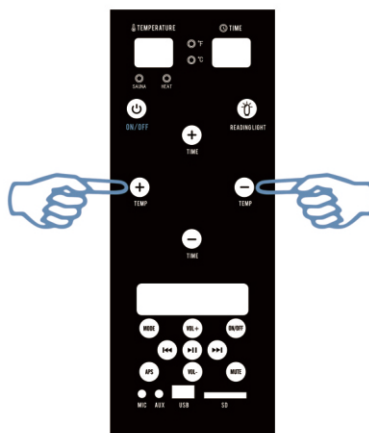

c. Press the key   together is F/C, the heat indicator turns on. The sauna will automatically start by pressing the key  or  on the left to adjust the temperature.

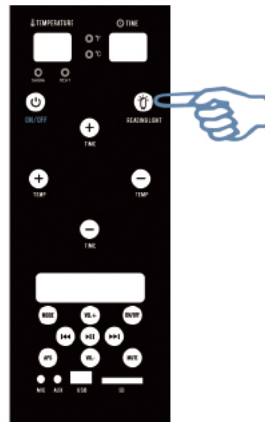





d. Press the key  turn on the light in or out of the room. Press them again, the lights will be turn.

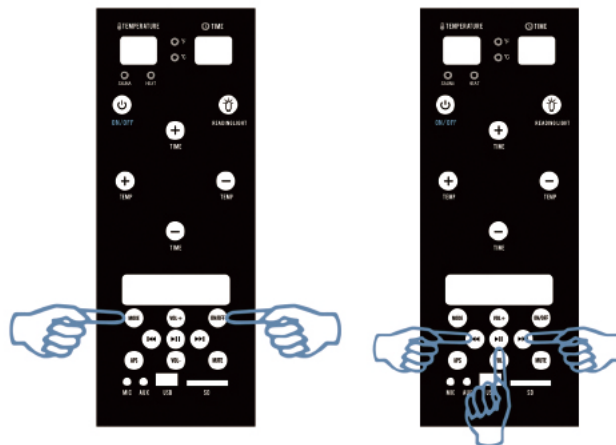

e. Press the key  to turn on/off the music. Press the key  to choose AM/FM and bluetooth (Bluetooth Name:G\_811). Press the key  to choose the last song. Press the key  to choose next song. Press the key  to stop the song.



f. Press the key  to increase the volume. Press the key  to decrease the volume. Press the key  and  to answer the telephone.

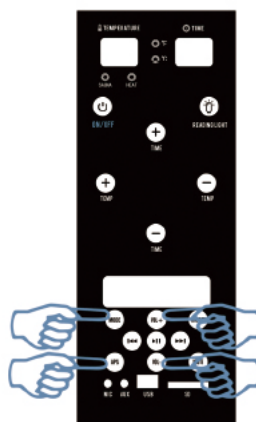

#### D.4 Open the ceiling vent to allow a flow of fresh if required.



## E.TIPS FOR USE

- Please note that this product is a dry steam sauna room with no water. Place the sauna room in a dry area, and ensure there is at least a 1-inch gap between the bottom of the sauna room and the floor to allow for ventilation. Do not place the sauna room on blankets or any material that may block the bottom of the sauna room.

- To ensure the safety and optimal performance of the sauna room, please adhere to the following guidelines:

Do not modify the power cord: The provided power cord is specifically designed for safe operation. Any modification, cutting, or alteration of the power cord may pose safety risks and could void the warranty.

Avoid using extension cords: We strongly advise against using extension cords with this product. Extension cords may lead to a drop in power voltage, resulting in decreased performance and potential safety risks. If you need extended coverage, please contact our customer service for recommended solutions.

Failure to comply with these rules will result in self-assumed responsibility for any issues, and the warranty will be automatically voided.

- Set the temperature to a comfortable level, normally 40 to 50°C.(104 to 122°F)
- Allow approximately 8-15 minutes for the sauna to warm up.
- Perspiration will begin within 6 to 15 minutes after stepping into the unit. We recommend a sauna session does not exceed 30 minutes.
- When the temperature reaches the level set on the thermostat, the heaters will turn off and on periodically to maintain the desired temperature level inside the sauna.

- The front door/window/ceiling vent can be opened at any time to allow fresh air into the room.
- Drink plenty of water before, during and after a session to replenish lost fluids from the body.
- Taking a hot shower or bath before the sauna session will further accelerate perspiration. However, do dry off thoroughly before entering, for excessive water will stain or warp the wood. A shower latter is refreshing.
- To absorb perspiration and keep the sauna tidy, place a towel on the bench and floor of the sauna. Keep one towel handy to wipe out sweat from the body.
- Do not eat at least an hour before your sauna session. It is better to go in a sauna with an empty stomach.
- Do not use the sauna immediately after the strenuous exercise.
- Any area you want to achieve a deep heating should be moved close to the heaters. But never allow any part of the body to come into direct contact with the heater.
- After the session is over, do not immediately getting out. Let the body sweat a little more. Then, take a warm shower and finish it off with a cold shower to cool off completely.

## F.FREQUENTLY ASKED QUESTIONS

MAKE SURE TO SHUT OFF THE ELECTRICITY BEFORE DOING IT.

If the supply cord is damaged, it must be replaced by the manufacturer, its service agent or similarly, qualified persons in order to avoid a hazard.

### F.1 Heater has problem.

Problem	Explanation	Solution
Heaters are still working When set time is up.	Power board and control panel broken.	Replace with a new power board and control panel.
All or parts of heaters working before you turn on the power, when you plug the power cord.	Power board broken.	Replace with a new power board.

### F.2 The control panel does not work.

Problem	Explanation	Solution
The power indicator isn't on.	The fuse is broken or the sauna is not plugged in.	Change the fuse or the plug in the sauna.
The soft keys do not work.	Unplug sauna, wait a minute or plug back into power source.	

### F.3 The interior reading light doesn't work.

Problem	Solution
The bulb filament is burned out.	Change the bulb ( $\cong$ 15 watt)

### F.4 The carbon heater not heat. (Warning: only qualified person can replace or repair the heater)

Problems	Explanation	Solution
Part of the heater does not warm up.	The heater is defective.	Replace with a new heater.
	Part of the heater is not connected well or burned out.	Connect them tightly.
The entire room does not heat.	The relay is damaged.	Replace the relay.
	The control panel is damaged.	Replace the control panel.
	The plug is not plugged in correctly.	Re-plug it.
Bench heater does not heat.	It is not connected tightly into the outlet on the back panel.	Connected tightly.

## G.MAINTENANCE

- Clean the sauna room with a soft wet cloth. NEVER use petrol, alcohol, benzene or any other such chemical to clean the unit.

## H.TRANSPORTATION AND STORAGE

- Avoid exposure to rain, snow or strong collisions during transport.
- Do not store in damp environments.

## I.LIMITED WARRANTY

- Vente Unique warrants the sauna to be free of defects in material and workmanship.
  - ※Heaters-----12 months
  - ※Workmanship-----12 months
  - ※Electrical Components-----12 months
- This warranty extends only to the original retail purchaser of the sauna and terminates upon transfer of ownership. Freight charges to and from the customer are the responsibility of the customer. This includes freight charges for parts shipped to enable the services of your sauna.
- This warranty is void if the sauna has been altered, misused, or abused. Such instances shall include operation or maintenance of the sauna in deviation to the published instructions. The warranty extends only to the manufacturing defects and does not cover any damages resulting from mishandling of the product by the owner.
- **Disclaimers**

We shall not be liable for loss of use of sauna or other products or other secondary or incidental or consequential costs, expense or damages-which may include the removal of permanent deck or other custom fixtures or the necessity for crane removal-arising directly or indirectly out of the use or inability to use the product. Any implied warranty shall have duration equal of the applicable warranty stated above. Under no circumstances shall or any of its representatives be held liable for injury to any person or damage to any property, however arising. Specifications are subject to change without notice or obligation.

- This sauna is for INDOOR use only. Placing your sauna outdoors will VOID this warranty. Any damage due to exposure to outdoor elements such as rain, snow, sun, wind or extreme temperatures will not be covered by this warranty. Any damages as a

result of modifications made to the sauna or its components will void this warranty. Surface cracks are not considered defects in material or workmanship, as they are normal characteristics of all woods. This includes minor cracks due to wood expansion and contraction.

**Note: Since the wood used in construction has been kiln dried, a certain amount of expansion and contraction occurs in the wood in a sauna environment.**

For your record, please complete the following information. You need to refer to these information when calling the us for customer service.	
Date of purchase	
Date of delivery	
Model number	
Serial number	
Dealer information (name & phone)	

## AFTER SALES SUPPORT /PRODUCT RETURNS

If you have questions regarding the operation of your purchase, or in the unlikely event you need to return the unit because it is faulty or is no longer wanted, please contact our product returns department at Customer Service

## DISPOSAL



This marking indicates that this product should not be disposed with other household wastes. To prevent possible harm to the environment or human health from uncontrolled waste disposal, recycle it responsibly to promote the sustainable reuse of material resources. To return your used device, please use the return and collection on systems or contact the retailer where the product was purchased. They can take this product for environmental safe recycling.

## CERTIFICATION

