

Hall Tree

Assembly Instructions - Please keep for future reference

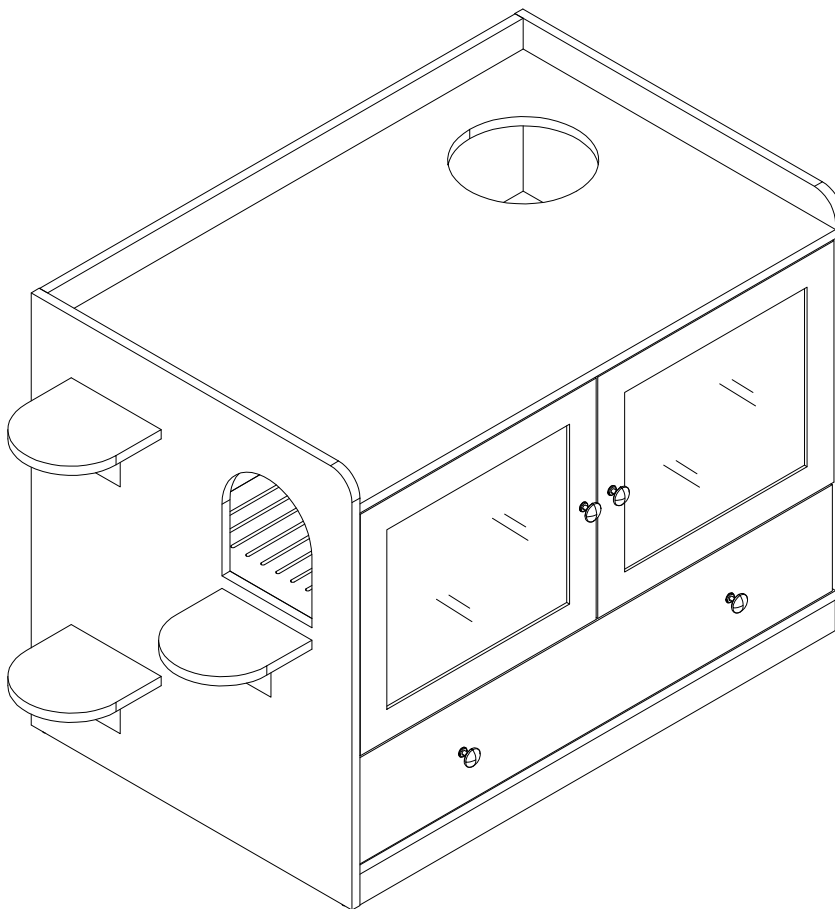

Important-Please read these instructions fully before starting assembly

Safety and Care Advice

Important – Please read these instructions fully before starting assembly

- Check you have all the components and tools listed on the following pages.
- Remove all fittings from the plastic bags and separate them
- Keep children and pets away from the installation area, which may cause choking if small parts are swallowed.
- Make sure you have enough space to layout the parts before

- Do not stand or apply weight to the product during assembly. This may cause damage.
- Assemble the item as close to its final position (in the same room) as possible.
- Assemble on a soft level surface to avoid damage to the unit or floor.
- It's easier for two people to assemble the parts together.



- To reduce the likelihood of damage to your product, make sure your power drill is set to a low torque setting.

Care and maintenance

- Only clean using a damp cloth and mild detergent, do not use bleach or abrasive cleaners.
- Check for loose screws on this unit from time to time.
- This product should not be discarded with household waste. Take to your local authority waste disposal centre.

Handy Hints

- Assemble all parts and bolts loosely during assembly, only once the product is complete should you fully tighten the bolts
- Regularly check and ensure that all bolts and fittings are correctly tightened.

WARNING In order to help prevent overturning – please follow these instructions

To help prevent product toppling over please follow the below steps:-

Use the anti tip strap or wall fixing method provided (if applicable)
Do not allow children to climb or hang on the furniture
Do not open more than one drawer at a time
Do not place heavy items in the top drawers
Do not place heavy items on top of the furniture, unless the furniture has been designed for this purpose

please note that only the anti tip strap is provided.
You will need to provide wall plugs and screws applicable for your wall type

Using Camlocks

Step 1

Connect the male camlock as directed in the assembly instructions using a screwdriver.

1 DO NOT OVER TIGHTEN.

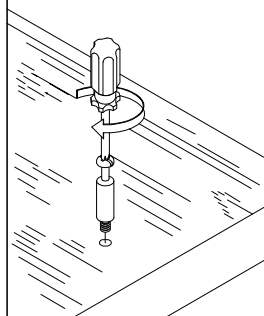

Step 2

Push the male camlock into the entry hole.

2

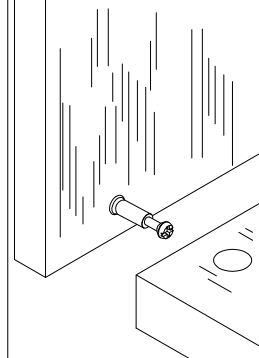

Step 3

Insert the female camlock as shown in the instruction.

Note: ensure that the arrow on the top of the camlock points towards the entry hole for the male camlock.

3

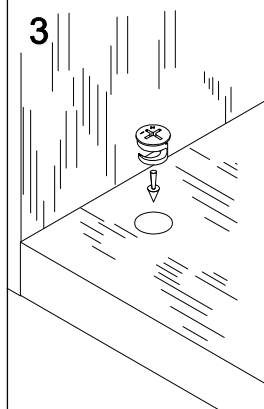

Step 4

Turn the female camlock clockwise with a screwdriver.

You should feel a click when the camlock is locked in place.

The joint is now secure.

4

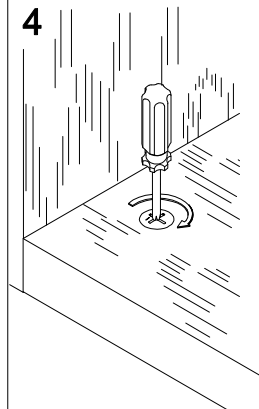



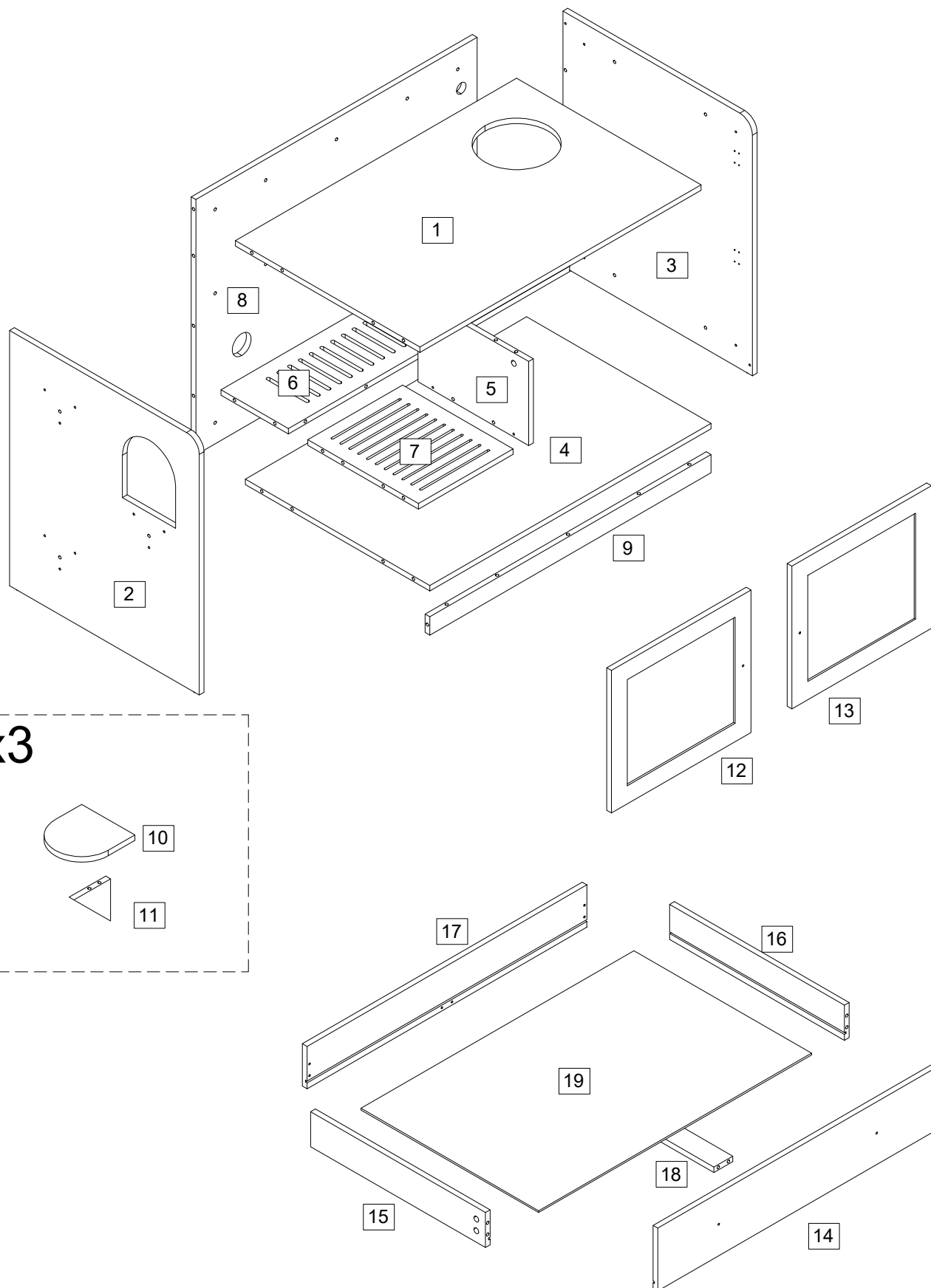



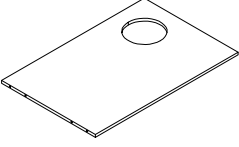
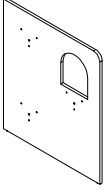
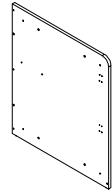
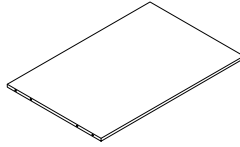

Assembly Instructions

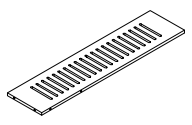

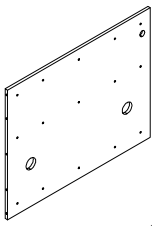
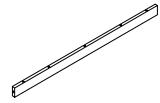

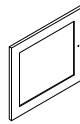
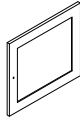
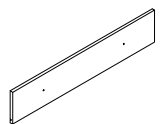
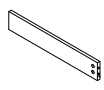

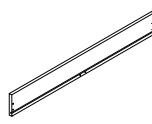
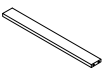
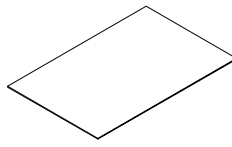



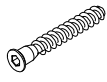

Part List

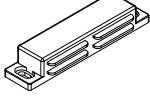
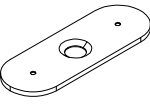
Hardware list

 <p>1 pc</p>	 <p>1 pc</p>	 <p>1 pc</p>	 <p>1 pc</p>	 <p>1 pc</p>
 <p>1 pc</p>	 <p>1 pc</p>	 <p>1 pc</p>	 <p>1 pc</p>	 <p>3 pcs</p>
 <p>3 pcs</p>	 <p>1 pc</p>	 <p>1 pc</p>	 <p>1 pc</p>	 <p>1 pc</p>
 <p>1 pc</p>	 <p>1 pc</p>	 <p>1 pc</p>	 <p>1 pc</p>	

Hardware list

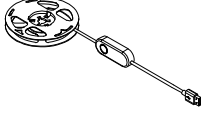
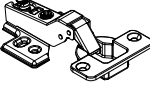
<p>A </p> <p>Male Camlock x 47</p>	<p>B </p> <p>Female Camlock x 47</p>	<p>C </p> <p>Dowel x 34</p>
<p>D </p> <p>7*38mm Screw x 9</p>	<p>E </p> <p>3.5*14mm Screw x 34</p>	<p>F </p> <p>x 1</p>
<p>G </p> <p>x 2</p>	<p>H </p> <p>x 6</p>	<p>I </p> <p>Handle x 4</p>
<p>J </p> <p>4*18mm Screw x 4</p>	<p>K </p> <p>4*35mm Screw x 6</p>	<p>L </p> <p>Hex Key M4 x 1</p>
<p>M </p> <p>x1</p>	<p>N </p> <p>x4</p>	

Assembly Tools Required (Not Included)

Assembly Instructions

Step 1

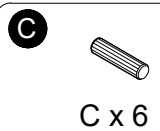
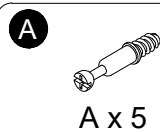
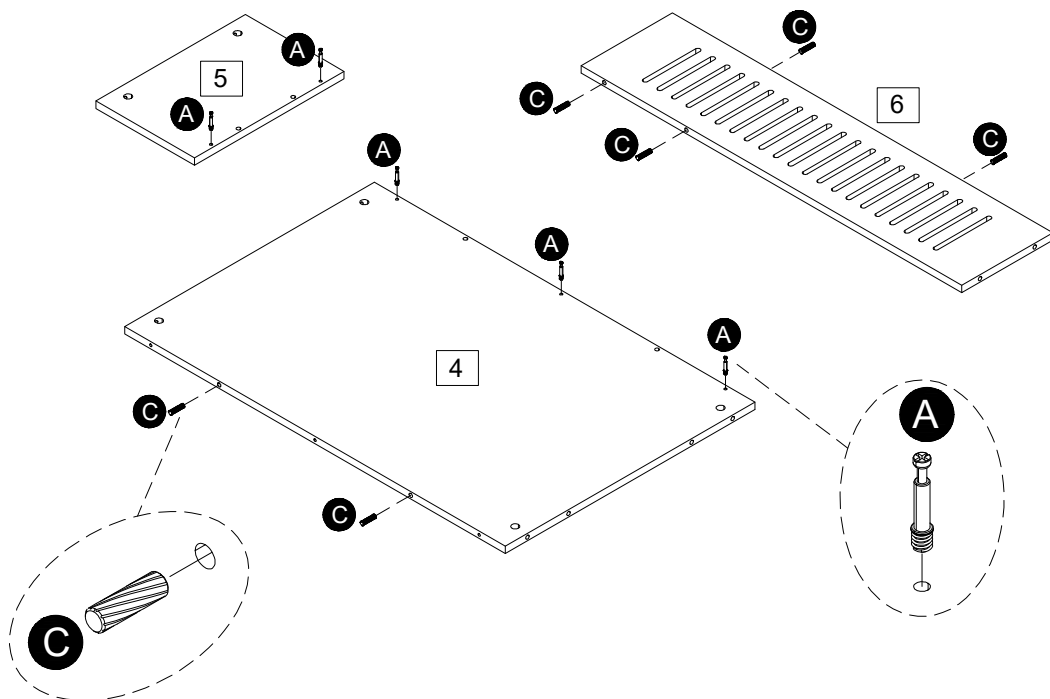

Step 2

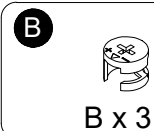
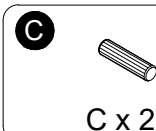
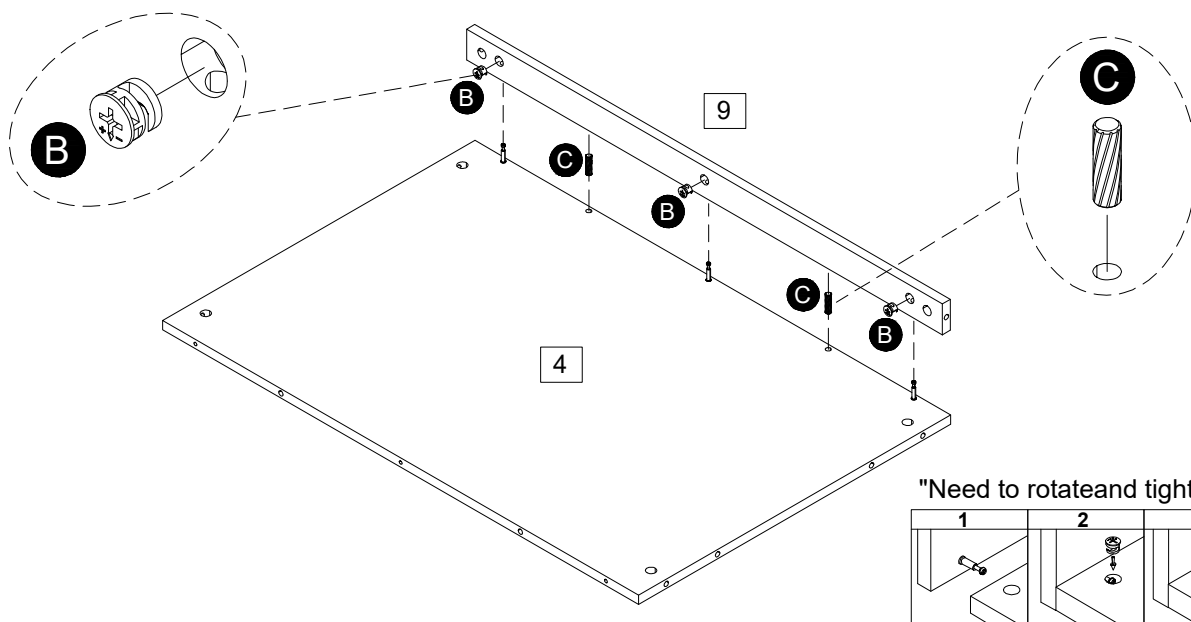

Assembly Instructions

Step 3

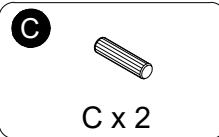
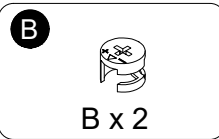
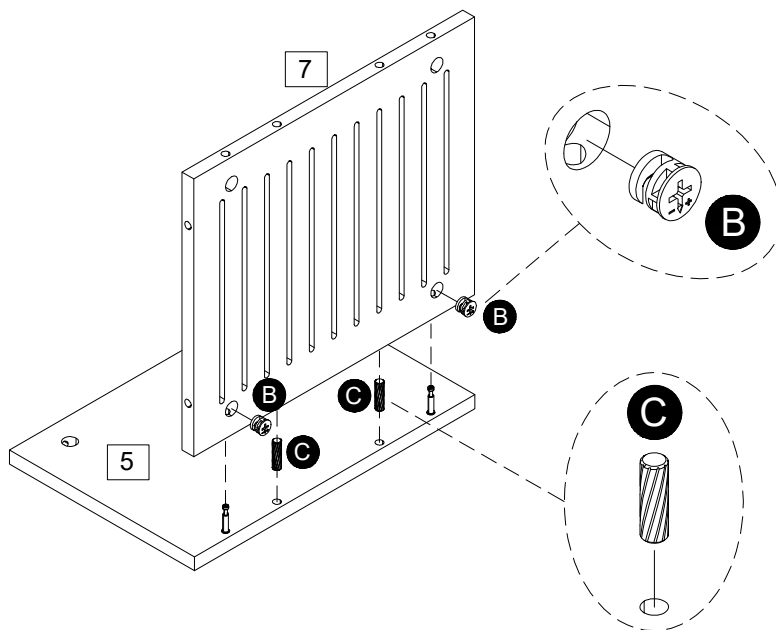

"Need to rotate and tighten B"

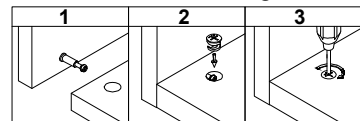

Step 4

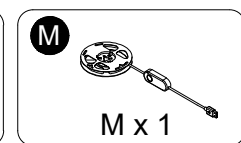
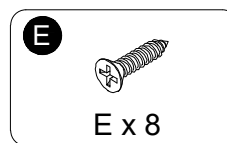
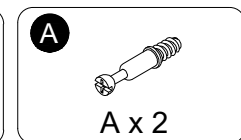
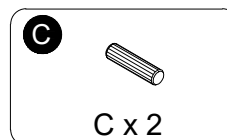
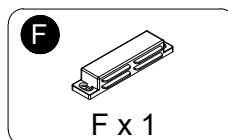
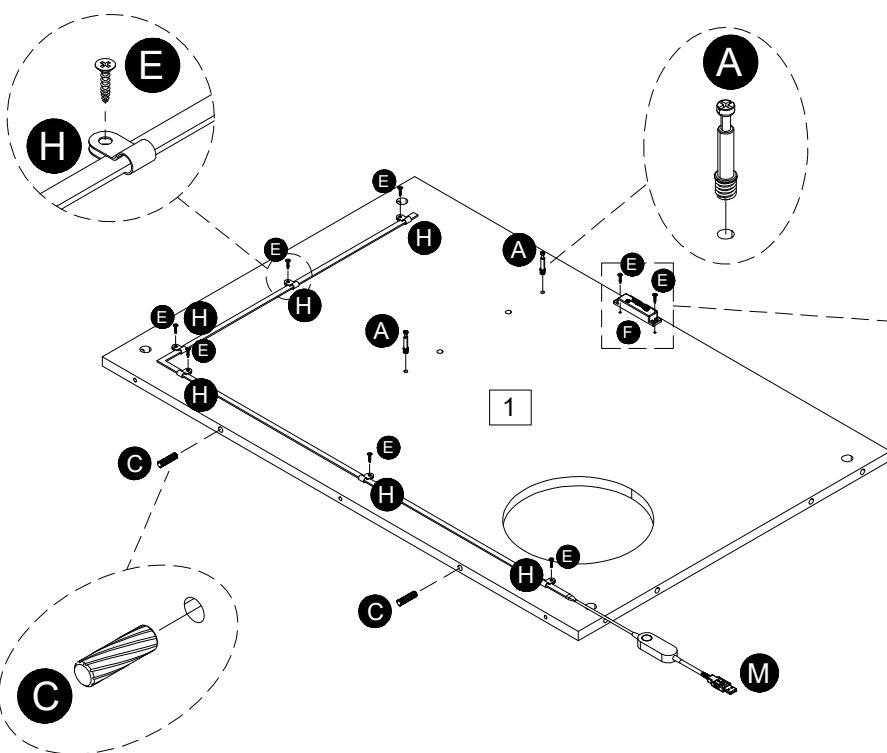

Assembly Instructions

Step 5

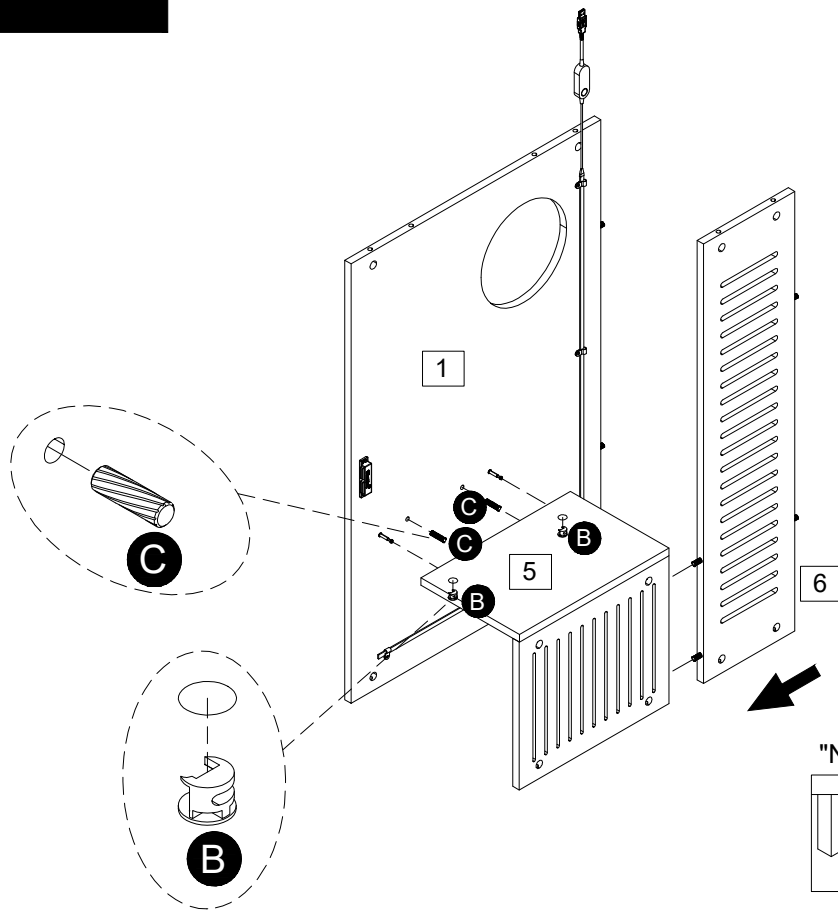

Step 6

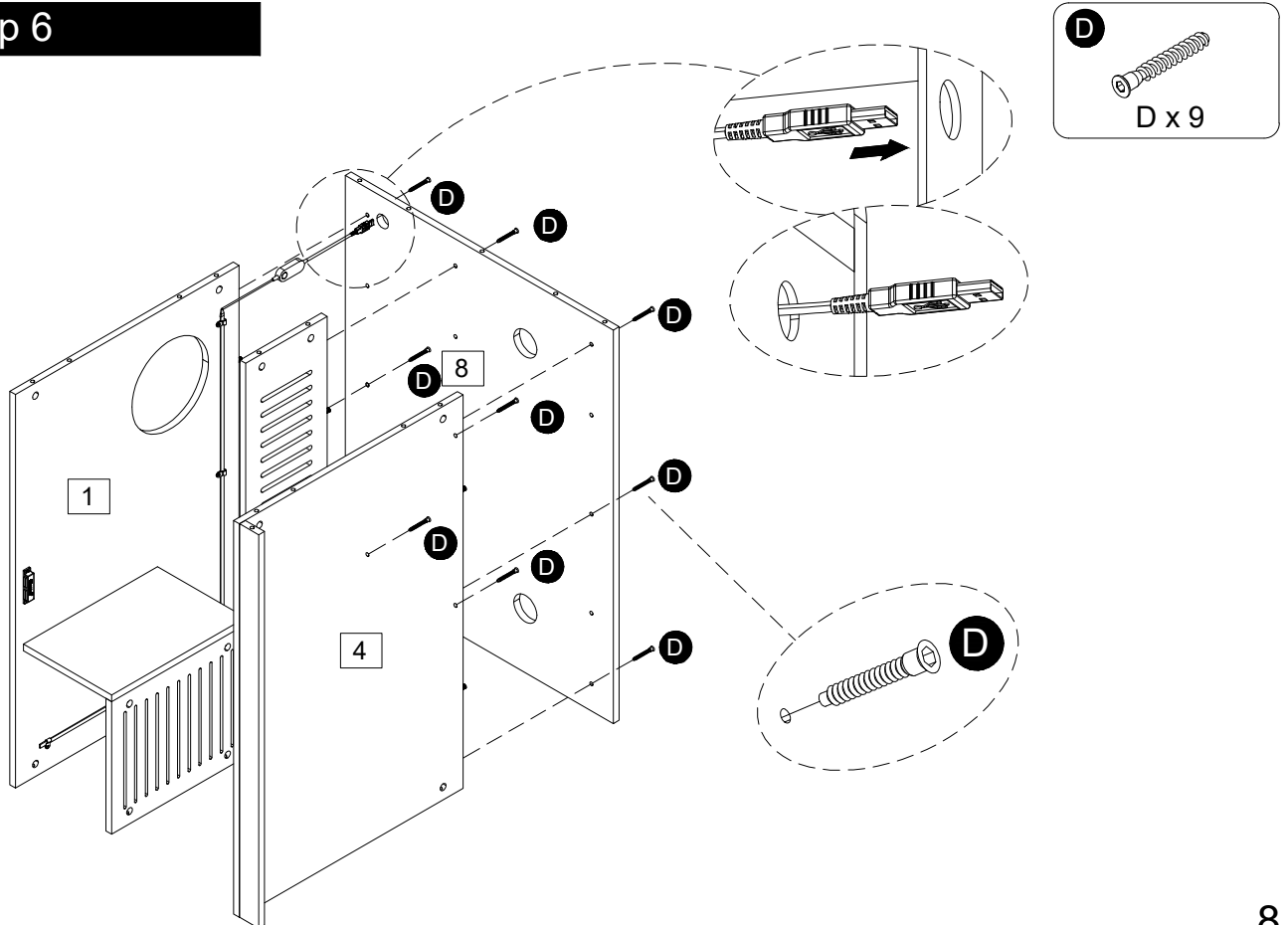

Assembly Instructions

Step 7

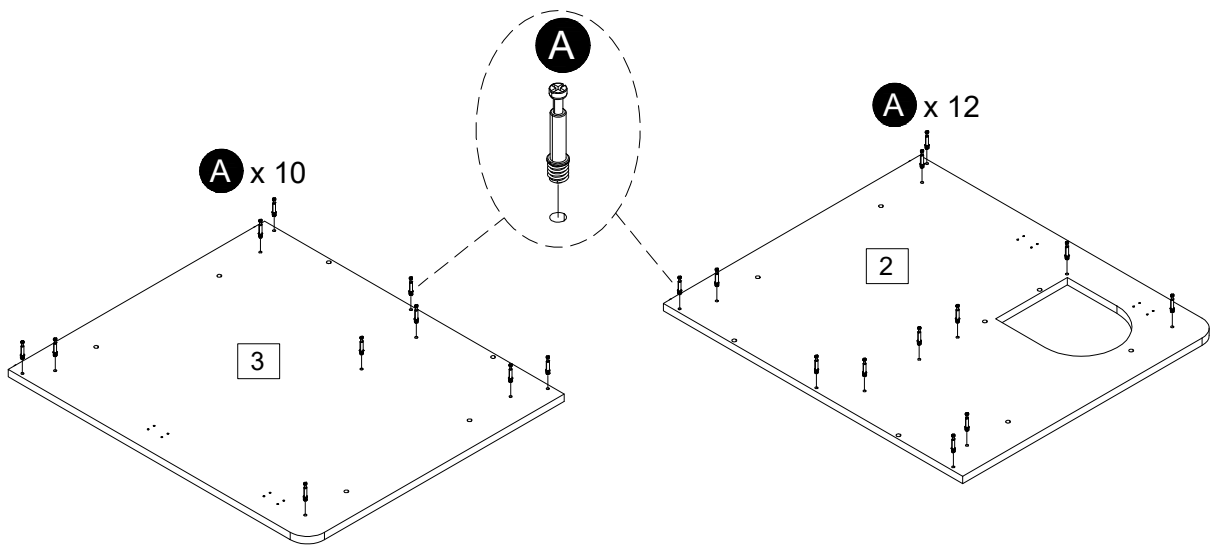
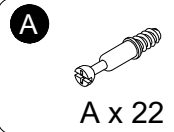

Step 8

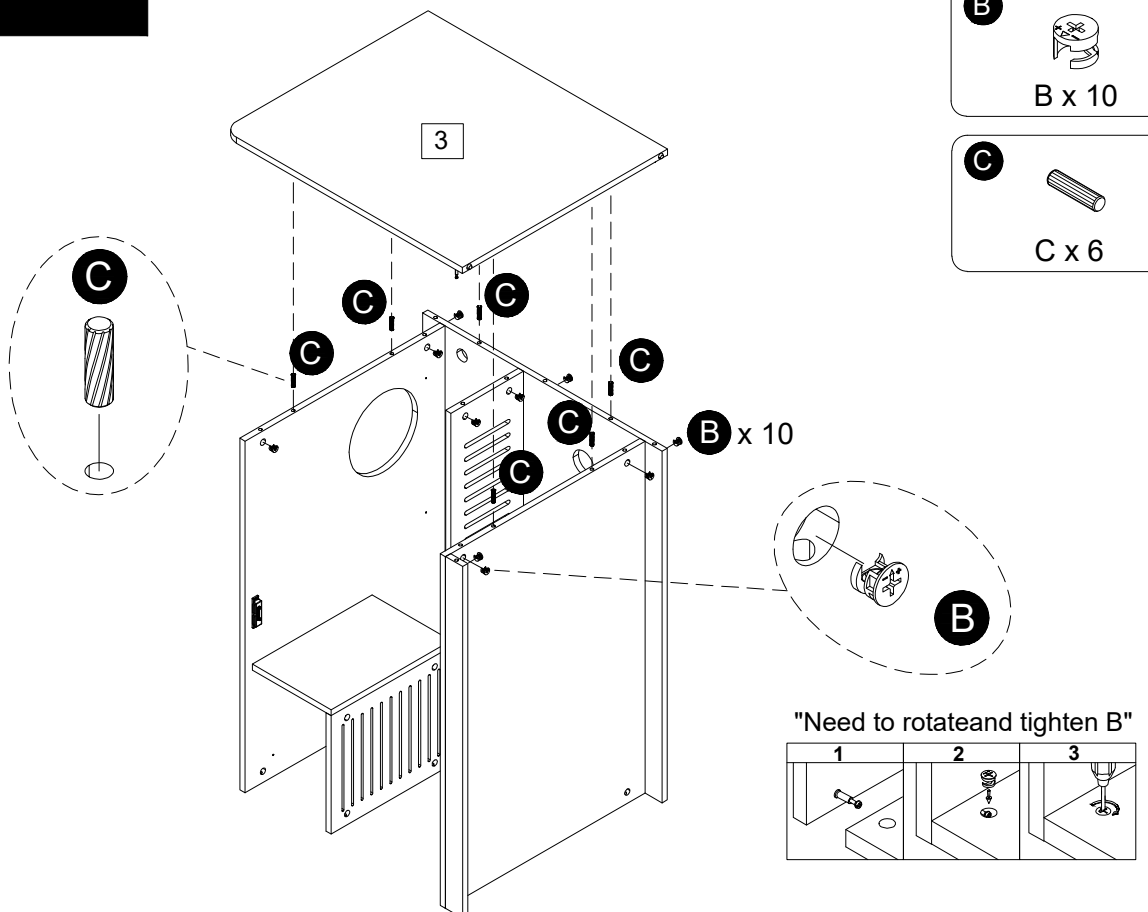
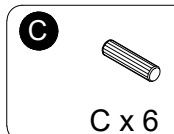
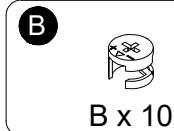

Assembly Instructions

Step 9

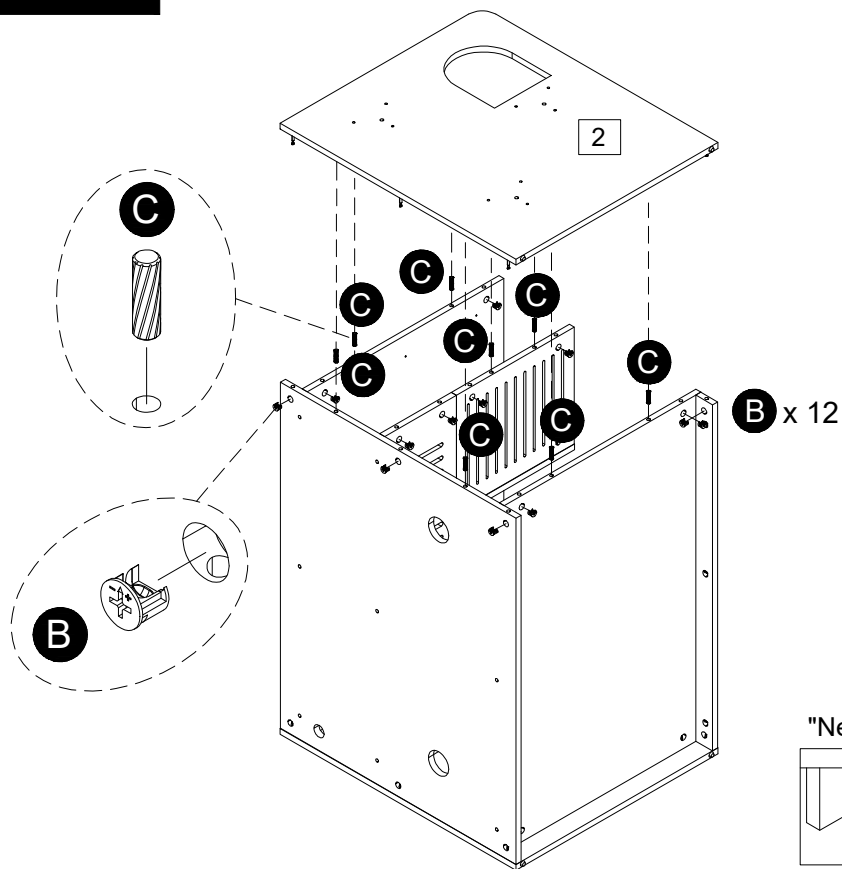

Step 10

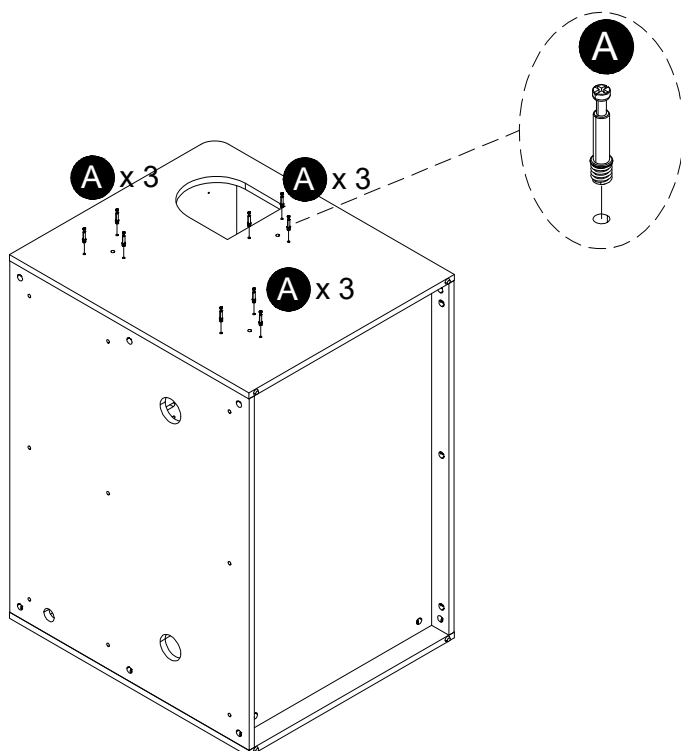

Assembly Instructions

Step 11

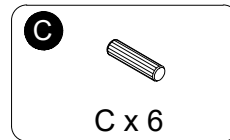
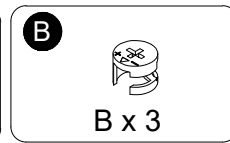
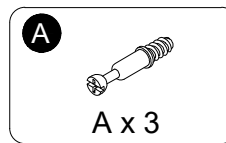

"Need to rotate and tighten B"

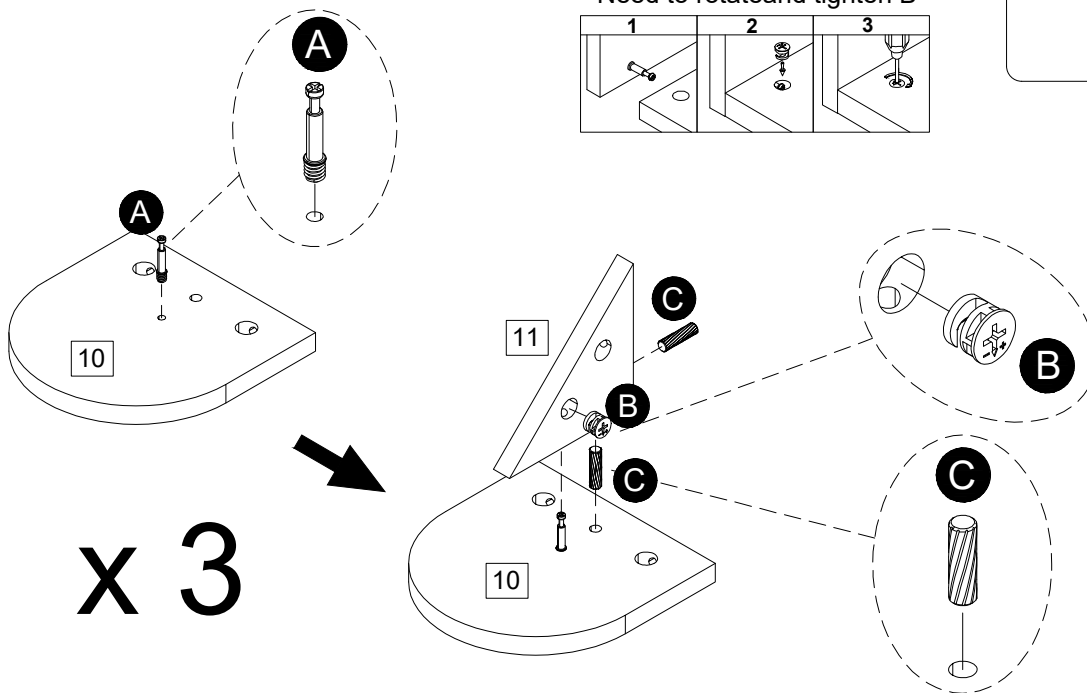
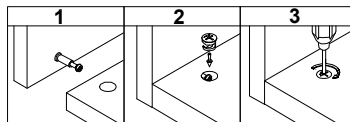

Step 12

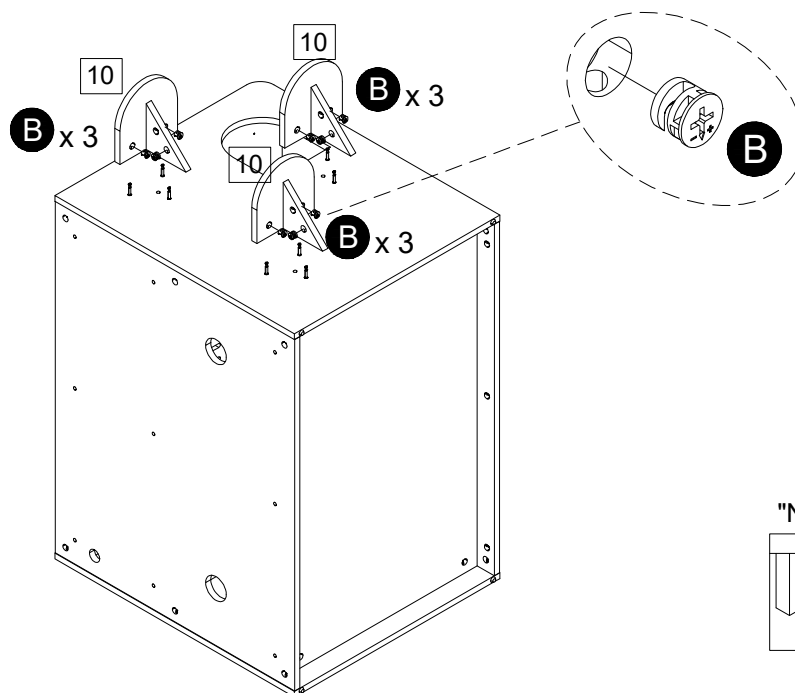

Assembly Instructions

Step 13

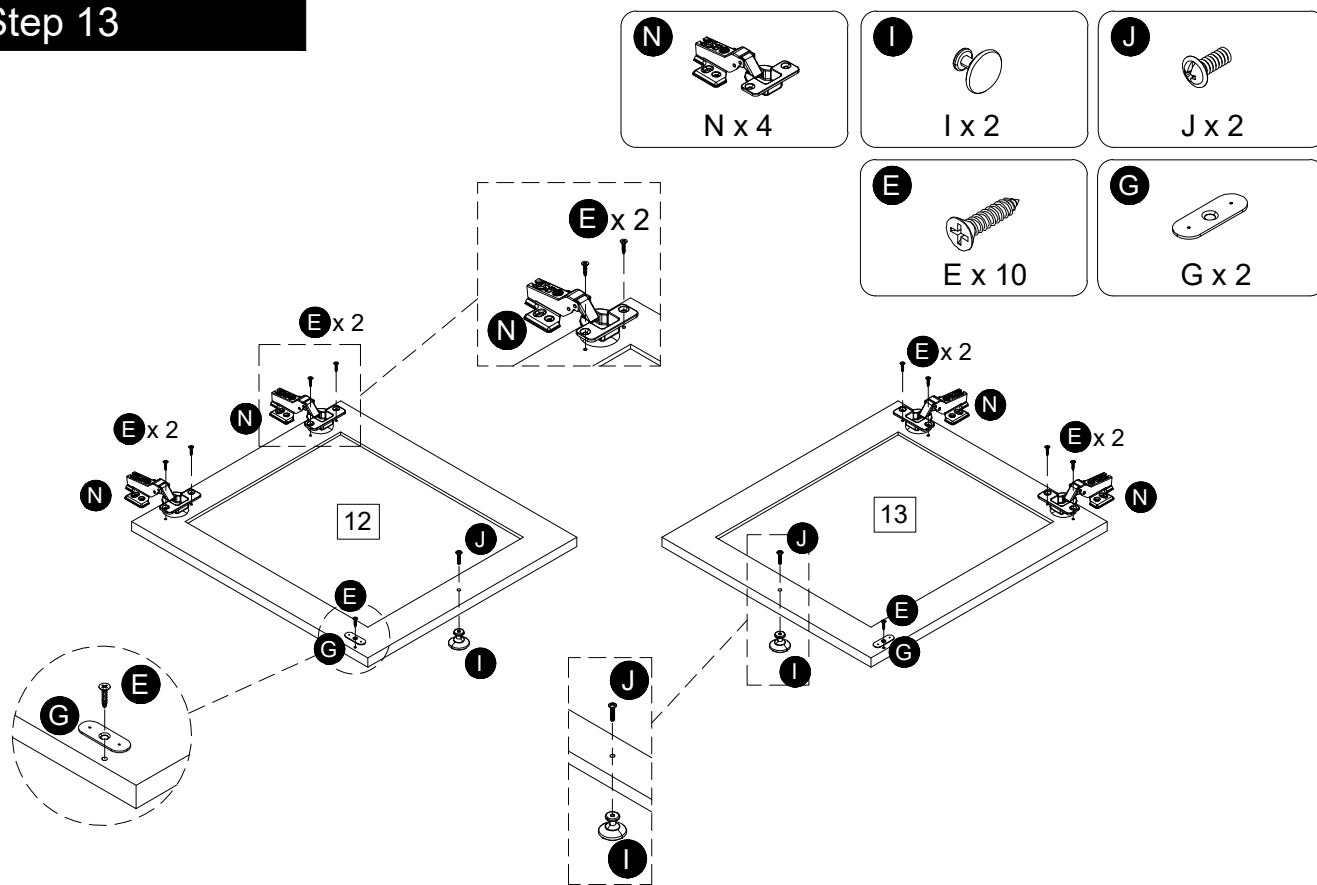

Step 14

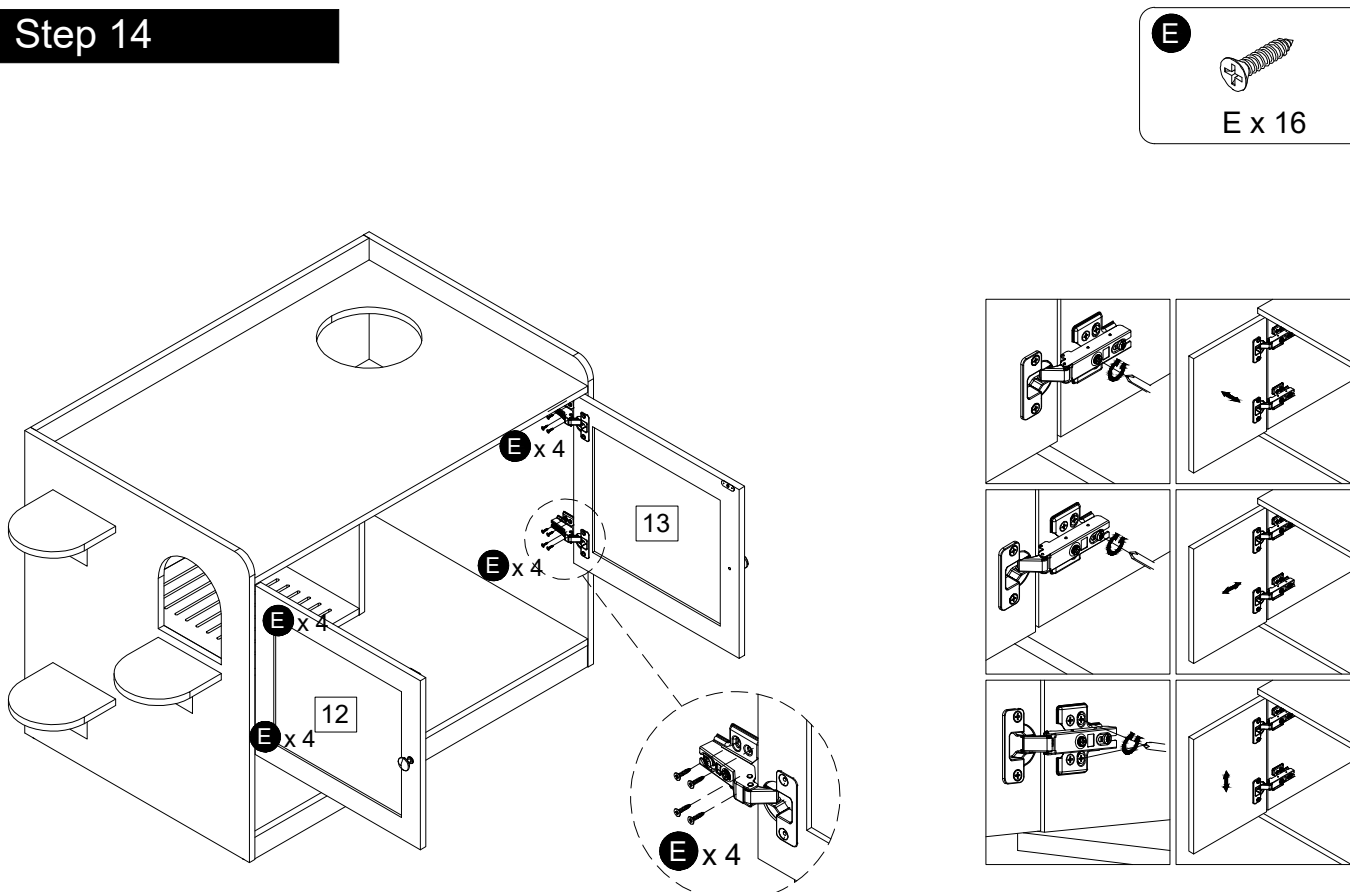

Assembly Instructions

Step 15

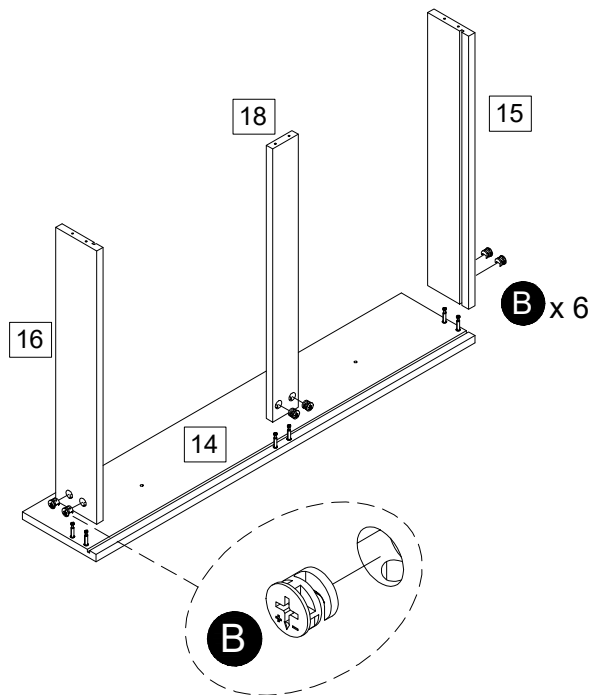
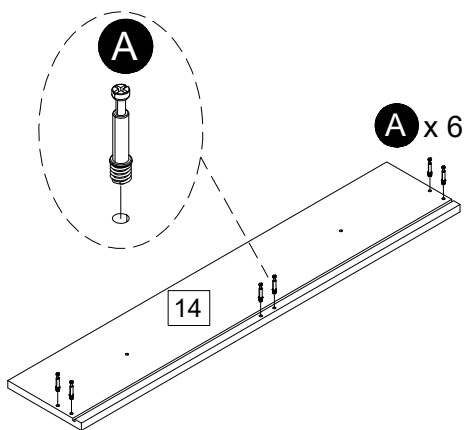
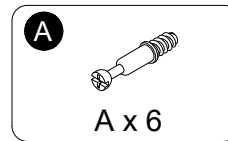

"Need to rotate and tighten B"

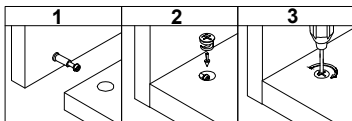

Step 16

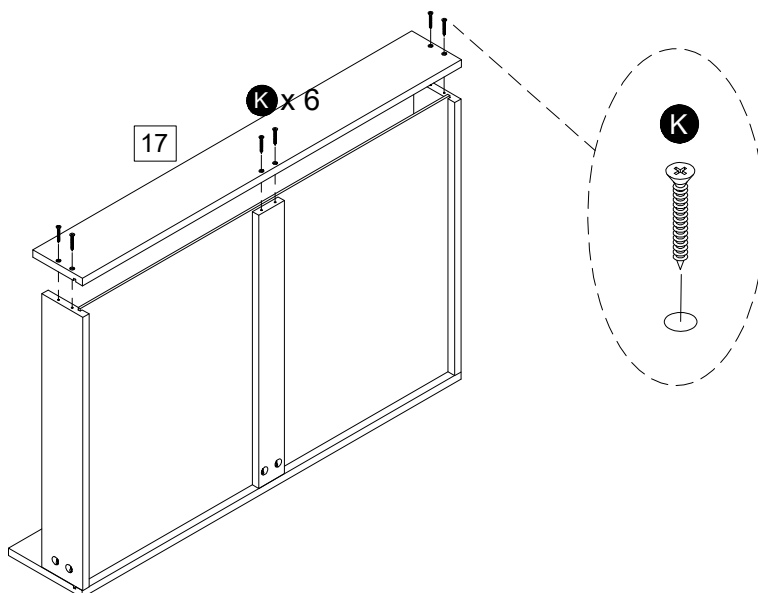
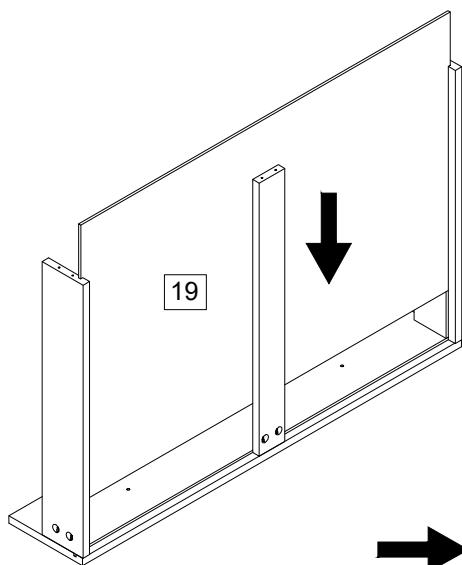
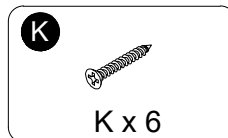

Assembly Instructions

Step 17

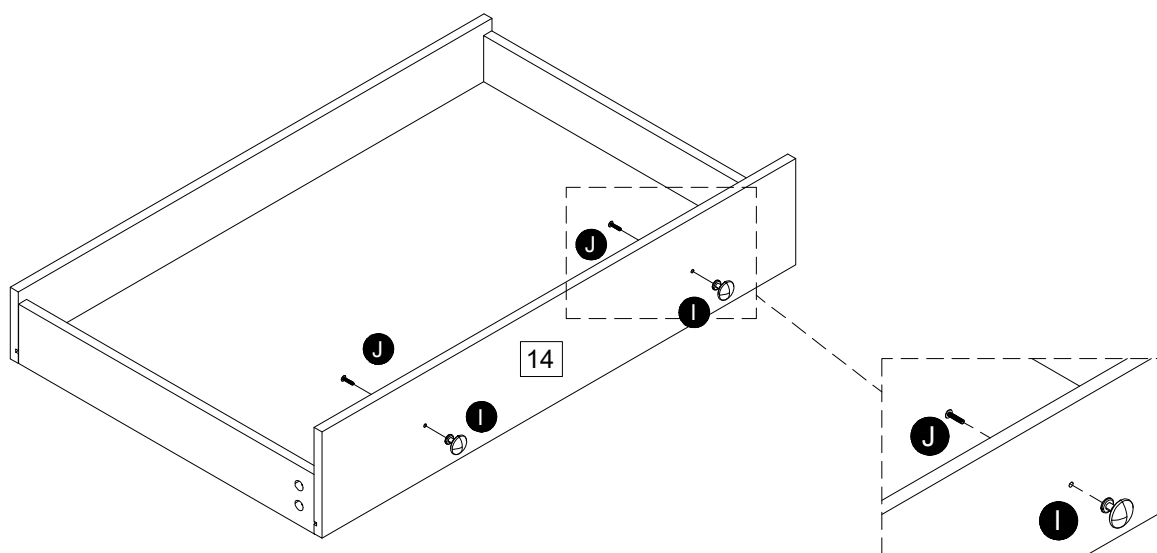
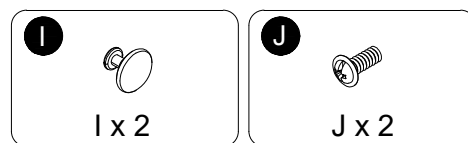

Step 18

