

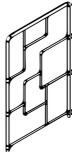

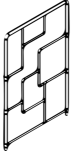

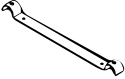

ASSEMBLY INSTRUCTION





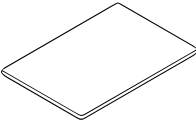
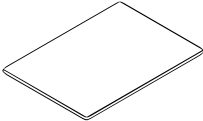

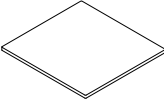
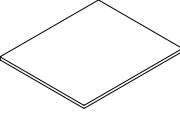
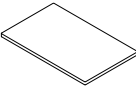

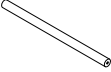
Book Shelf

Thank you for purchasing this quality product. Be sure to check all packing materials carefully for small parts which may have come loose inside the carton during shipment. Separate, identify, and count all parts and metal hardware. Compare with parts list to be sure all parts are present. If any part(s) are missing or damaged, please contact your local furniture dealer. For efficient and speedy service, please indicate the model number and code letter of the part(s) needed.

***** Do not fully tighten screws until fully assembled *****

COMPONENT PARTS		
DECERPTION	PART NAME	Q'TY(PCS)
①	Front Frame 	1pc
②	Rear Frame 	1pc
③	Top Side Hooks 	2pcs
④	Lower Hooks 	18pcs
⑤	Top Middle Hook 	1pc
⑥	Right Side Tube (Long) 	1pc
⑦	Left Side Tube (Short) 	1pc
⑧	Top Shelf 	2pcs
⑨	Bottom Shelf 	2pcs

⑩	Middle Shelf		2pcs
⑪	Big Shelf		2pcs
⑫	Small Shelf		3pcs
⑬	Adjustable Foot		4pcs
⑭	Side Lower Tube		2pcs

HARDWARE REQUIRED:	
①	 Bolt 1/4"x5/8" - 6pcs
②	 Bolt 1/4"x3" - 8pcs
③	 Screw M5x12 - 44pcs
④	 Allen Wrench M4 - 1pc
⑤	 Screw M4x37 - 1pc
⑥	 Metal Plate - 2pcs
⑦	 Bracket - 1pc
⑧	 Girding - 1pc

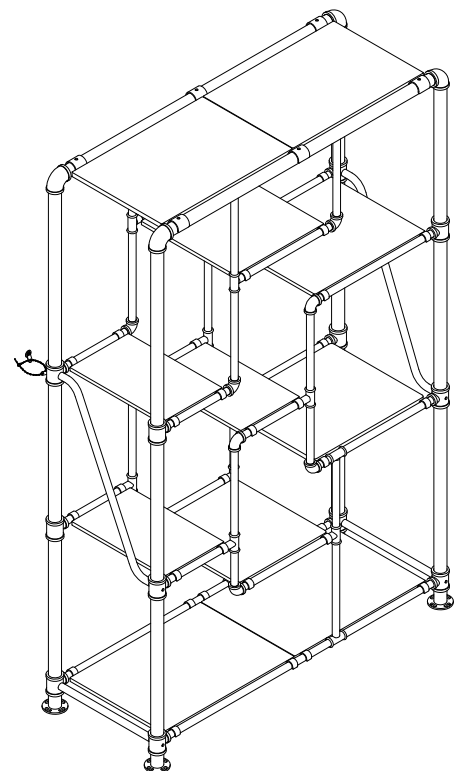

Attention:

***Mattresses not included.

***Some number parts listed on the instruction sheet may not be in parts bag as they may already be assemble. Carefully check parts and packing materials prior to ordering replacements.

How to Assemble:

STEP 1.

Exploded View

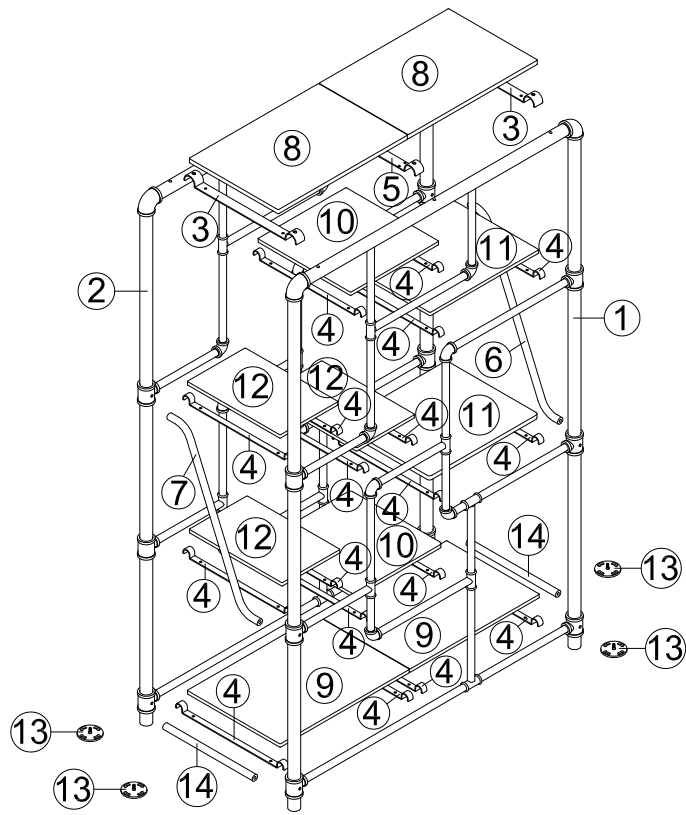

STEP 2.

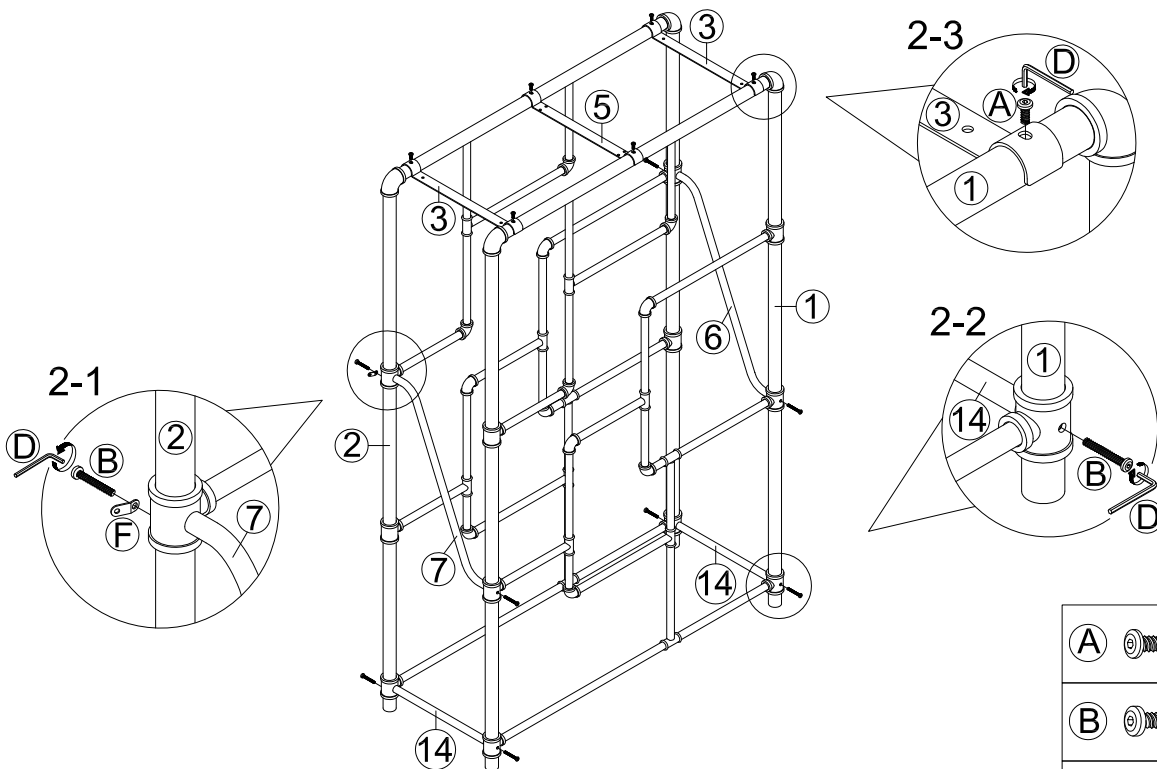

(A)		6pcs
(B)		8pcs
(F)		1pc

How to Assemble:

STEP 3.

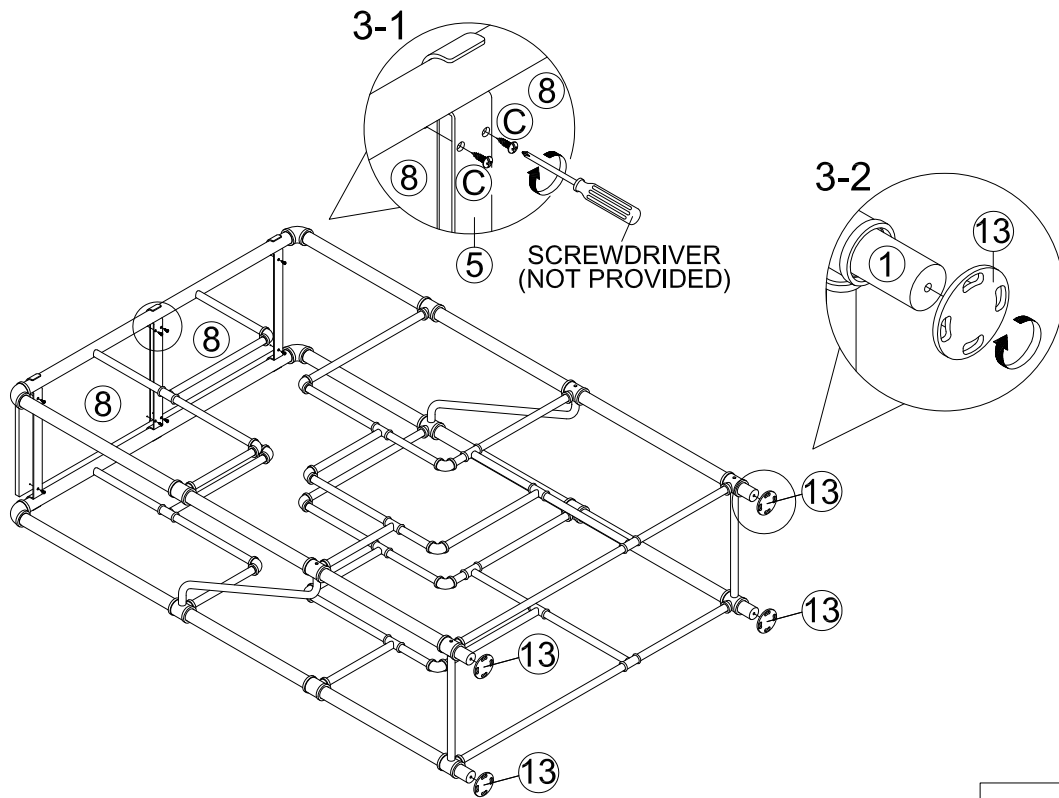

Ⓒ  8pcs

STEP 4.

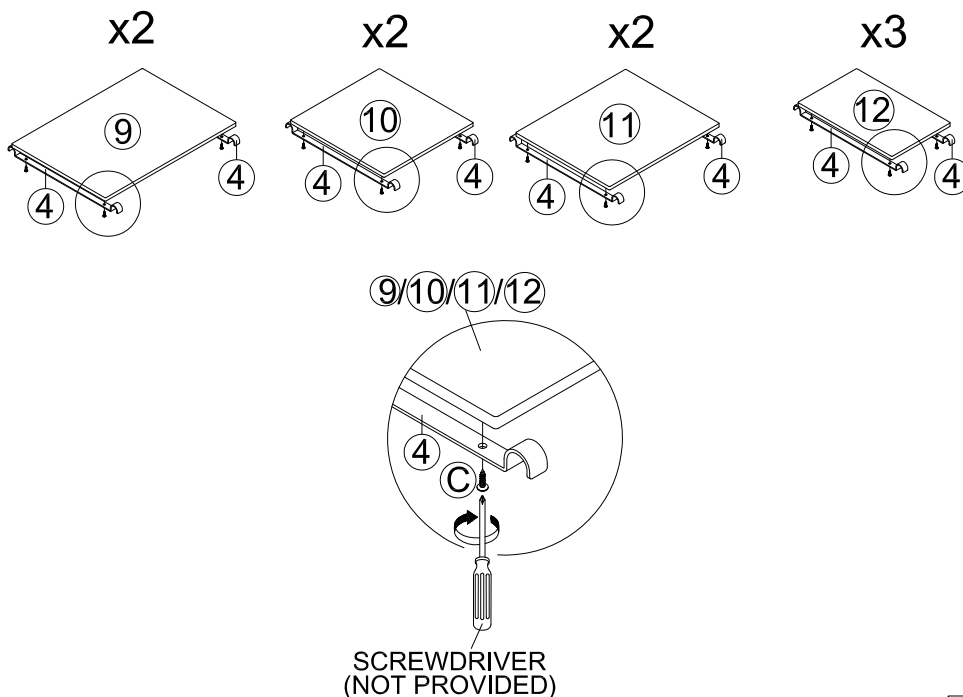

Ⓒ  36pcs

How to Assemble:

STEP 5.

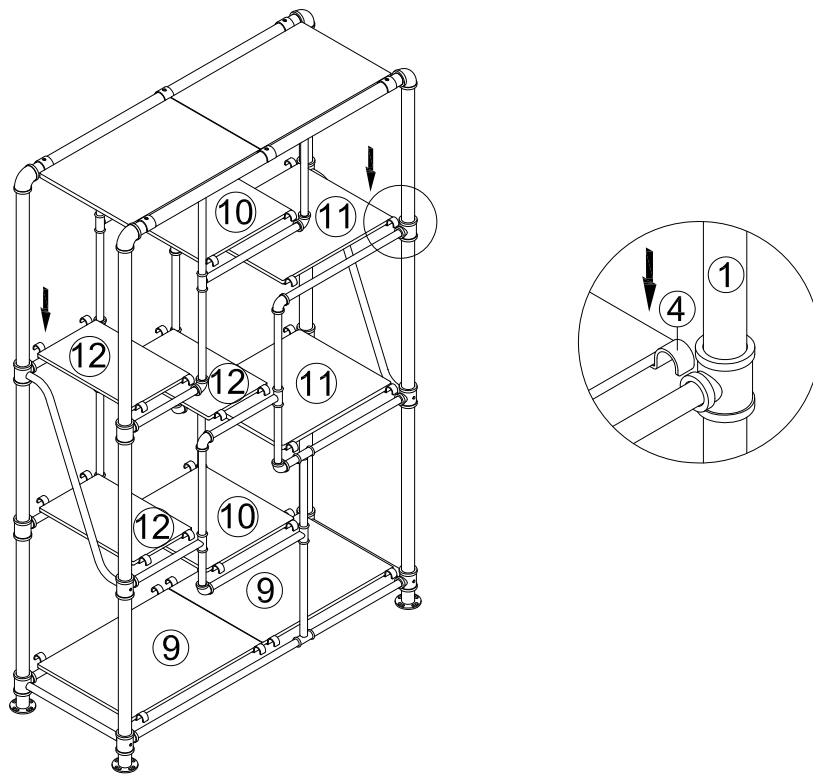

STEP 6.

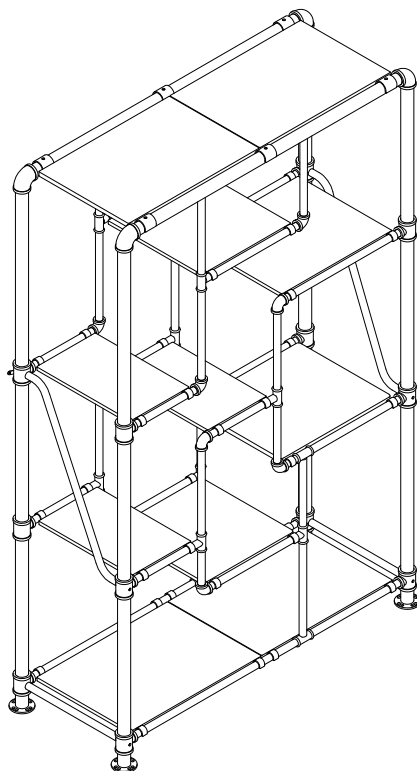

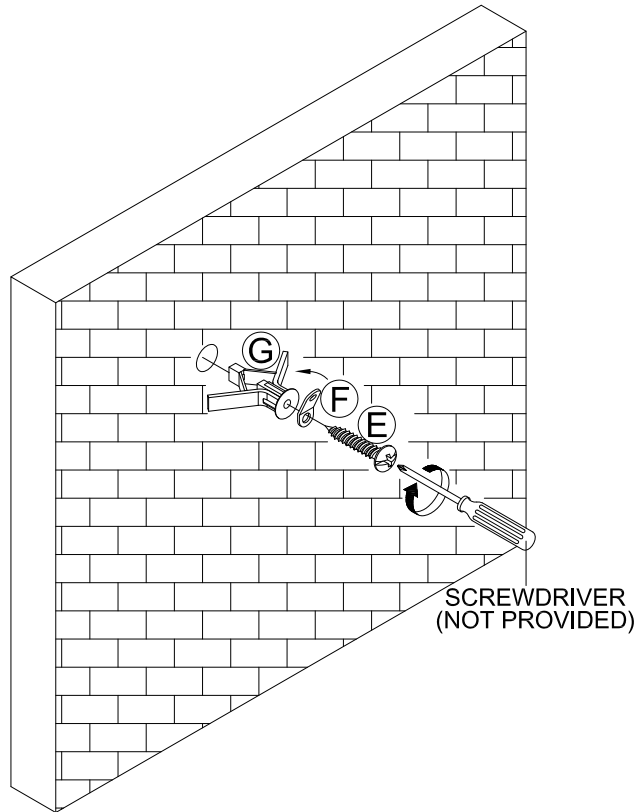

How to Assemble:

STEP 7.



SCREWDRIVER
(NOT PROVIDED)

(E)		1pc
(F)		1pc
(G)		1pc

STEP 8.

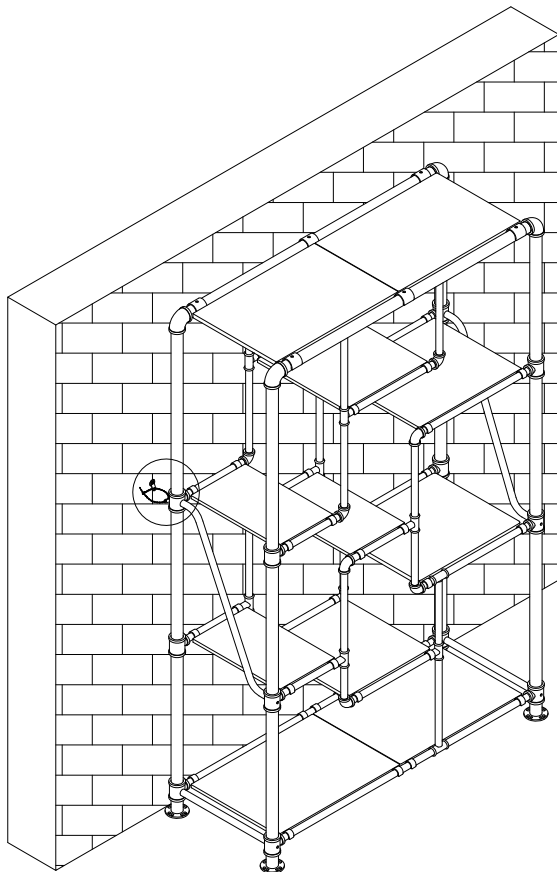

To Prevent Tip over
Product Must Be
Attached To Wall

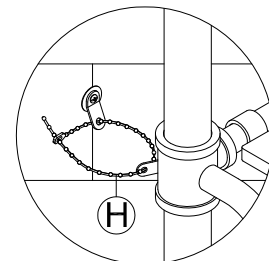

(H)		1pc
-----	---	-----