

ASSEMBLY INSTRUCTIONS

CHEST

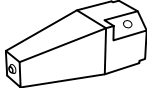

(Box 1)
BOX OF CHEST

No	ITEM	Qty
A	CHEST 	1 pc
B	BUN FOOT 	4 pcs

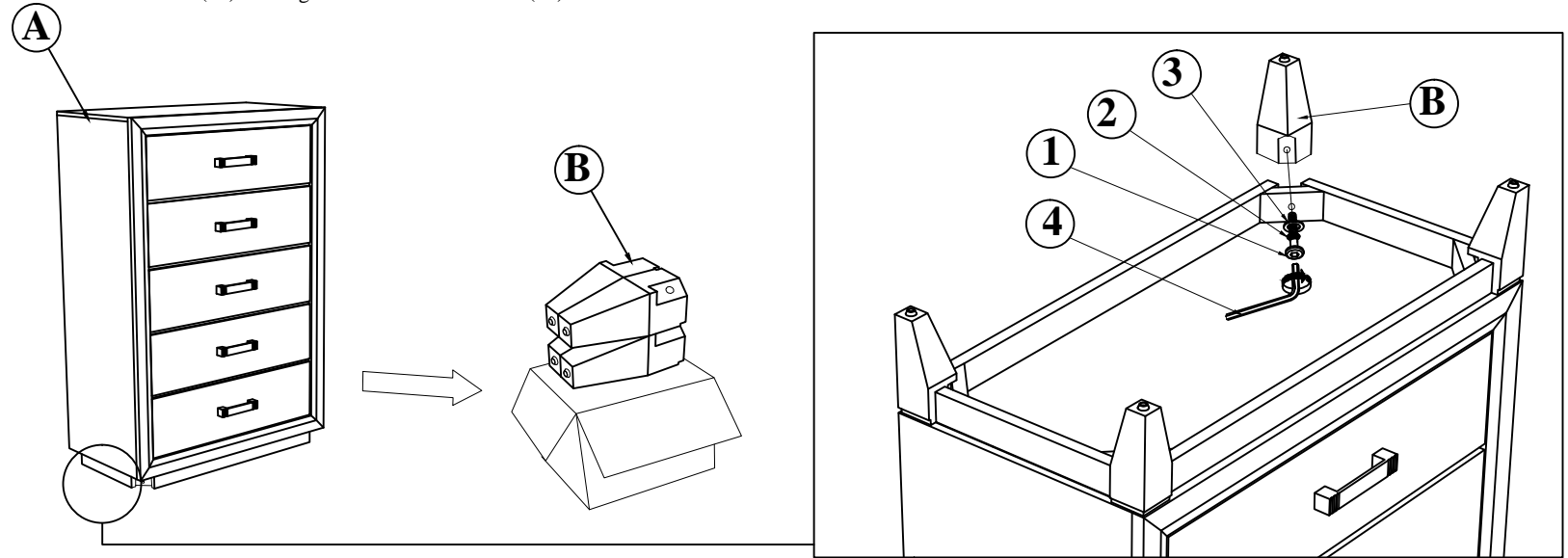
STEP 1 : Pull the top drawer and take out the Bunfoot carton (B). Attach the Bunfoot (B) at the bottom Chest (A) used JCBC (1) with Spring Washer (2) Flat Washer (3) and Tighten with Allen Wrench (4).

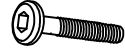

(Box 1)
HARDWARE LIST

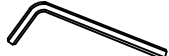
No	ITEM	Qty
1	JCBC M8 x 50mm 	4 pcs
2	SPRING WASHER 5/16" Rbw 	4 pcs
3	Flat Washer 5/16" ID x 22mm OD Blk 	4 pcs
4	ALLEN KEY m5x65mm Blk 	1 pc



COMPLETED ASSEMBLY

NOTE : MUST TIGHTEN SCREWS **PERIODICALLY** WITH USE SCREW WILL BECOME LOOSE CHECK TIGHTNESS OF ALL SCREW EVERY 6-8 WEEKS.