

ASSEMBLY INSTRUCTIONS

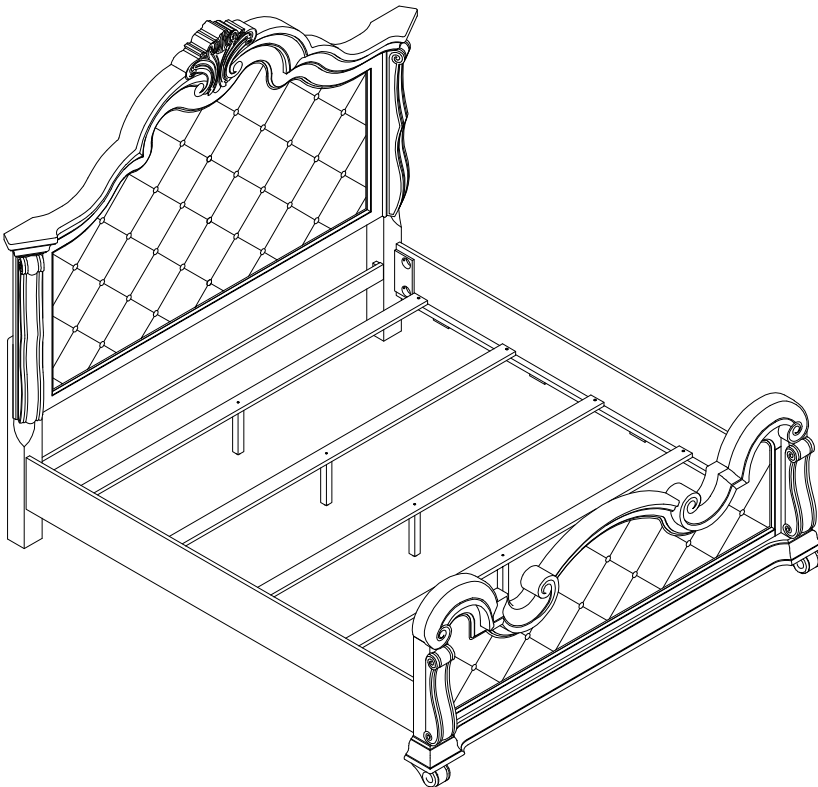

TOOLS REQUIRED



(Included)
Allen Wrench-M4



(Not Included)
Phillips Screwdriver



2-People

Enjoying this product? We'd love your 5-star review!

If you have any issues, our support team is happy to help .

Thank you for your purchase!

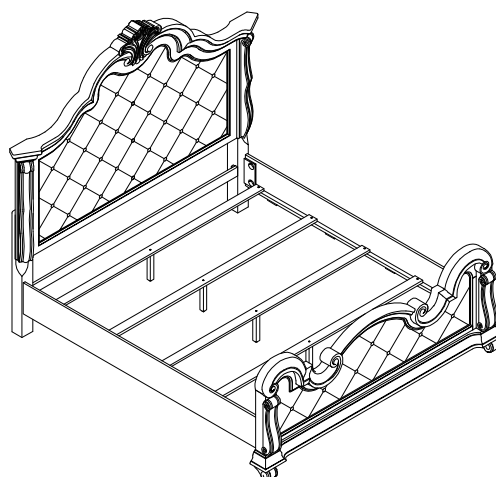

CHECK BEFORE STARTING

Are you missing anything?

Please double check all hardware and parts match the assembly guide before putting the product together. If damaged, we suggest you put the item back in the box and start your claim or return.

Should we send any replacements?

If there are any manufacturer defects or missing pieces please contact us for replacements. If purchased online, please contact the website of where you purchased it from, DIRECTLY.

IMPORTANT INFO before assembly:

- If there's a problem with the parts do not attempt to assemble the product
- Place all parts on a clean and smooth surface such as a rug/carpet to avoid parts from being scratched
- When tightening screws to product do not overtighten until product is fully setup
- If product is too heavy for a single person to carry do not attempt and ask for assistance
- DO NOT DRAG or PUSH item to desired location. Must be carried when moving
- If item is not working as intended please review the assembly guide to see if any steps were missed or incorrectly built. If there's a problem with part please contact seller for additional assistance.
- Please keep all hardware and small parts away from pets/infants
- Please wear gloves or protective gear to protect from getting cuts
- It is normal for new furniture to have an off gassing smell. Please air out furniture near a window for a few hours or a day before placing it in desired location
- All products may have a slight color and texture variation due to different shipments, natural materials, screen-resolutions, or lighting in home, images are rendered by different devices or websites

- Please keep instructions for future reference
- Check the quantity and irregularity of parts and hardware before you start
- If assembly guide is misplaced, please visit our website for copy

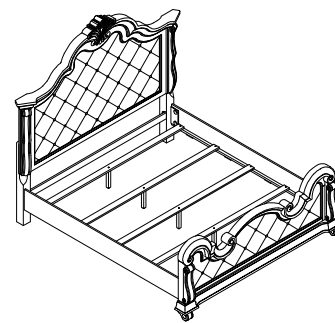

Queen Bed

Part List

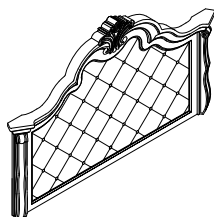

A.Headboard Panel-1pc

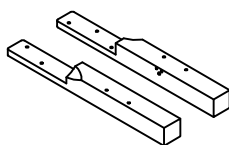

B.Headboard Leg(L&R)-2pcs

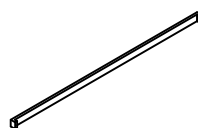

C.Headboard Cross Bar -1pc

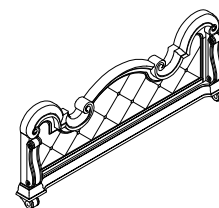

D.Footboard-1pc

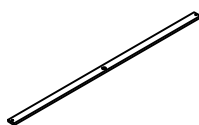

E.Slats-4pcs

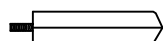

F. Support Leg For Center Slat-4pcs

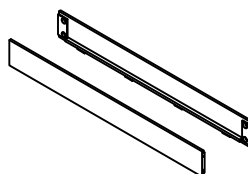

G.Side Rails-2pcs

Hardware List

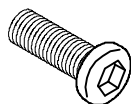

1.Allen Bolt-M8*45
8pcs



2.Spring Washer-M8
16pcs



3.Flat Washer-M8
8pcs

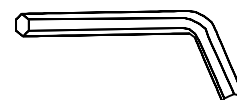

4.Allen Wrench- M4
1pc

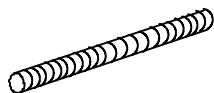

5. Bolt-M8*88
8pcs

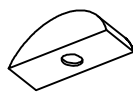

6.Curved Washer-M8
8pcs



7.Nut-M8
8pcs

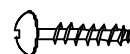

8.Screw-8#*32
8pcs

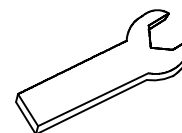

9.Wrench- M8
1pc

If any parts/hardware listed are damaged or missing
Please contact the seller for additional assistance

ASSEMBLY INSTRUCTION

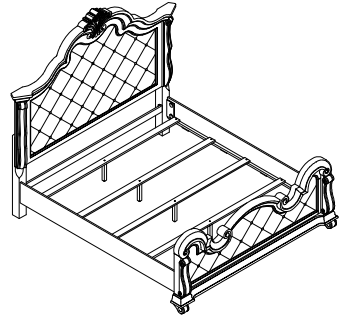

IMPORTANT

Please keep Allen Key in a safe place as you may need to tighten up the Bolts in the future.
Use a soft cloth between these parts and the floor.
After assembly, item must be level to work properly. Use the included adjustable levelers to level.

Step 1

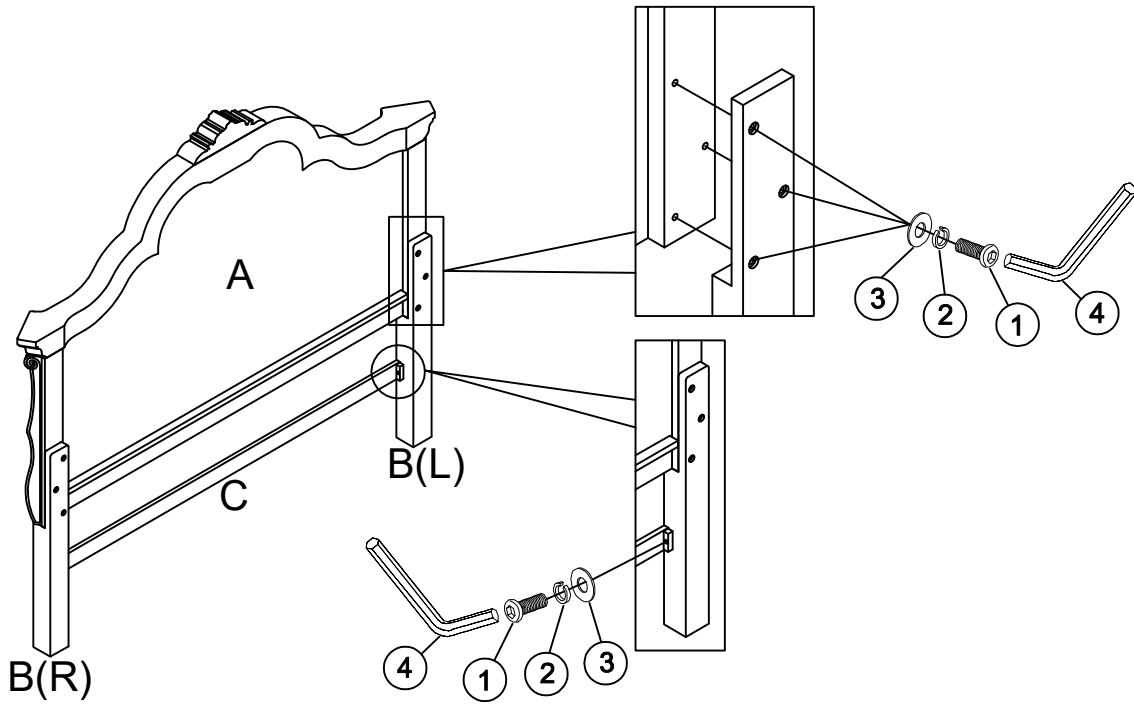

Step 2

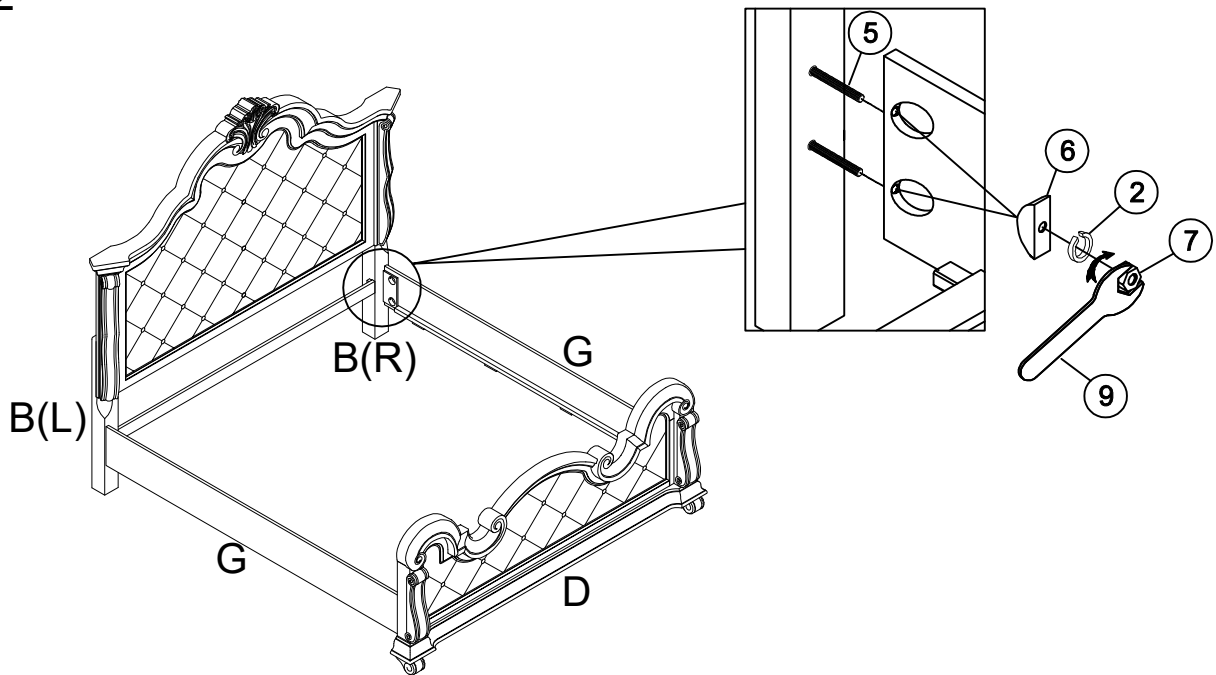

ASSEMBLY INSTRUCTION

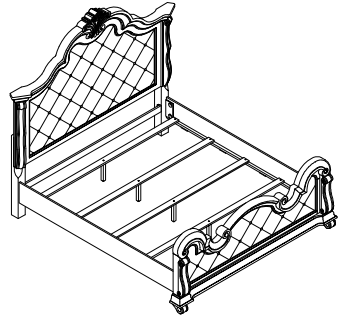

IMPORTANT

Please keep Allen Key in a safe place as you may need to tighten up the Bolts in the future.
Use a soft cloth between these parts and the floor.
After assembly, item must be level to work properly. Use the included adjustable levelers to level.

Step 3

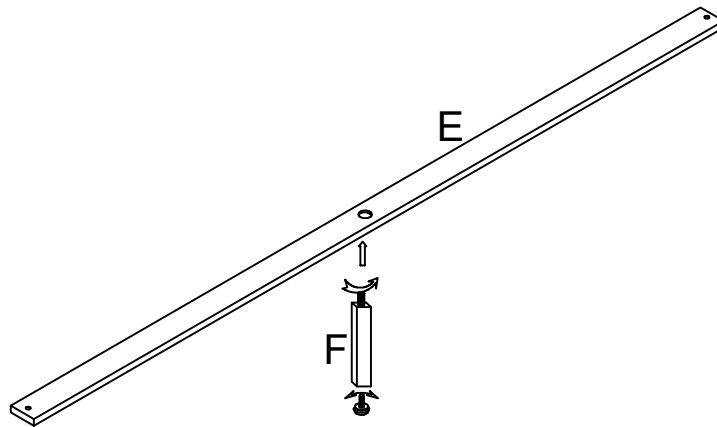

Step 4

