

Owner Manual

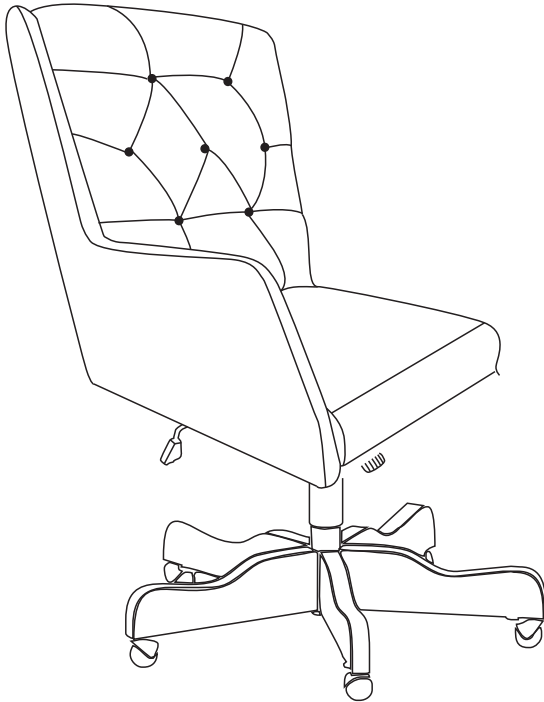

Installation:
15minutes.

One Person

Thank You For Choosing Our Furniture

- ▾ If you have any questions or concerns, don't hesitate to reach out to us. ▾

NOTE:







This brochure contains **IMPORTANT** safety info. Please read and keep it for future reference.

MAINTENANCE AND WARNING



Before You Start

Please follow the steps below:

-  Un box the package and check if all parts and accessories are complete.
-  Place the parts of the chair on a flat surface.
-  Ensure the chair is placed on a stable, flat surface to prevent it from tilting.
-  Avoid placing sharp or heavy objects directly on the chair to prevent tears or deformation.
-  Clean the installation area in advance and ensure the ground is level and there is enough space to avoid damaging the furniture or making installation difficult.
-  Lay a protective mat on the ground to prevent scratching the floor during installation.

After-Sales Service

- If you encounter any issues or need technical support during use, please contact our after-sales team. We offer long-term maintenance and warranty services.



Precautions

- ⚠ This product is for indoor use only. Do not expose it to outdoor elements or high-humidity environments.
- ⚠ Keep the product away from high heat or open flames to prevent fire hazards.
- ⚠ Do not allow children to climb on the product, as this may cause tipping and result in personal injury.



Safety Warnings

- ⚠ If you notice any loose or damaged parts, stop using the product immediately and contact customer service.
- ⚠ Do not attempt to disassemble or replace any components yourself, as this may affect the stability and safety of the product.



Daily Maintenance

- Regularly clean the surface with a soft cloth to prevent dust accumulation.
- Do not use cleaning agents containing acids, alkalis, or corrosive substances, as they may damage the surface. It is recommended to use neutral cleaning agents or specialized furniture cleaners.
- Avoid exposing furniture to humid environments for extended periods. Use a dehumidifier or desiccant during humid weather.
- Avoid direct contact of furniture with water. If water is accidentally spilled, wipe it dry immediately.
- Avoid placing excessively heavy objects on the furniture: ensure the weight is within a reasonable load-bearing range.
- Avoid using sharp or rough items on the furniture surface to prevent scratches. Handle items gently when moving them.

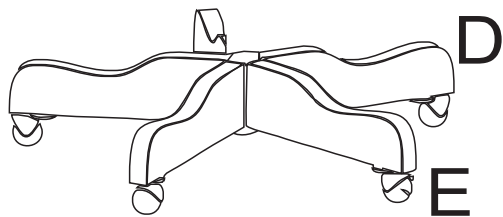
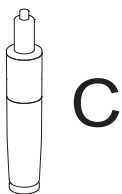
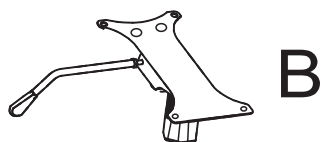
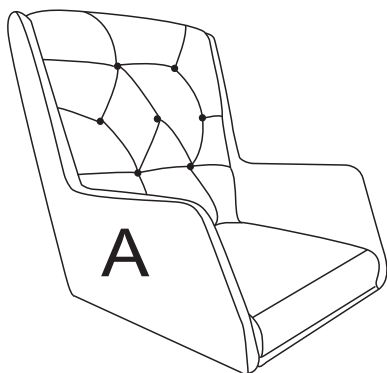
Explosive view



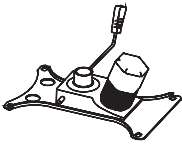

Parts List

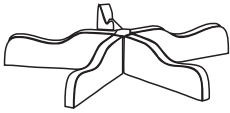
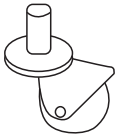
<p>A x1</p>  <p>Seat</p>	<p>B x1</p>  <p>Mechanism</p>	<p>C x1</p>  <p>Gas lift</p>
---	--	---

<p>D x1</p>  <p>Spider base</p>	<p>E x5</p>  <p>Casters</p>	
---	---	--

Hardware List

<p>① x (4+1)</p>  <p>Ø6x20mm</p>	<p>② x1</p>  <p>M6</p>	
---	---	--

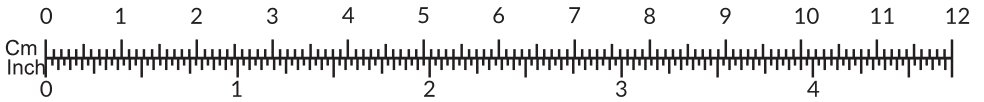

Note: Before installing the screws, please first distinguish the length of the screw rods.

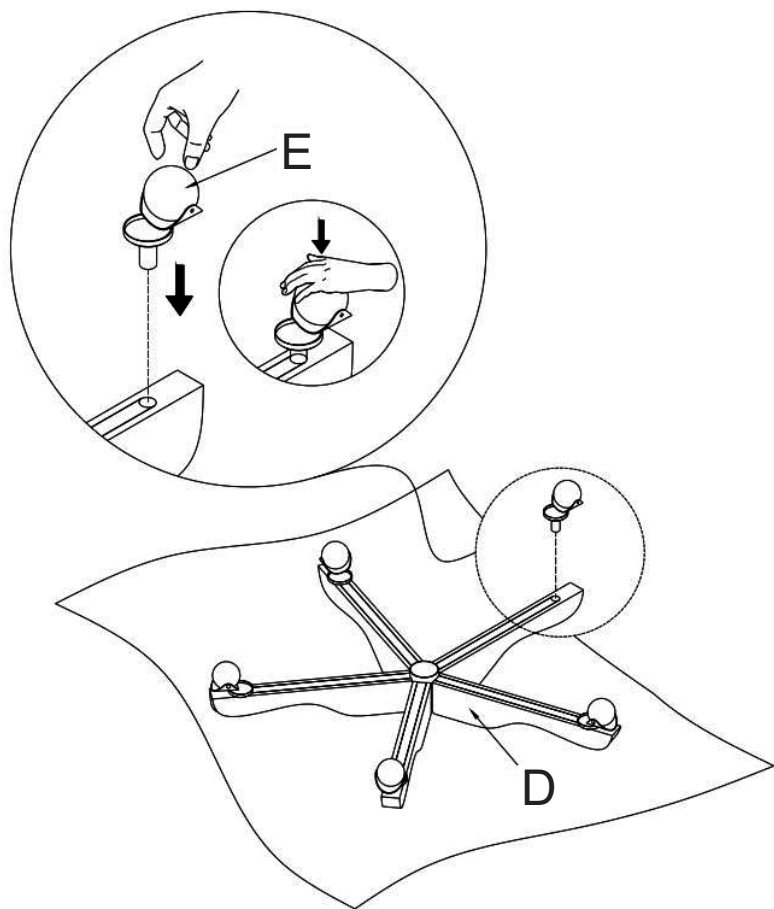

Step 1

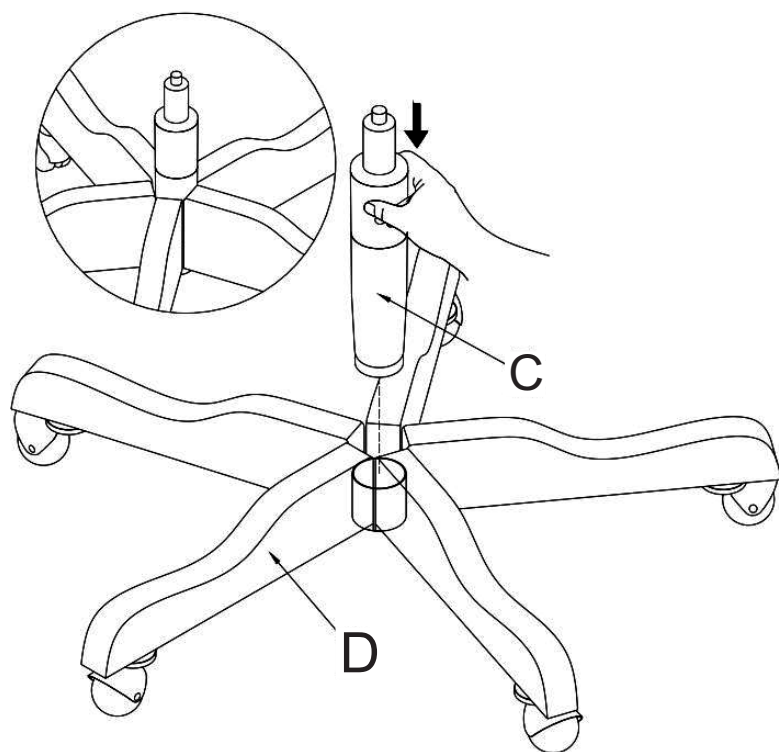

Step 2



Step 3

1	x4	2	x1
			
M6*20mm		M6	

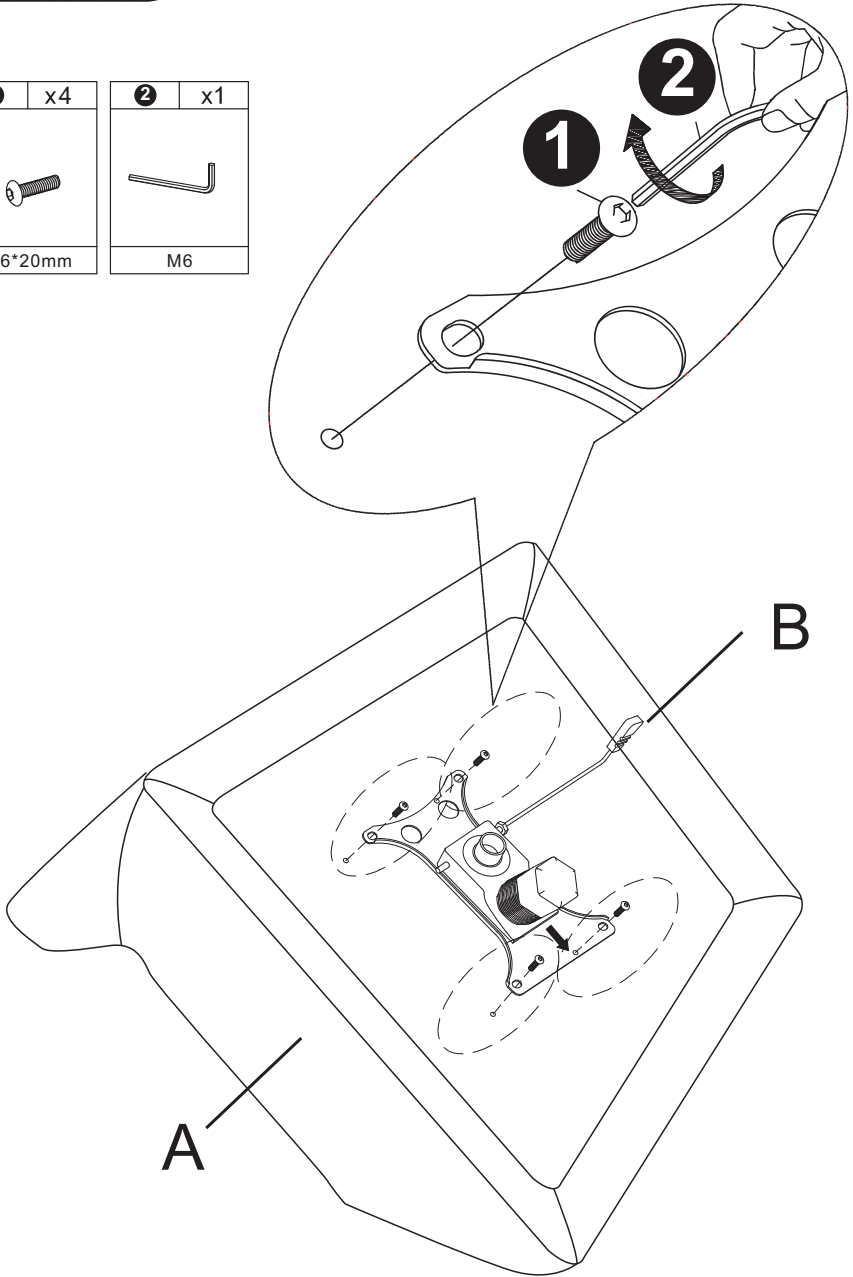

Step 4

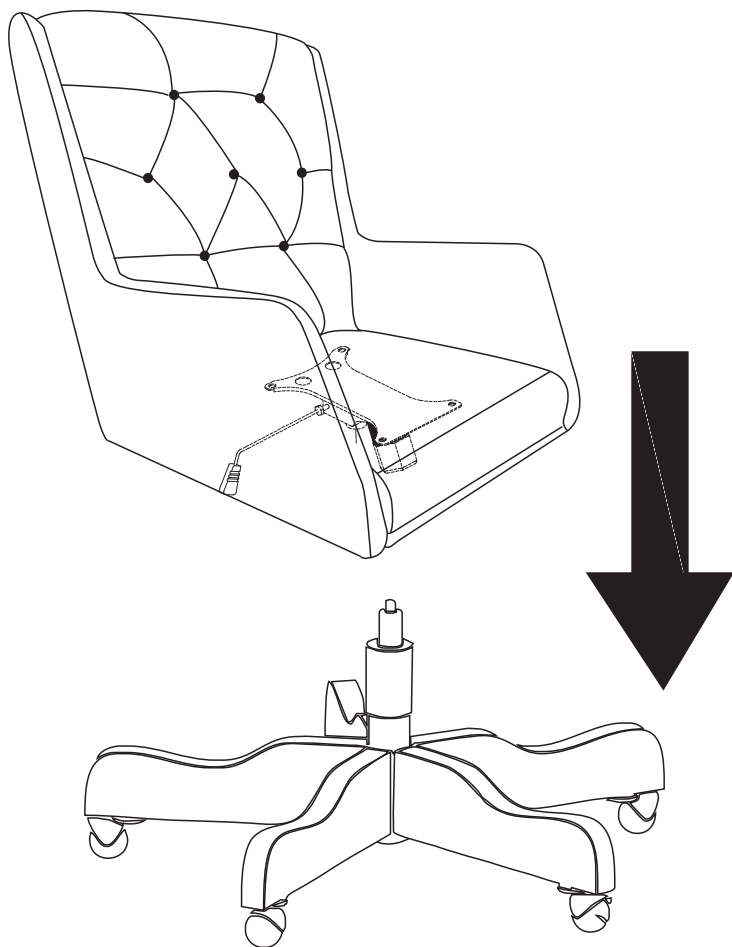

Step 5

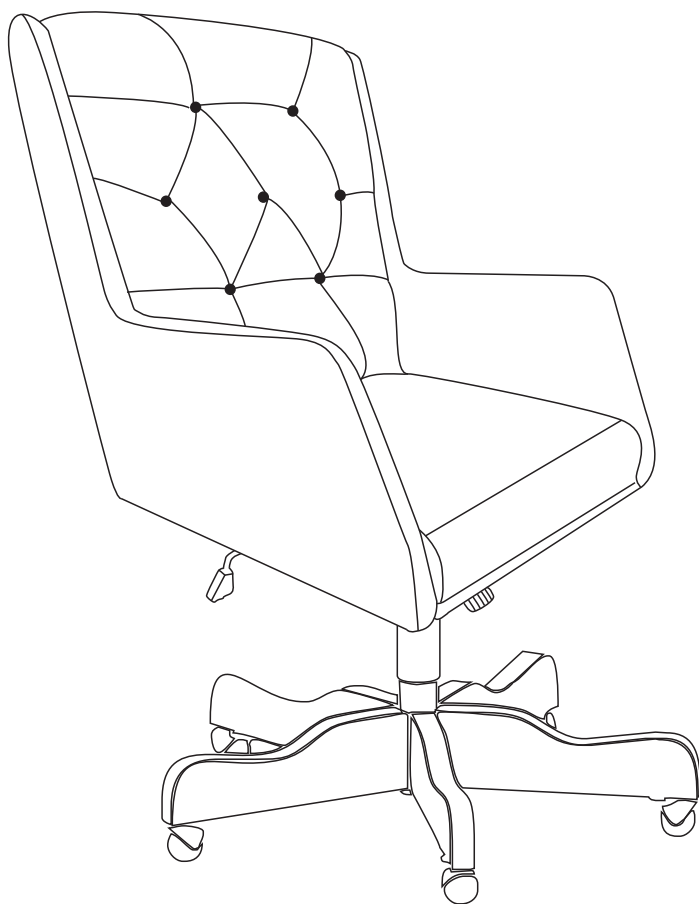

Assembly completed.

Functions Introduction

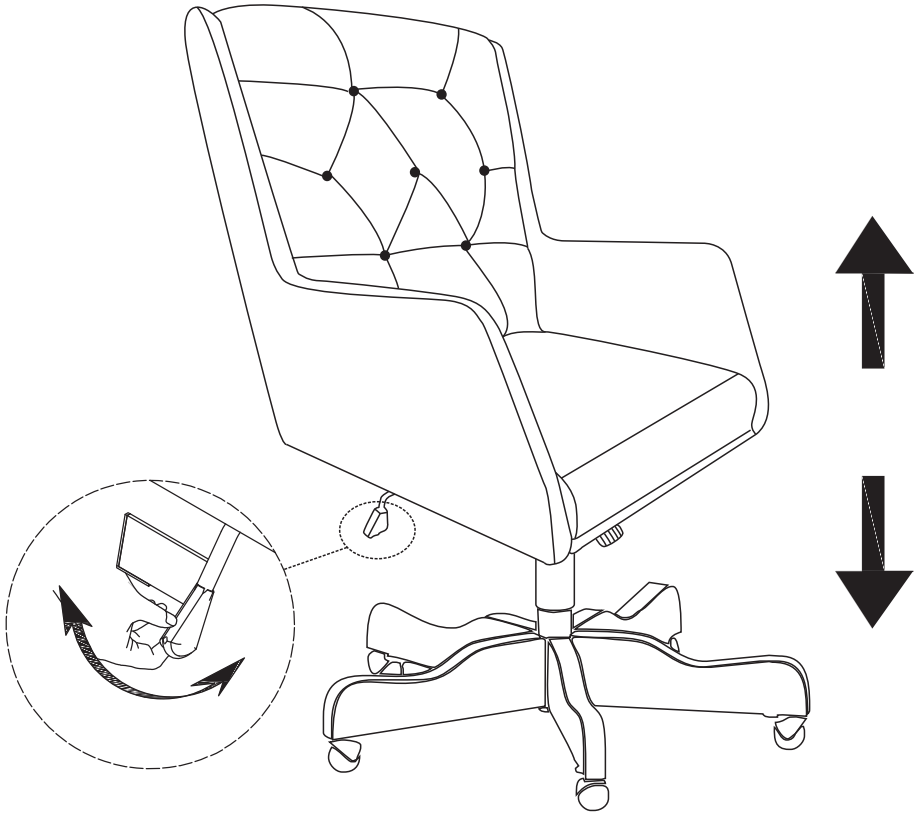

Adjust the chair height by pulling lifting lever

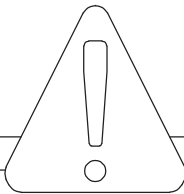

Functions Introduction

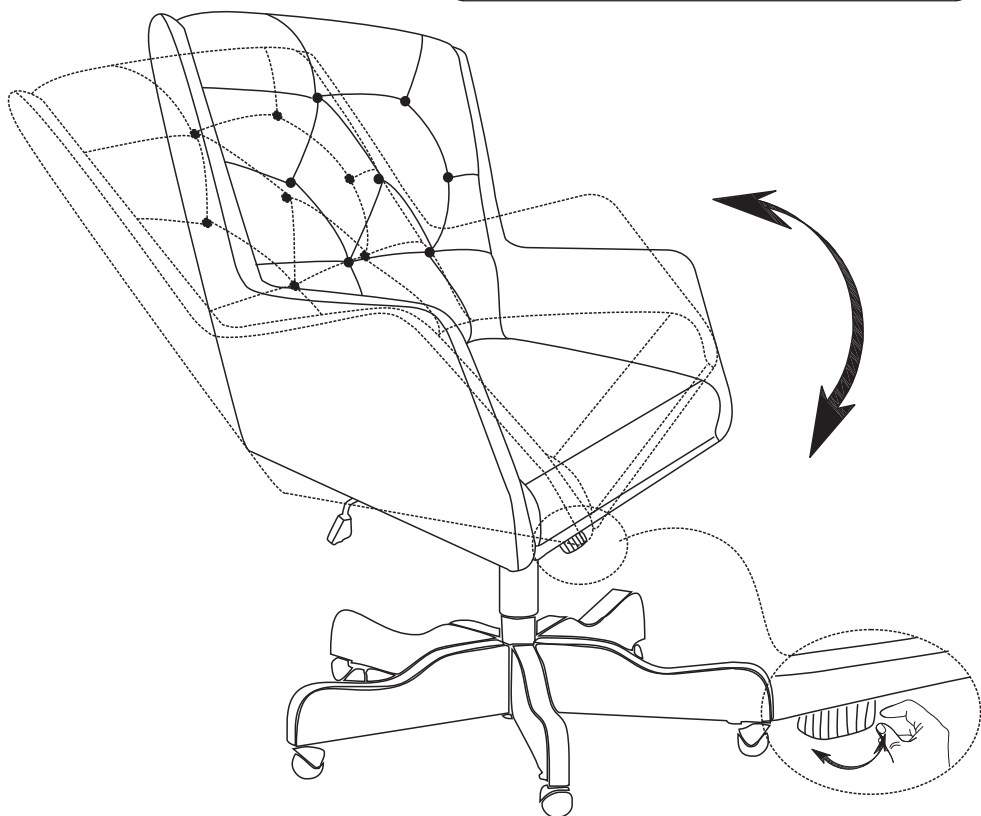

Rotate this knob clockwise to adjust the recline angle of the backrest; counterclockwise to adjust the backrest forward.



WARRANTY

- We strive to offer quality products, and we also try our best to satisfy every customer who orders from us with products or services as needed.
- Replacement parts can be purchased from our company if available.
- For returns, please check the return policy with the retailer or marketplace where you purchased the item.