



## WARNING!

Children have died from furniture tipover. Fixed wall device have been included with this product;you must install the fixed wall device according to these instructions in order to minimize the risk of furniture.If you have any questions about this product or the Fixed wall device , please contact us immediately.

Never allow children to climb or hang on furniture,including drawers or cabiner doors.







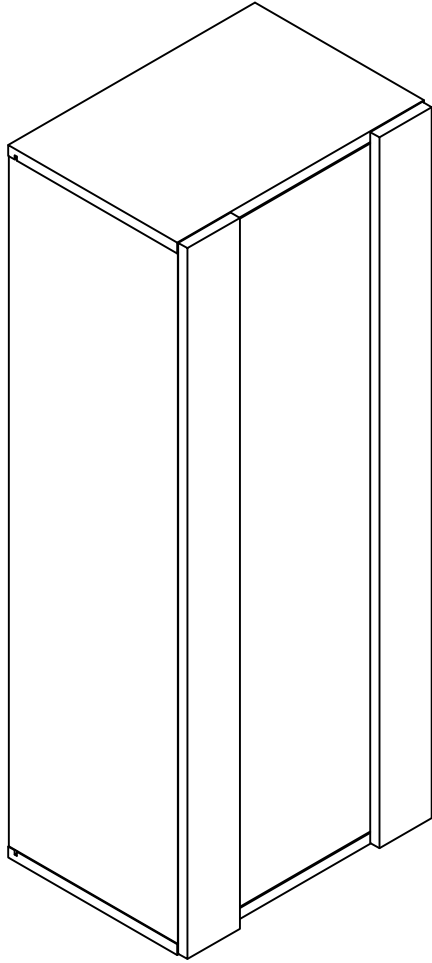

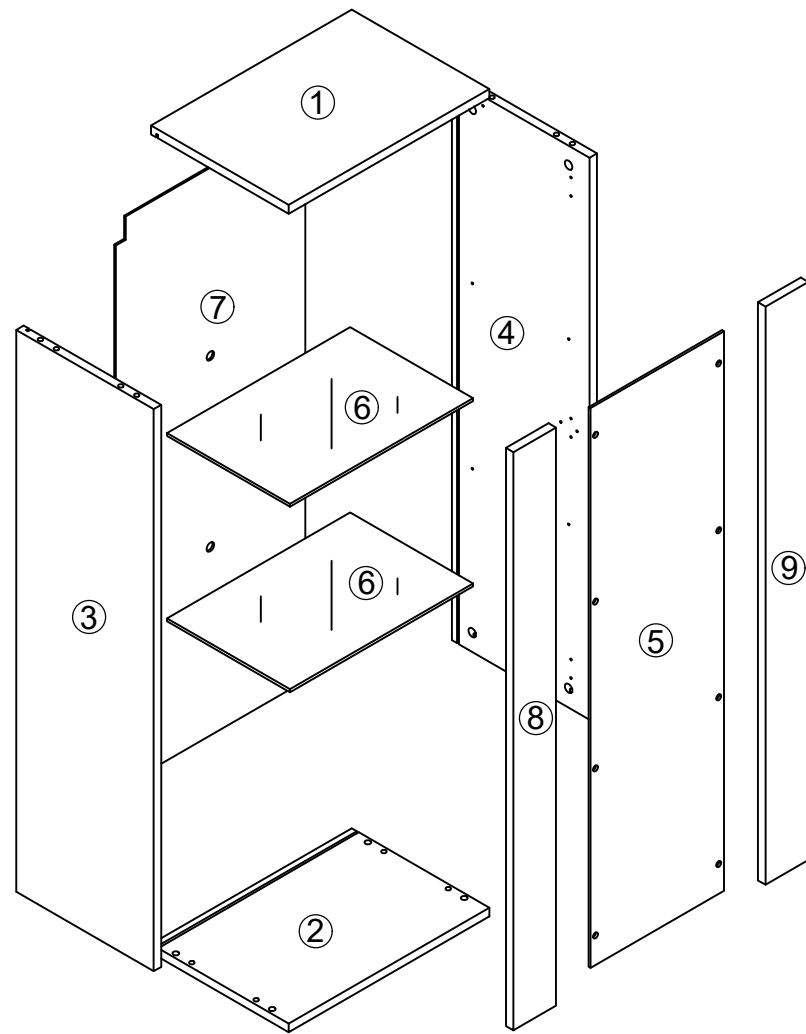



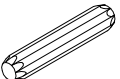
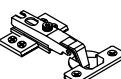

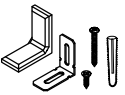
In addition to installing the restrains,to help prevent tip-over.

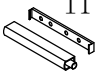
1. Never put a TV or other heavy objects on top of this product.
2. Do not stand on the product.

<b>⚠ WARNING</b>	
	<p><b>Children have died from furniture tipover. To reduce the risk of furniture tipover:</b></p> <ul style="list-style-type: none"><li>• ALWAYS install tipover restraint provided.</li><li>• NEVER put a TV on this product.</li><li>• NEVER allow children to stand, climb or hang on drawers, doors, or shelves.</li><li>• NEVER open more than one drawer at a time.</li><li>• Place heaviest items in the lowest drawers.</li><li>• Do not defeat or remove the drawer interlock system.</li></ul>
	<p><i>This is a permanent label. Do not remove!</i></p>

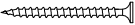
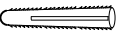
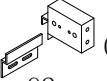



<p>A</p>  <p>8PCS</p>	<p>B</p>  <p>8PCS</p>	<p>C</p> <p>8*40</p>  <p>8PCS</p>	<p>D</p>  <p>3PCS</p>	<p>E</p> <p>3.5*14</p>  <p>28PCS</p>	<p>F</p> <p>3.5*25</p>  <p>12PCS</p>	<p>G</p>  <p>1PCS</p>	<p>H</p>  <p>8PCS</p>	<p>I</p>  <p>I1</p>  <p>I2</p> <p>1PCS</p>	<p>J</p>  <p>4PCS</p>
<p>K</p> <p>3*12</p>  <p>10PCS</p>	<p>L</p>  <p>10PCS</p>	<p>M</p> <p>4*50</p>  <p>4PCS</p>	<p>N</p> <p>8*40</p>  <p>4PCS</p>	<p>O</p>  <p>01</p> <p>02</p> <p>2PCS</p>	<p>P</p>  <p>8PCS</p>	<p>Q</p> <p>6*10</p>  <p>8PCS</p>	<p>LED</p>  <p>1PCS</p>		

1

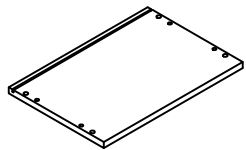

400\*274 1PS

2

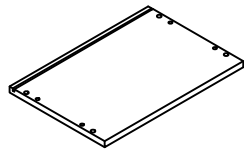

400\*274 1PS

3

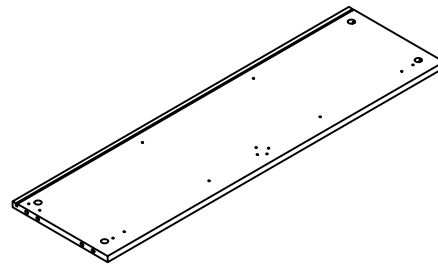

970\*274 1PS

4

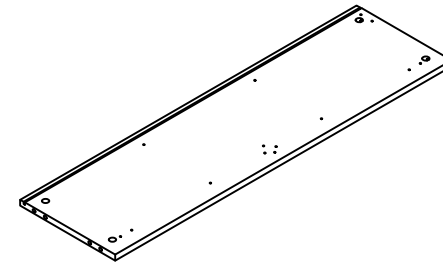

970\*274 1PS

5

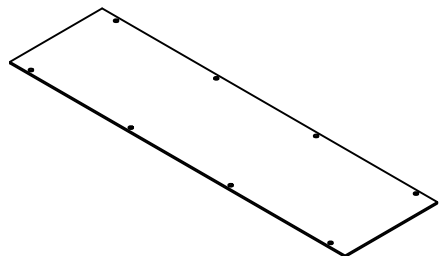

966\*266 1PS

6

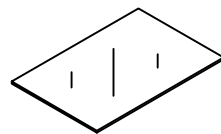

365\*245 2PS

7

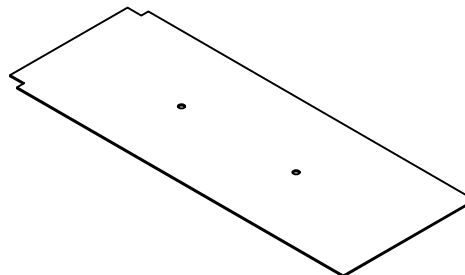

980\*378 1PS

8

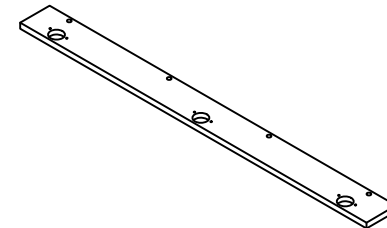

998\*85 1PS

9

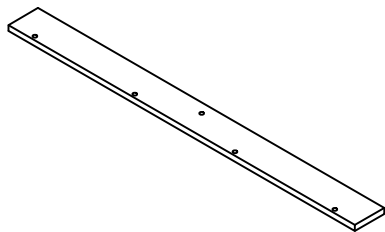

998\*85 1PS

AA

AA:On the floor

If you want to put the cabinet on the floor, please assemble to step 10.

WALL

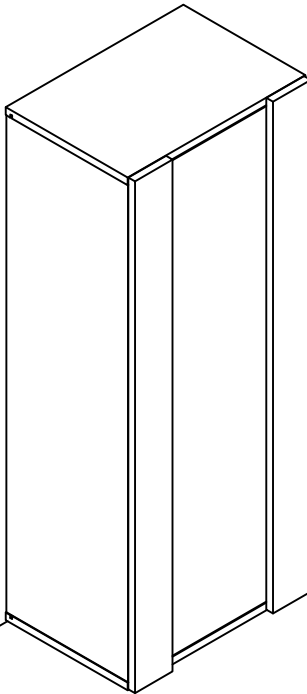

AB

AB:Mount on the wall

If you want to mount the cabinet on the wall, please skip step 2&10 and then assemble to end as original manual.

WALL

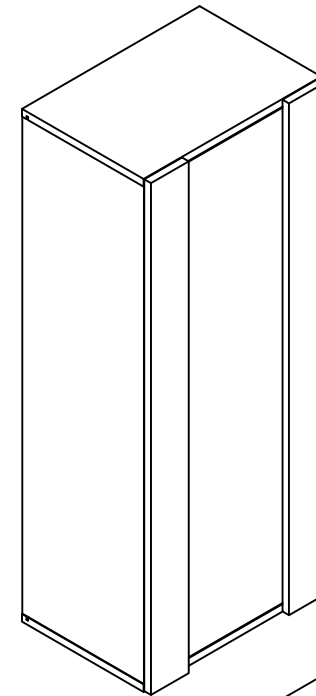



## Hardware installation demonstration

NOTE: Please make sure "A" hardware tightened and can't be pulled out!

I

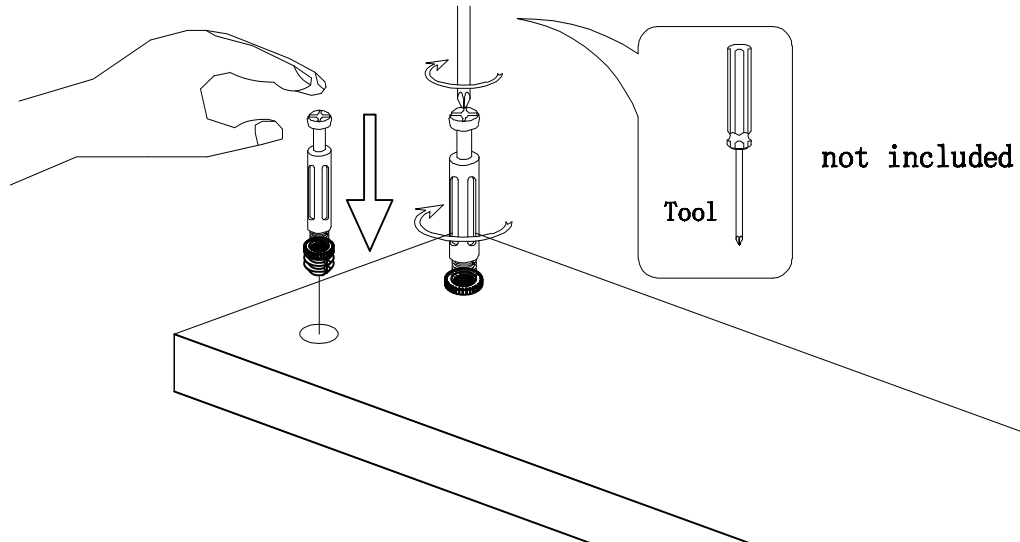

II

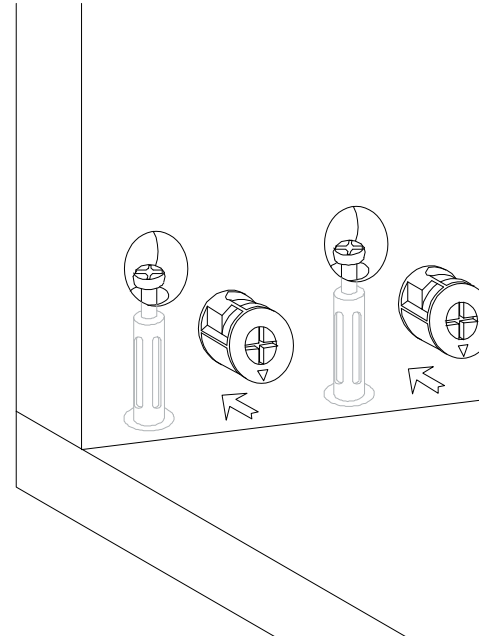



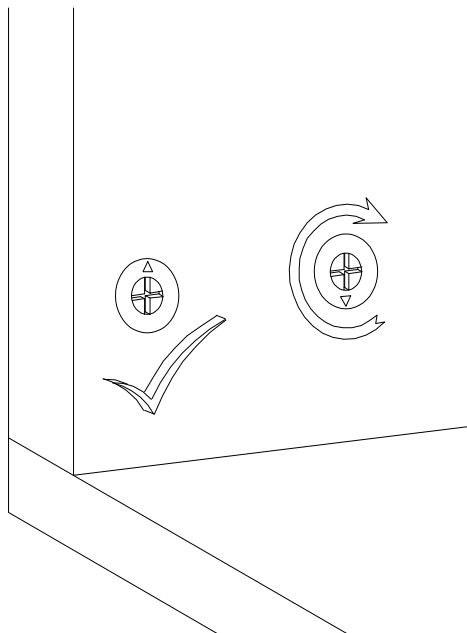

III

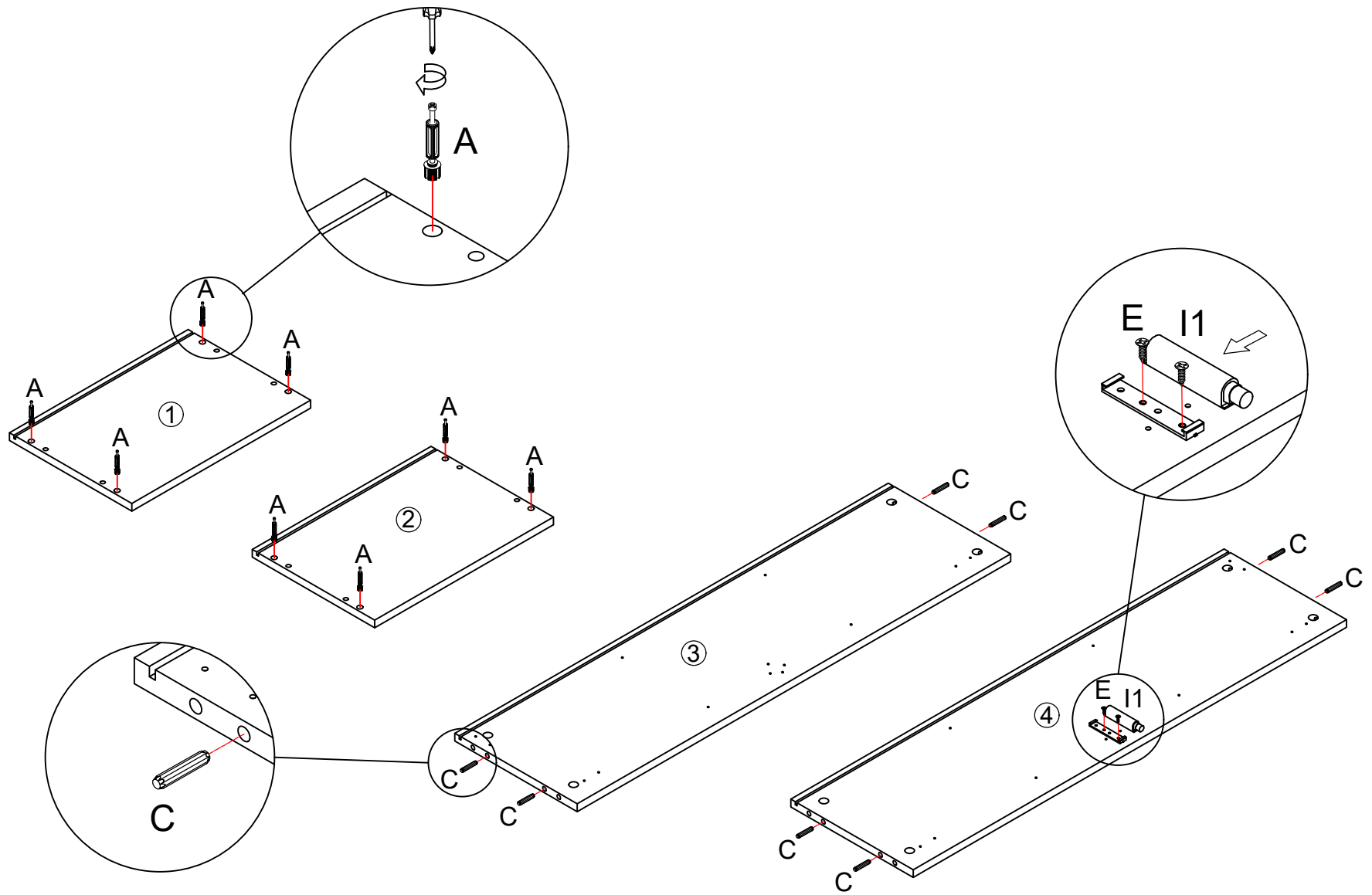

1



	A*8		E*2
	C*8		I1*1

2

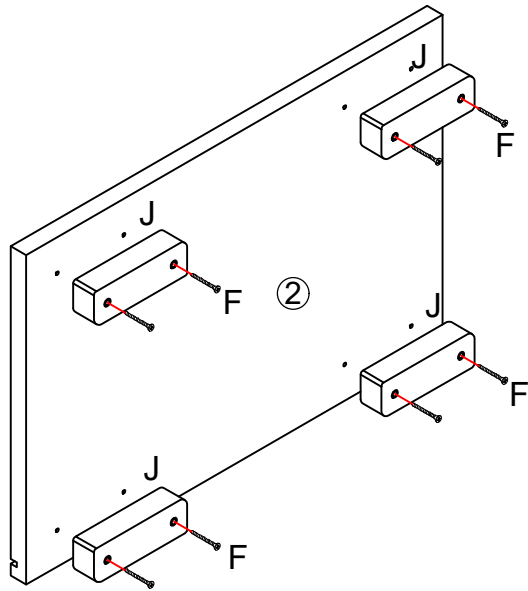

F\*8



J\*4

3

Make sure the arrow on the screw align to the hole on the side.

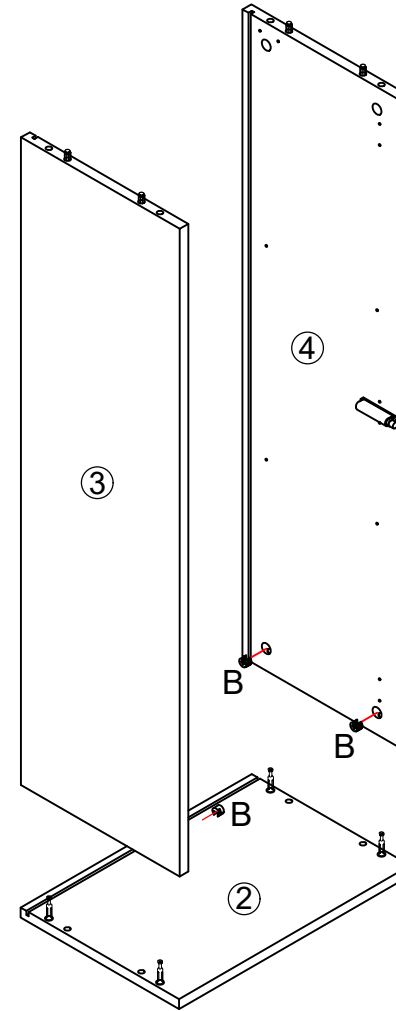
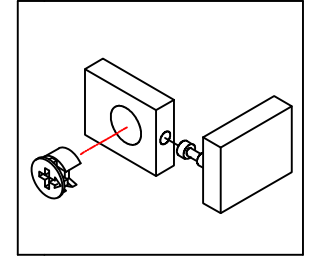

B\*4

4

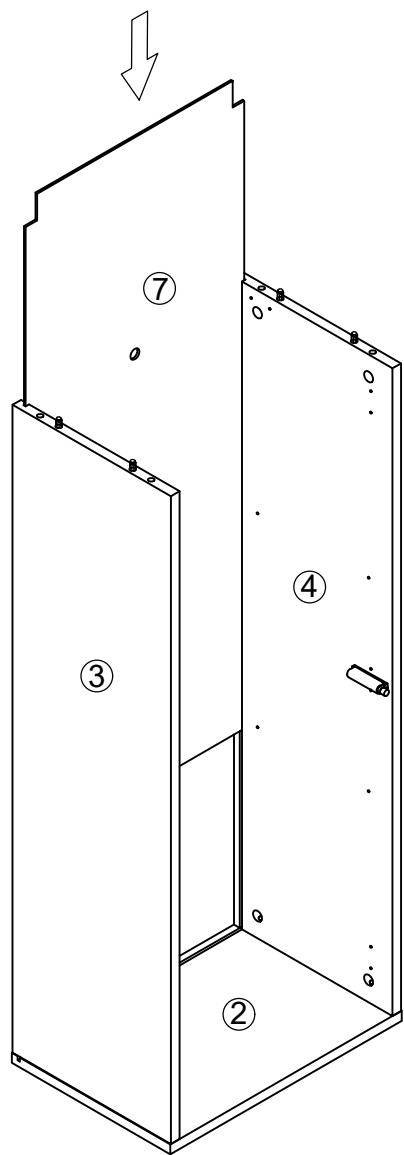

5

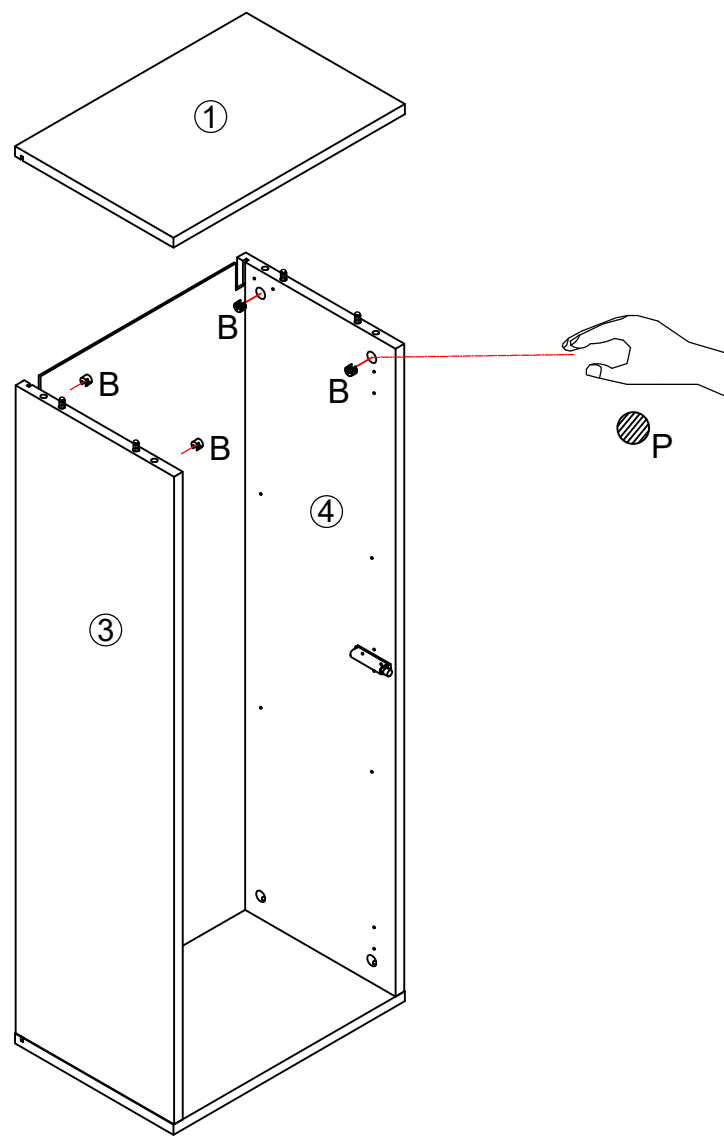



B\*4



P\*8

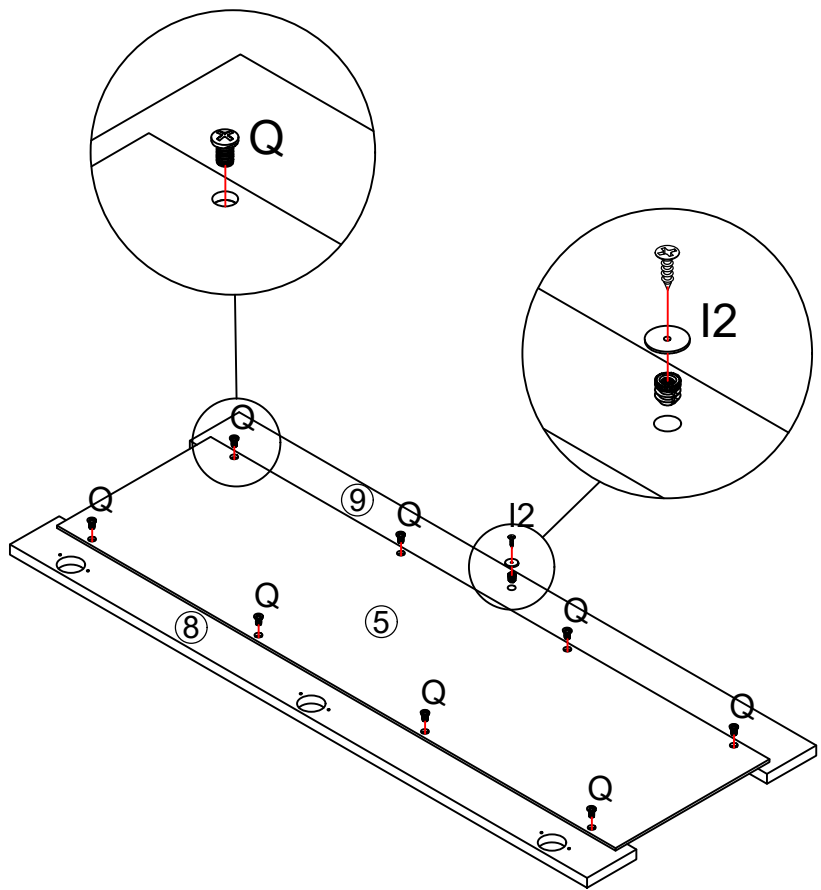

6



	I2*1
	Q*8

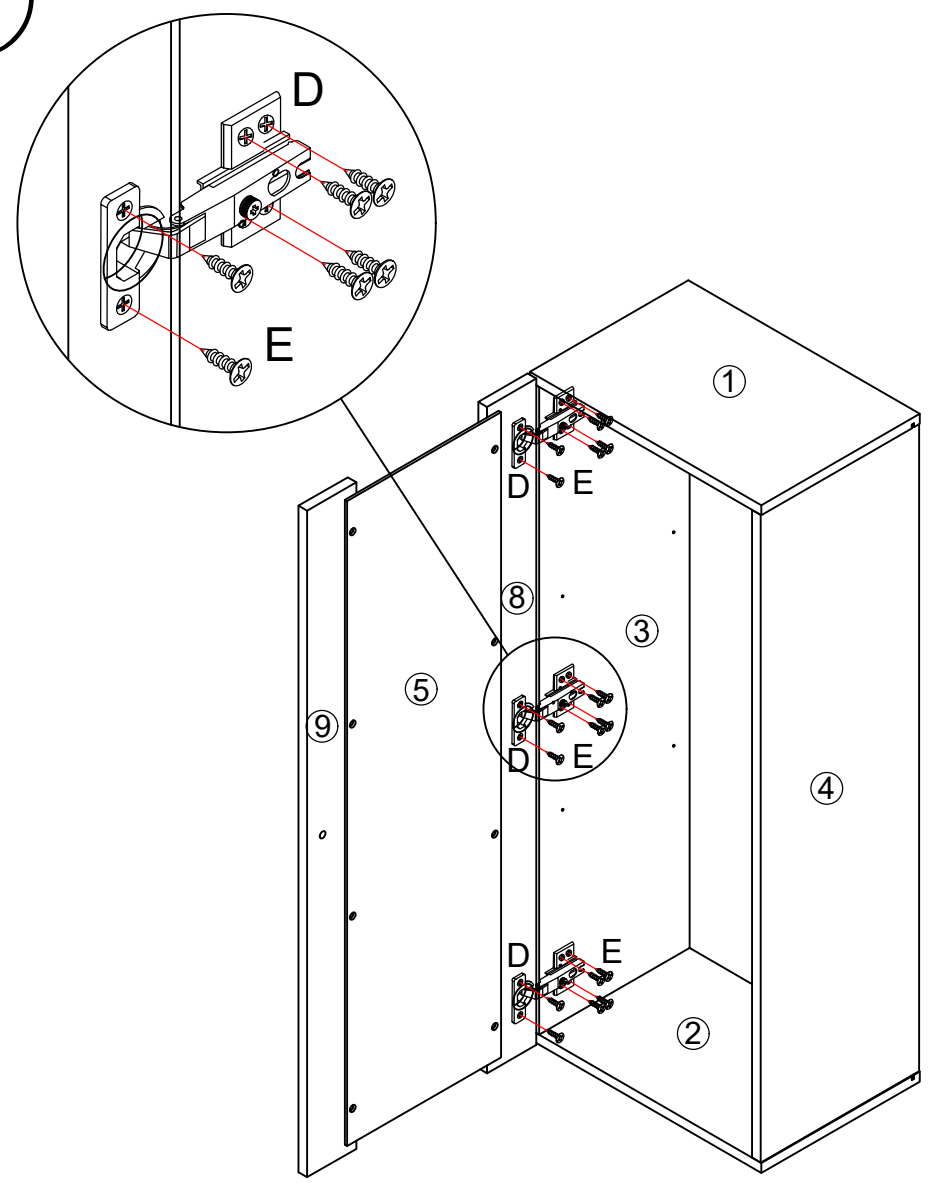

7



	D*3
	E*18

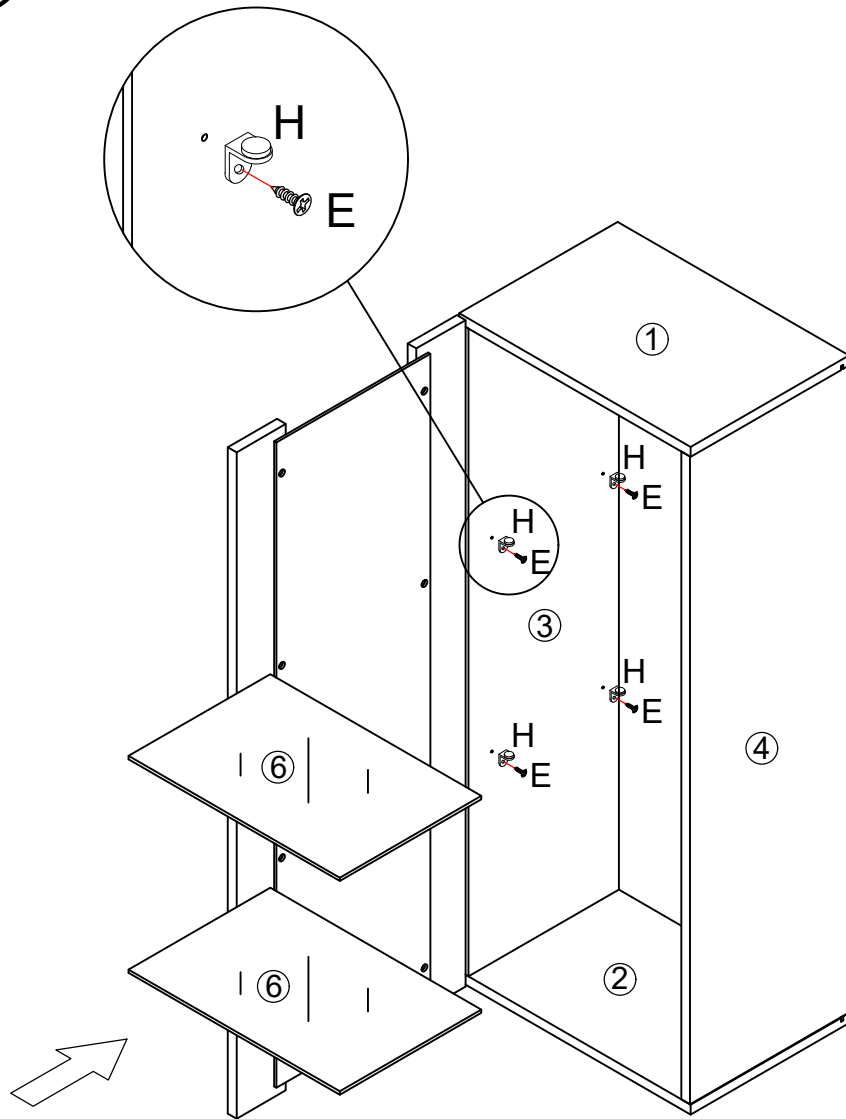

8

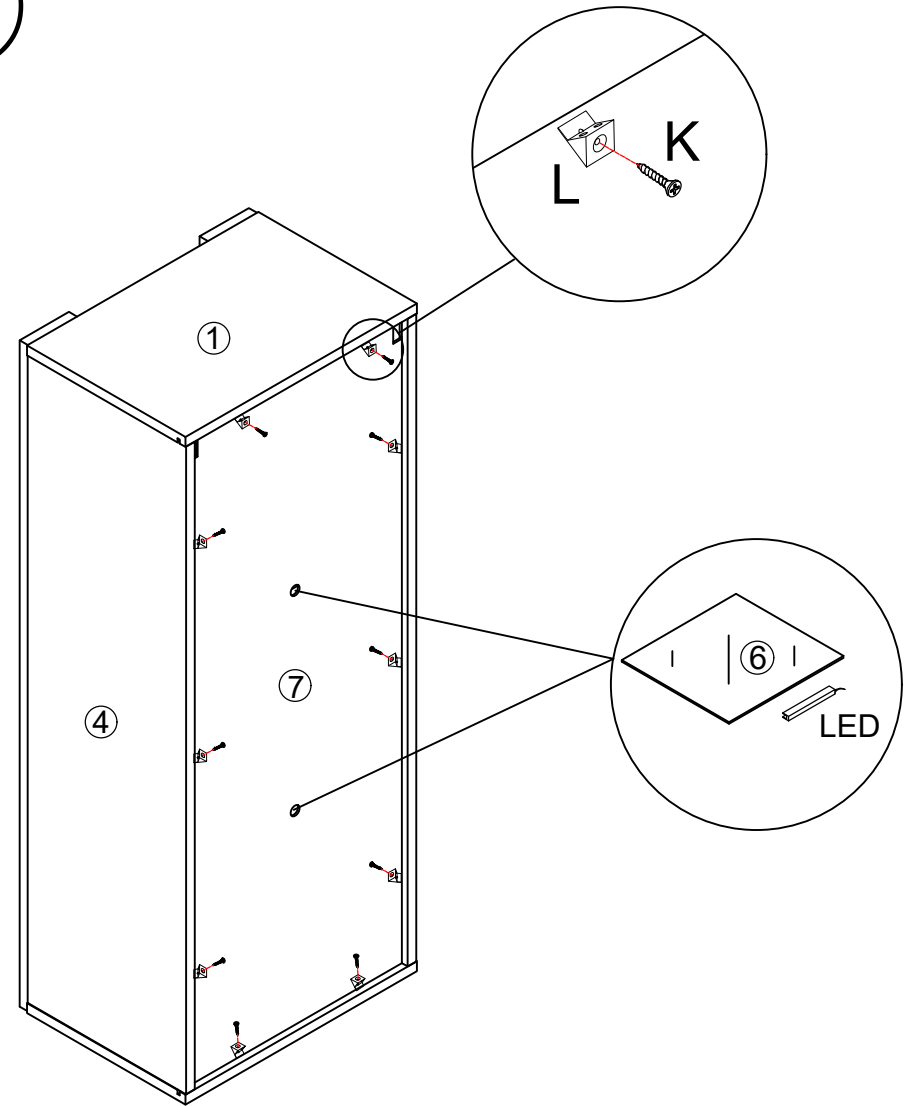

	E*8
	H*8

9



	K*10		
	L*10		LED*1

10

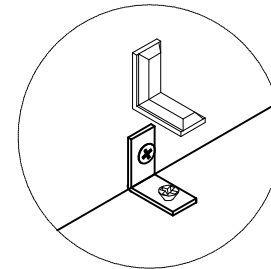
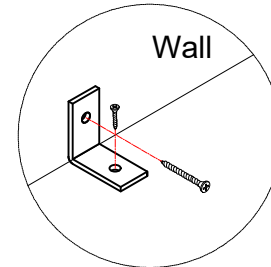
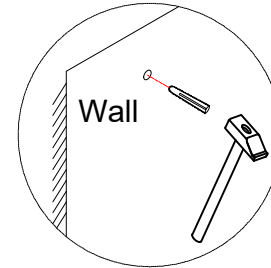
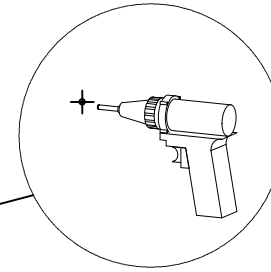
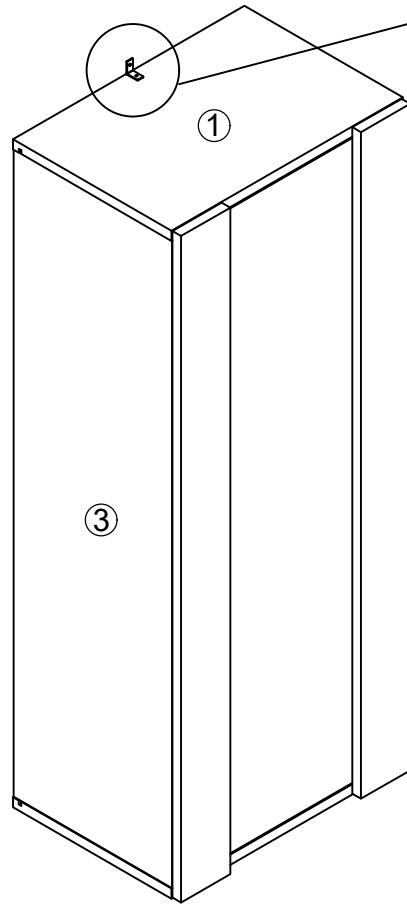

G\*1

Please install tip-proof fitting.

11

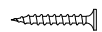
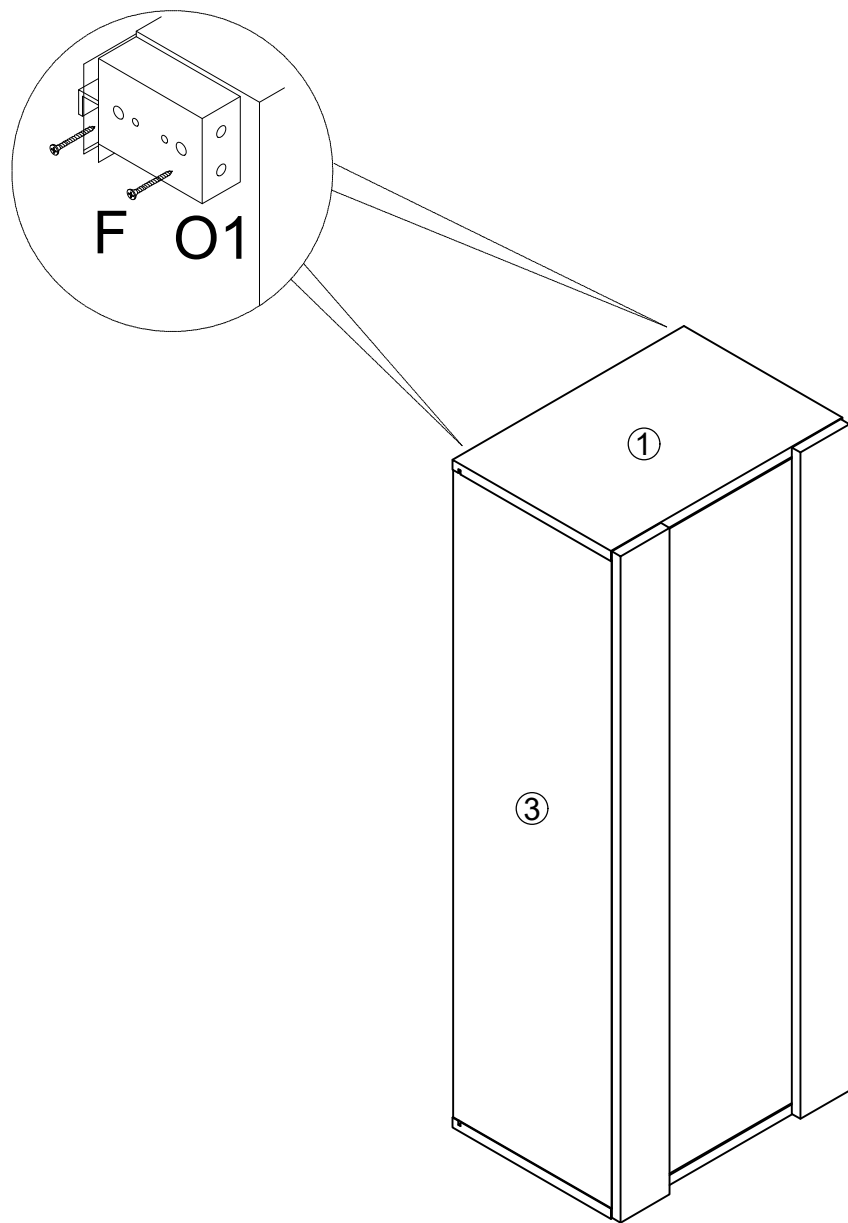



F\*4

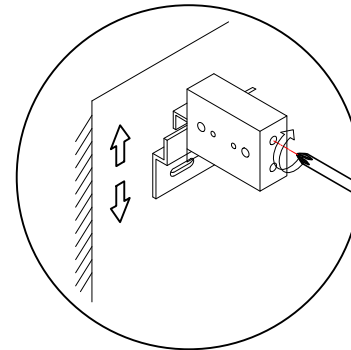
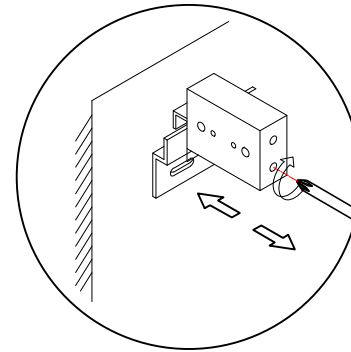
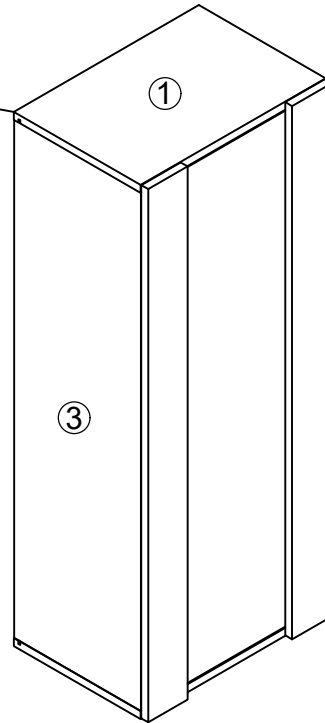
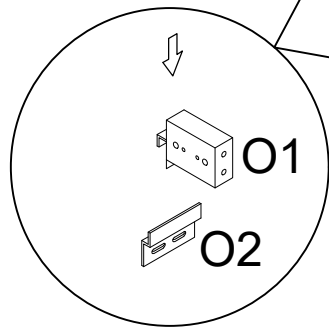
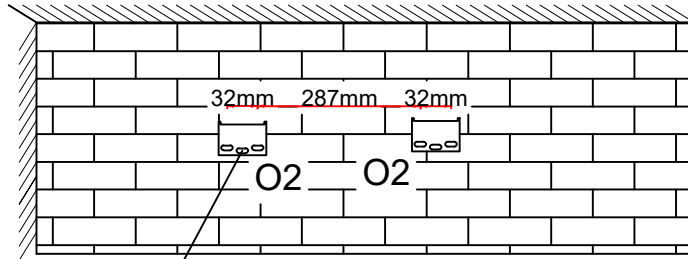
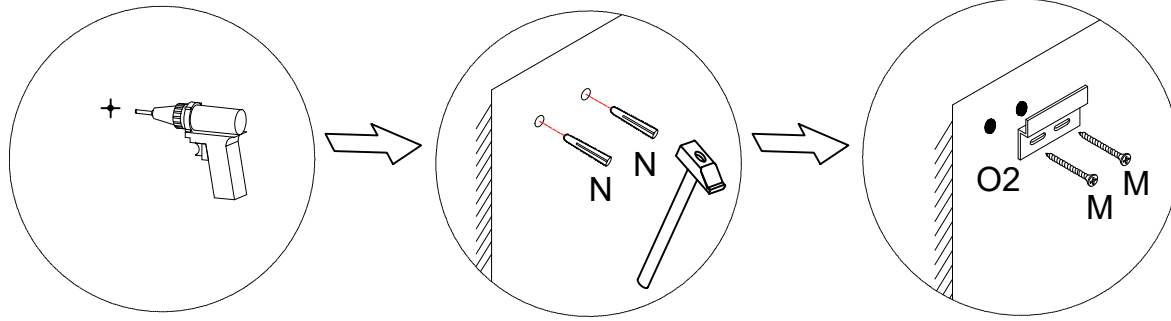

O1\*2

12

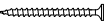

	M*4
	N*4
	O2*2