

ASSEMBLY INSTRUCTION

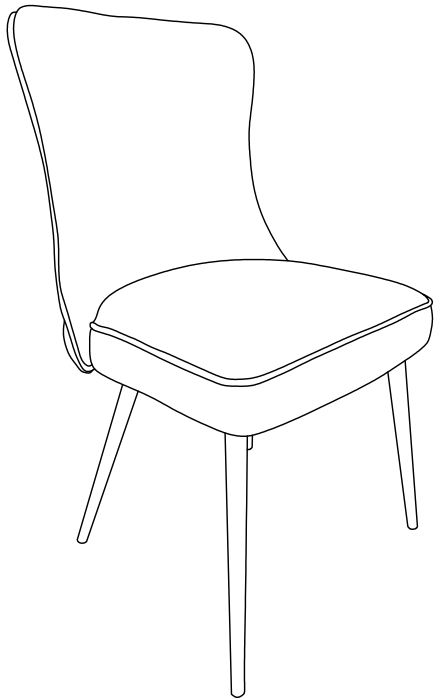

A x 1

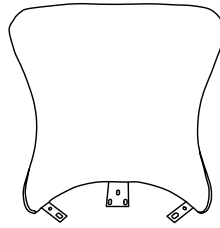

E x 7

M6*20



F x 1

M6*30



B x 1

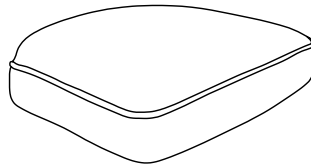

G x 4

M6*45



H x 1

M6



C x 1

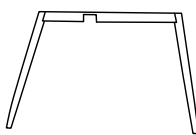

D x 1

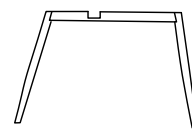

I x 12

M6*15



1

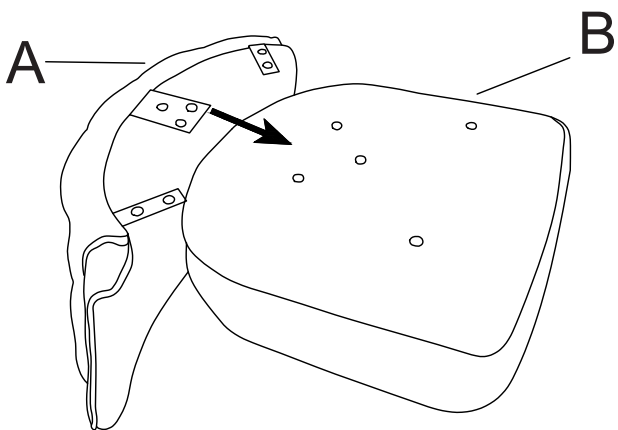

2

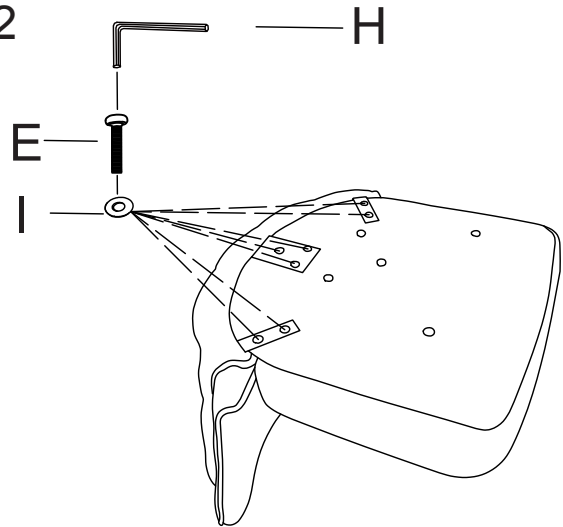

3

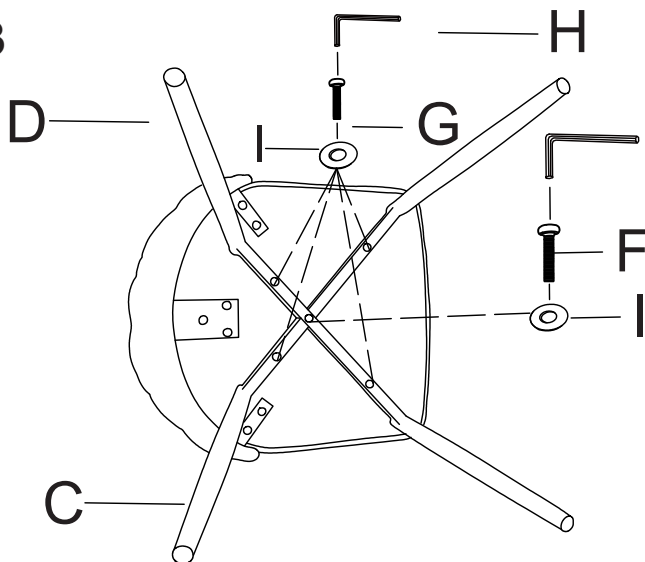

4

