

# RVH5003

TOPMOUNT WORKSTATION SINK

**RUVATI**<sup>®</sup>  
SPECIFICATION SHEET

## MATERIAL

- True 16 Gauge Thickness
- Premium T304 Grade Stainless Steel
- Nano-PVD colored finish: easy to clean, and long lasting

## FEATURES

- Heavy duty sound guard padding and undercoating
- Slanted bottom with elegant drain grooves for easy draining
- Rounded inside corners

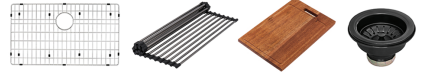

## COLOR OPTIONS

**BL:** Black Stainless Steel

**GG:** Matte Gold Brass Tone

## IN THE BOX

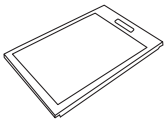

Cutting Board  
[RVA1217]

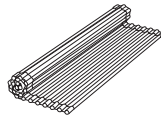

Rollup Rack  
[RVA1385BL /GG]

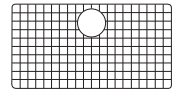

Rinse Grid  
[RVA68003]



Basket Strainer  
[RVA1022BL /GG]



Mounting Clips  
[RVA11048]



Cut-out  
Template

## NOMINAL DIMENSIONS

Exterior: 33" (wide) x 22" (front-to-back)

Interior Bowl: 31" (wide) x 16" (front-to-back)

Bowl Depth: 9"

Minimum Cabinet Size: 36" wide

Drain Hole Size: 3½"

Installation Type:  
Topmount

Inside Corners:  
Rounded

Drain Location:  
Rear Center

**RUVATI USA**

www.ruvati.com

Phone: 1.855.478.8284  
Email: support@ruvati.com

## OPTIONAL ACCESSORIES (SOLD SEPARATELY)

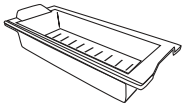

Colander  
[RVA1367BLK]

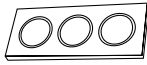

Condiment  
Serving Tray  
[RVA1377BWC]

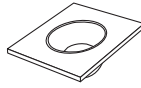

Mixing Bowl  
and Platform  
[RVA1288BWC]



Caddy  
[RVA1580]

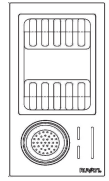

Drying Rack  
[RVA1542BWC]

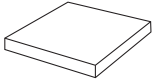

Butcher Block  
[RVA2445ACA]



Garbage  
Disposal Flange  
[RVA1041BL/GG]



Deep Basket  
Disposal Flange/Stopper  
[RVA1052BL/GG]



Deep Basket Strainer  
and Stopper  
[RVA1027BL/GG]

## DIMENSIONS

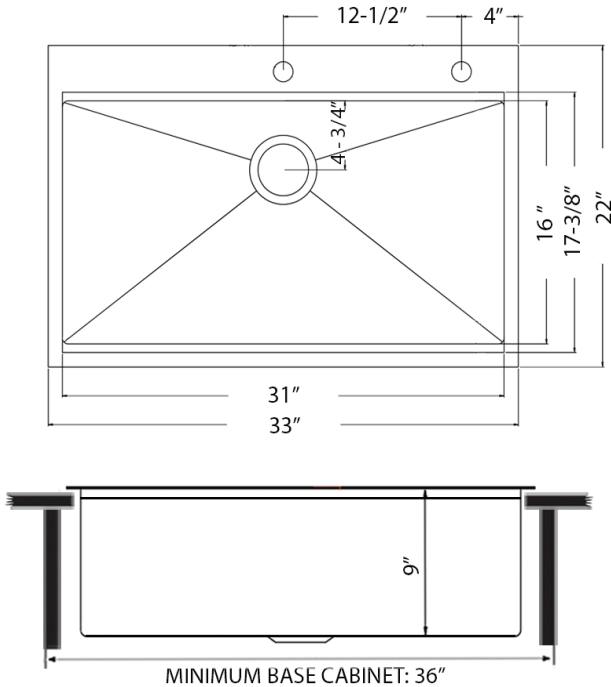

cUPC certified by IAPMO  
to meet US and Canada  
plumbing standards.



**SCAN TO REGISTER  
YOUR WARRANTY**

or visit  
[ruvati.com/register](http://ruvati.com/register)

# RUVATI USA

[www.ruvati.com](http://www.ruvati.com)

Phone: 1.855.478.8284  
Email: [support@ruvati.com](mailto:support@ruvati.com)