

ASSEMBLY INSTRUCTIONS

BED - QUEEN

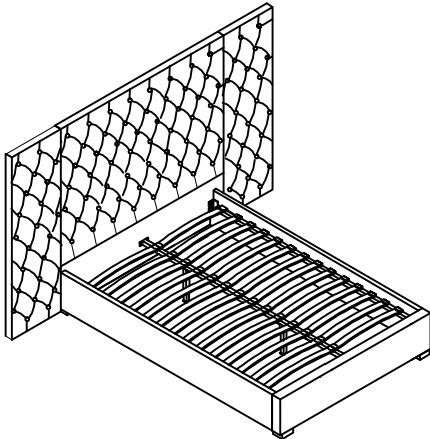

+ Parts Included

① Head Board (1pc)

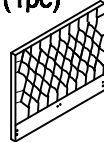

② Foot Board (1pc)

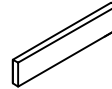

③ Side Rails (2pcs)

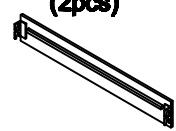

④ Double Plastic cap (15pcs)



⑤ Center Support Bar (1pc)



⑥ Support Legs (2pcs)



⑦ Slats (30pcs)

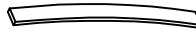

⑧ Single Plastic cap (30pcs)



⑨ Legs (4pcs)



*Slats come packed in the bottom of headboard carton.

⑩ Left wing (1pc)



⑪ Right wing (1pc)



⑫ Connector (4pcs)

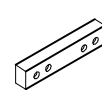

+ Do Not Use Power Tools

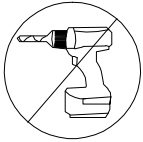

+ Suggested Adults

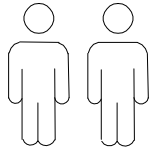

NOTE:

- 1 Read instructions cover to cover.
- 2 Save all packaging until assembly is completed.

1 IMPORTANT SAFETY INFORMATION

Do not assemble the product if any of the following parts arrived damaged:

- Part #③ -Side Rails
- Part #⑤ -Center Support Bar
- Part #⑥ -Support Legs
- Part #⑦ -Slats

2 IMPORTANT ASSEMBLY INFORMATION

Assembly Step ③ Ensure the side rail bracket is fully hooked onto bolt A loosely threaded with both washers on the OUTSIDE of the bracket first, then proceed to fully tightening all 4 corners.

Assembly Step ⑦ When installing slats, ensure that the curve is facing upwards. (→) (↘)
*Slats come packed in the bottom of headboard carton.

+ Hardware Included

A Bolt M8*30mm (16pcs)



B Bolt M6*70mm (8pcs)



C Bolt M8*45mm (16pcs)



D Spring Washer (8pcs)



E Flat Washer $\phi 20$ (24pcs)



F M8 Allen Key (1pc)



G Flat Washer $\phi 22$ (16pcs)



H M4 Allen Key (1pc)



I Nut M8*13mm (4pcs)



J Spanner (1pc)



ASSEMBLY INSTRUCTIONS

BED - QUEEN

