

# ASSEMBLY INSTRUCTION

## ASSEMBLY TIPS:

1. Remove hardware from box and sort by size.
2. Please check to see that all hardware and parts are present prior to start of assembly.
3. Please follow attached instructions in the same sequence as numbered to assure fast & easy assembly.



### Warning!!



1. Don't attempt to repair or modify parts that are broken or defective. Please contact the store immediately.
2. This product is for home use only and not intended for commercial establishment.

**ASSEMBLY TIME PER UNIT:** 15 MINUTES

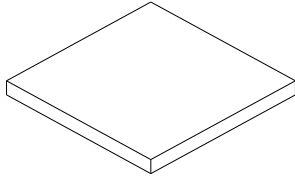
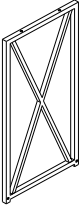
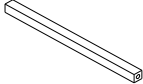
## PARTS IDENTIFICATION

<p><b>A</b></p> <p style="text-align: center;"></p> <p><b>TOP</b> <span style="float: right;"><b>1PC</b></span></p>	<p><b>B</b></p> <p style="text-align: center;"></p> <p><b>SIDE FRAME</b> <span style="float: right;"><b>2PCS</b></span></p>
<p><b>C</b></p> <p style="text-align: center;"></p> <p><b>CROSSBAR</b> <span style="float: right;"><b>2PCS</b></span></p>	

## HARDWARE PACKAGE

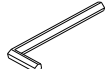
	DESCRIPTION	FIGURE	Q'TY
<b>1</b>	<b>SHORT BOLT</b>		<b>4PCS</b>
<b>2</b>	<b>LONG BOLT</b>		<b>4PCS</b>
<b>3</b>	<b>CAP</b>		<b>4PCS</b>
<b>4</b>	<b>ALLEN WRENCH</b>		<b>1PC</b>

# ASSEMBLY INSTRUCTION

## STEP 1

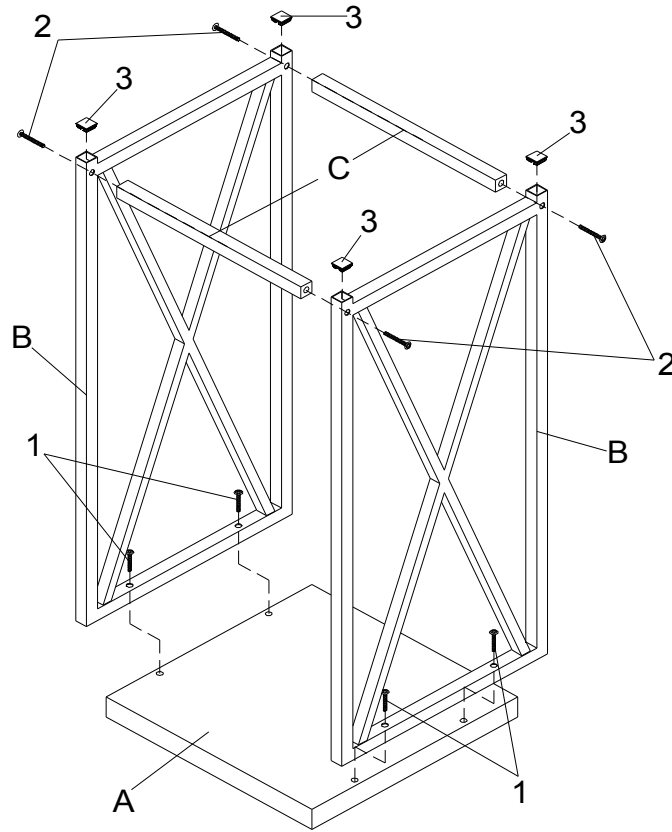

## FINISH

