

Assembly Instructions

CAUTION: You must read this before you proceed.

Please look in the Table Top for hardware packs.

TABLE

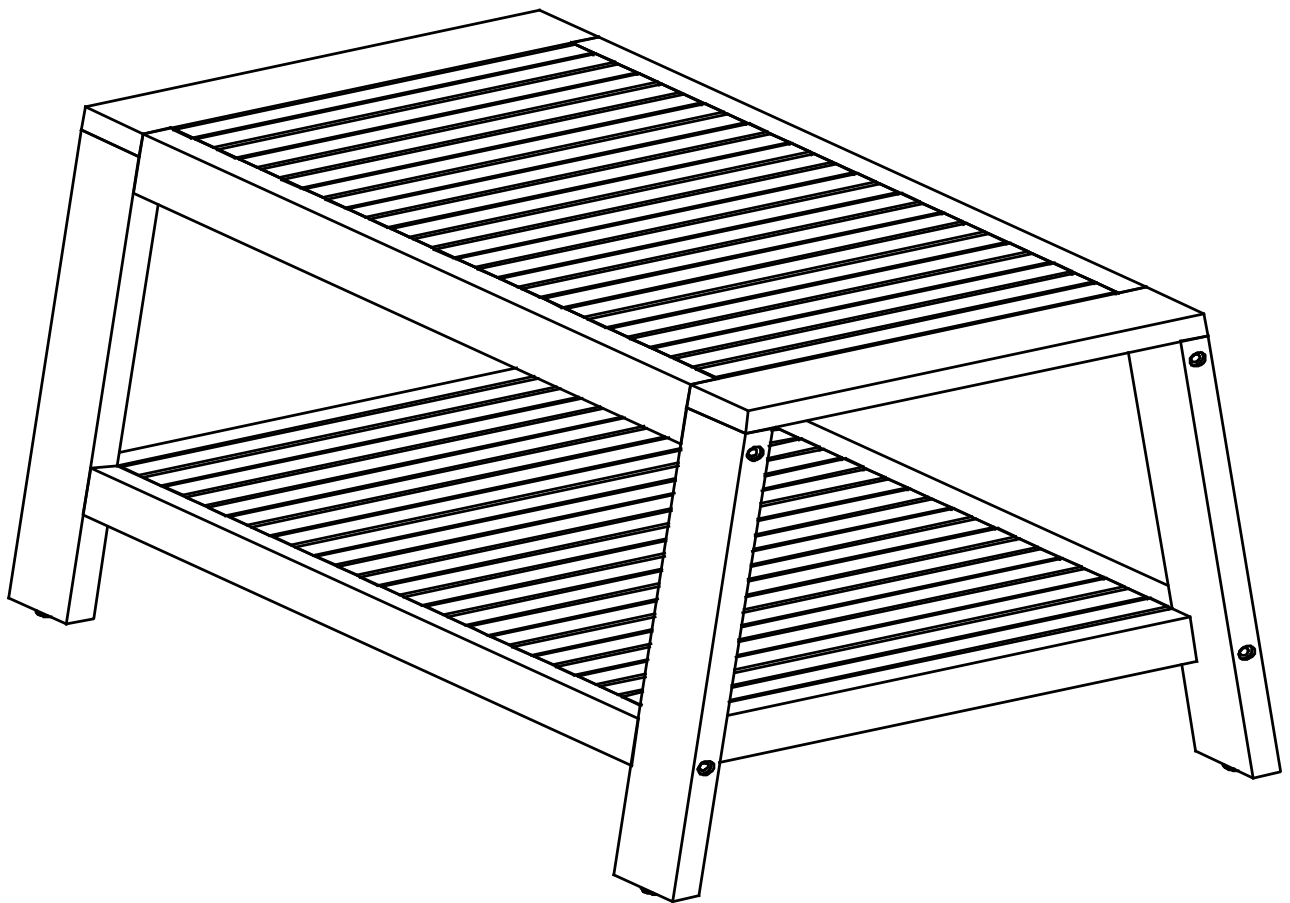



CAUTION : This Table is NOT a TOY. Keep your child / children at bay in the process of assembly.

For turning the Table and to prevent damage to the Table, 02 persons may be needed to execute this action.

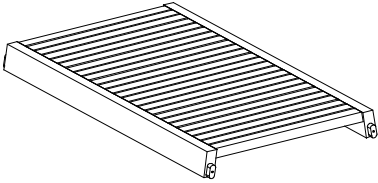
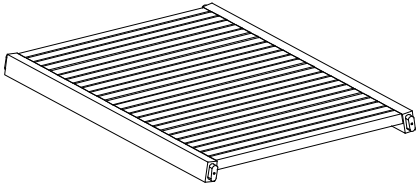
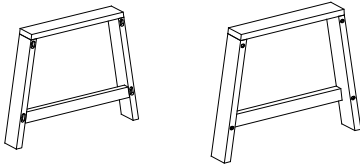
Parts List

No.	Picture	Description	Qty
A		Table top	1
B		Shelf Panel	1
C		Leg Panels	2





Hardware

No.	Picture	Description	Qty
①		Screws (M6x90 mm)	9
②		Allen Key	1

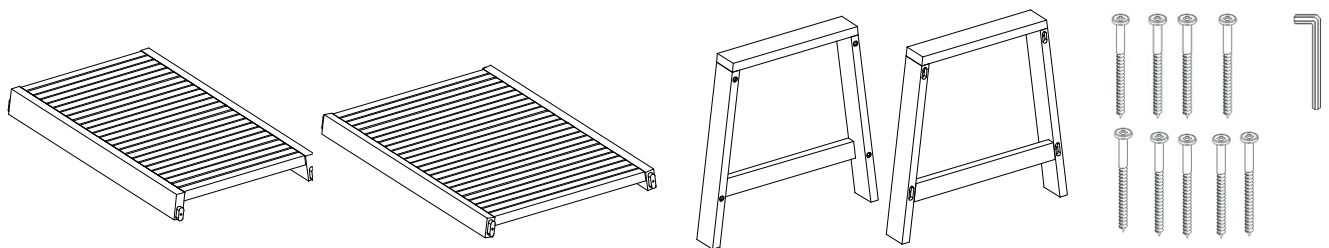
Assembly Preparation

Before Beginning Assembly:



-  Read instructions, cover to cover.
-  Have 2 adults on hand for assembly.
-  Do not assemble on flooring or carpet.
-  Assemble on a clean non-marring surface (packing foam).
-  Save all packaging until finished.

Assembly Steps

OVERVIEW

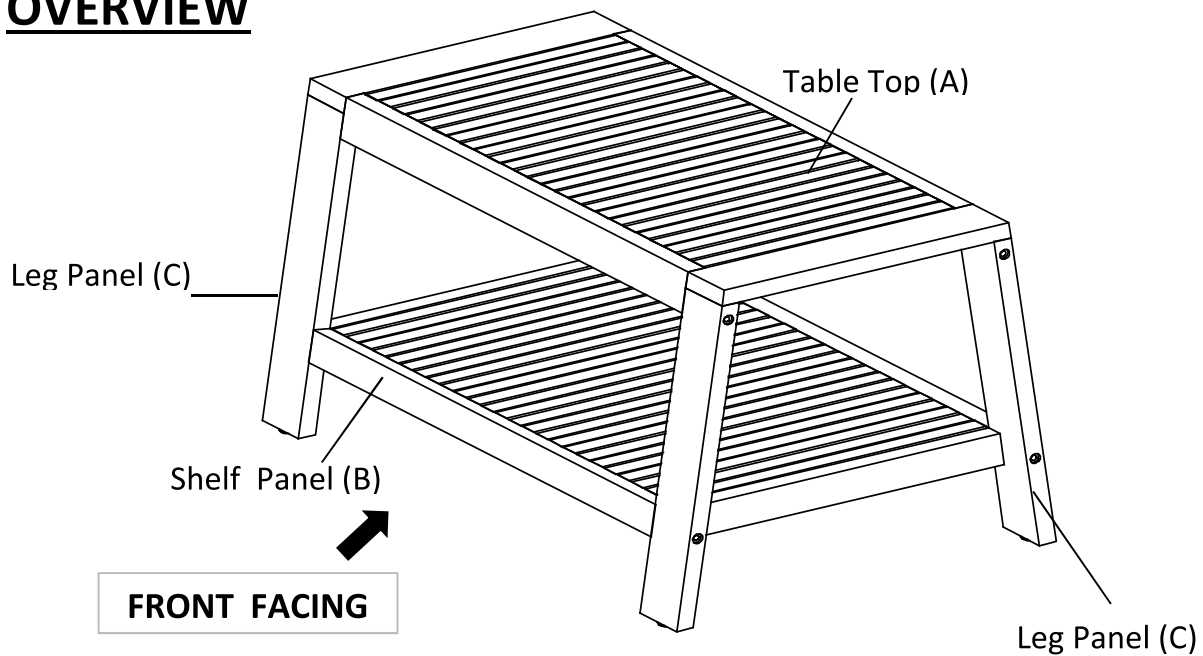

This Table has multiple parts and may require up to some 30 minutes to assemble. To give you an overview of the Table parts, the above picture is to help you put the various parts into perspective. Please read through the instructions here below to familiarise the parts and steps before assembly.

Step 1

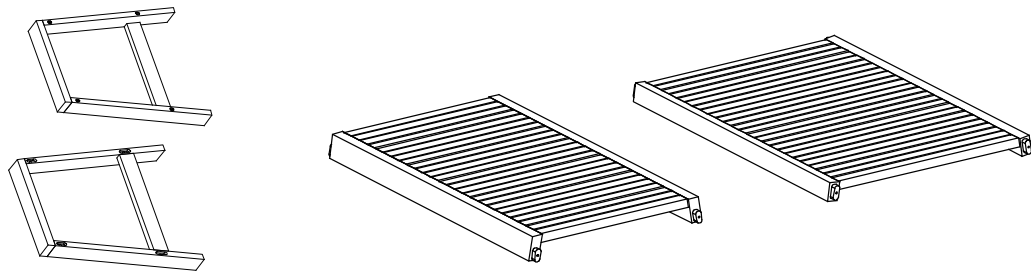

Unpack and place all parts on a clean non marring flat surface .

Step 2

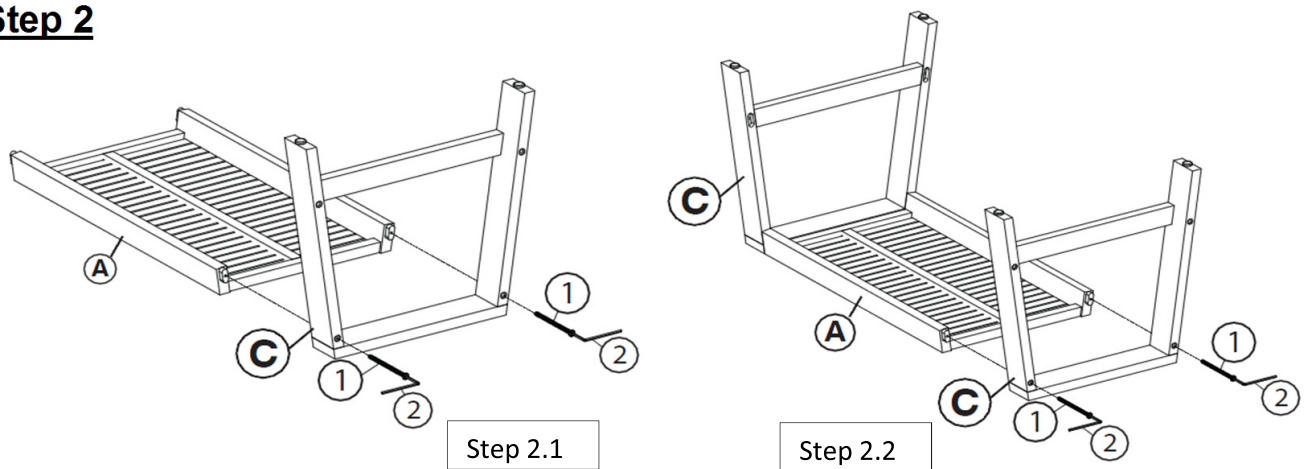

Step 2.1: Position Table Top (A) and Leg Panel (C) as shown in picture above.

Then affix 1st Leg Panel (C) to Table Top (A) by using Screws (①) and Allen Key (②).

Step 2.2: Repeat the same process to affix 2nd Leg Panel (C) to Table Top (A) by using Screws (①) and Allen Key (②)

DO NOT FULLY TIGHTEN SCREWS.

Step 3

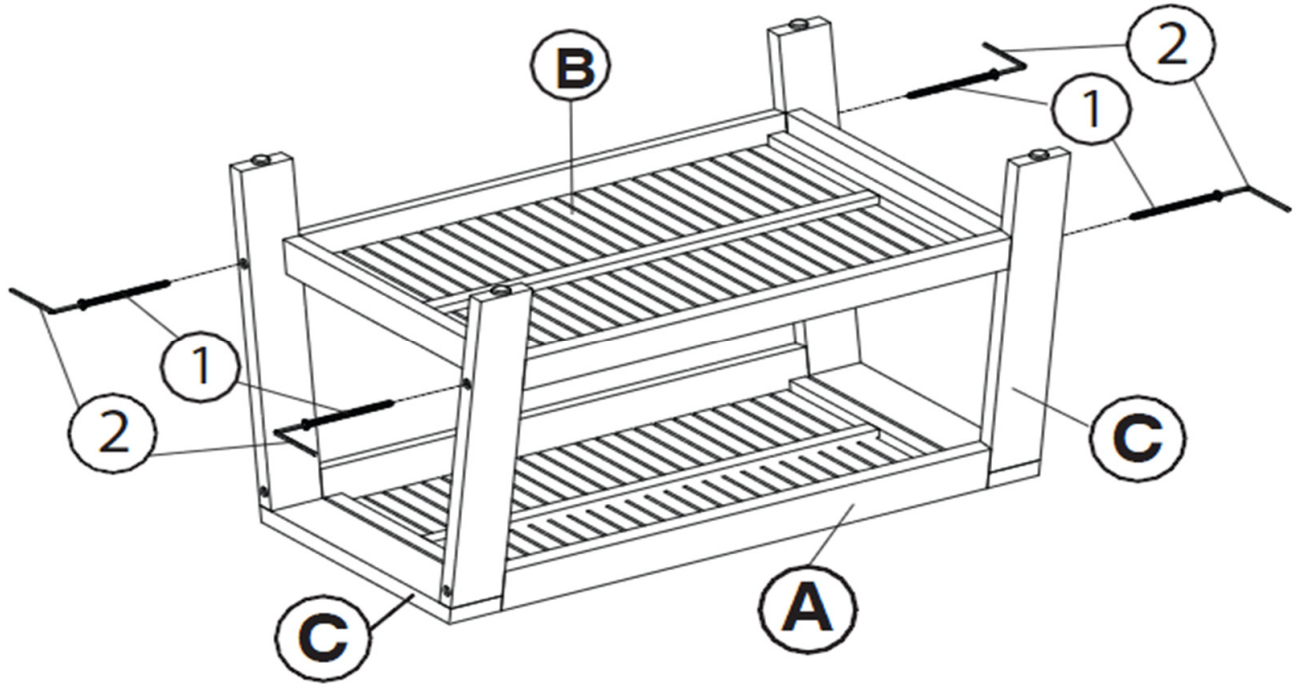

Affix Shelf Panel(B) to Leg Panels (C) by using Screws (①) and Allen Key (②).
You may need to push the Leg Panels (C) outwards slightly to attach the legs.

**CAUTION: When tightening these screws, tighten sequentially.
DO NOT tighten any screw fully and then towards the next one.
This would cause the frame to warp.**



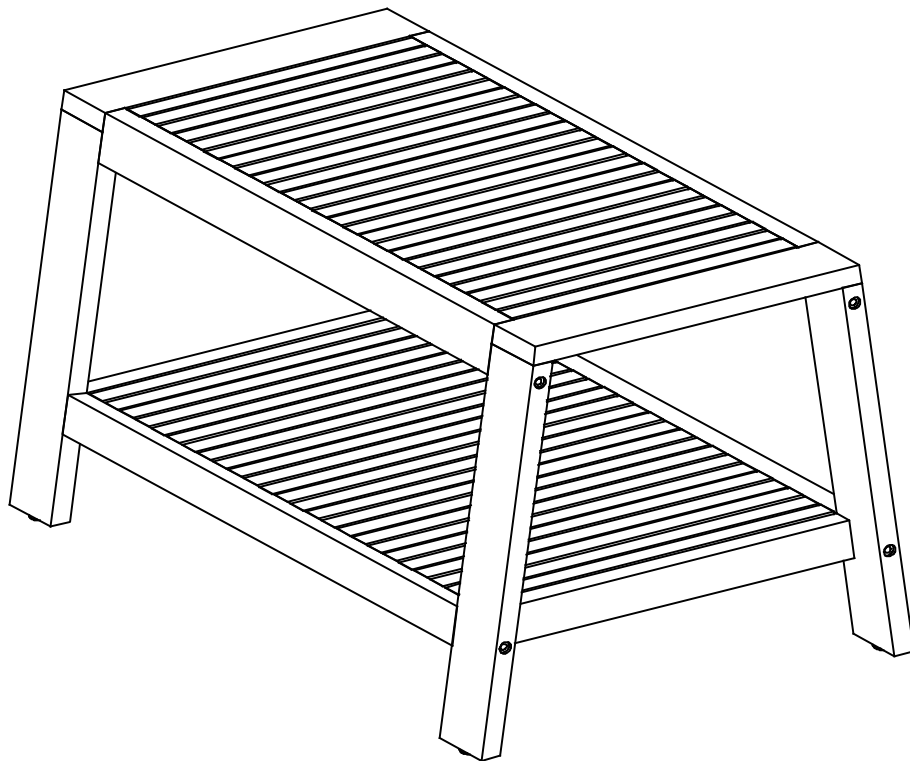















Step 4



Ensure all screws are fully locked into position.
The Table is ready to be used.

Caution: This Table can only be used on a flat, level surface.

Care & Maintenance

-   ● Do not put hot items directly on furniture surface
 -   ● Do not clean furniture with harsh cleansers or polish.
 -   ● To obtain the longest life span of your outdoor products, minimizing exposure to direct sunlight is recommended.
 -   ● Children should not climb or jump on the furniture.
 -   ● Do not write on furniture without a padded barrier to protect the surface.
 -   ● To obtain the longest lifespan of your outdoor products, avoid extended and lengthy exposure to rain, snow, and direct sunshine. Whenever possible cover the product and /or place under patio or awnings.
 -   ● Not for commercial use. For residential use only .
 -   ● Stains may be removed with mild soap solution and damp cloth.
-
-   ● Dust and pick -up spills using a clean, non -colored, lint -free cloth .