

ASSEMBLY INSTRUCTION

INSTRUCTIONS DE MONTAGE

Shuttle 3 door 2 drawer wardrobe-D01

Armoire Shuttle 3 portes 2 tiroirs-D01

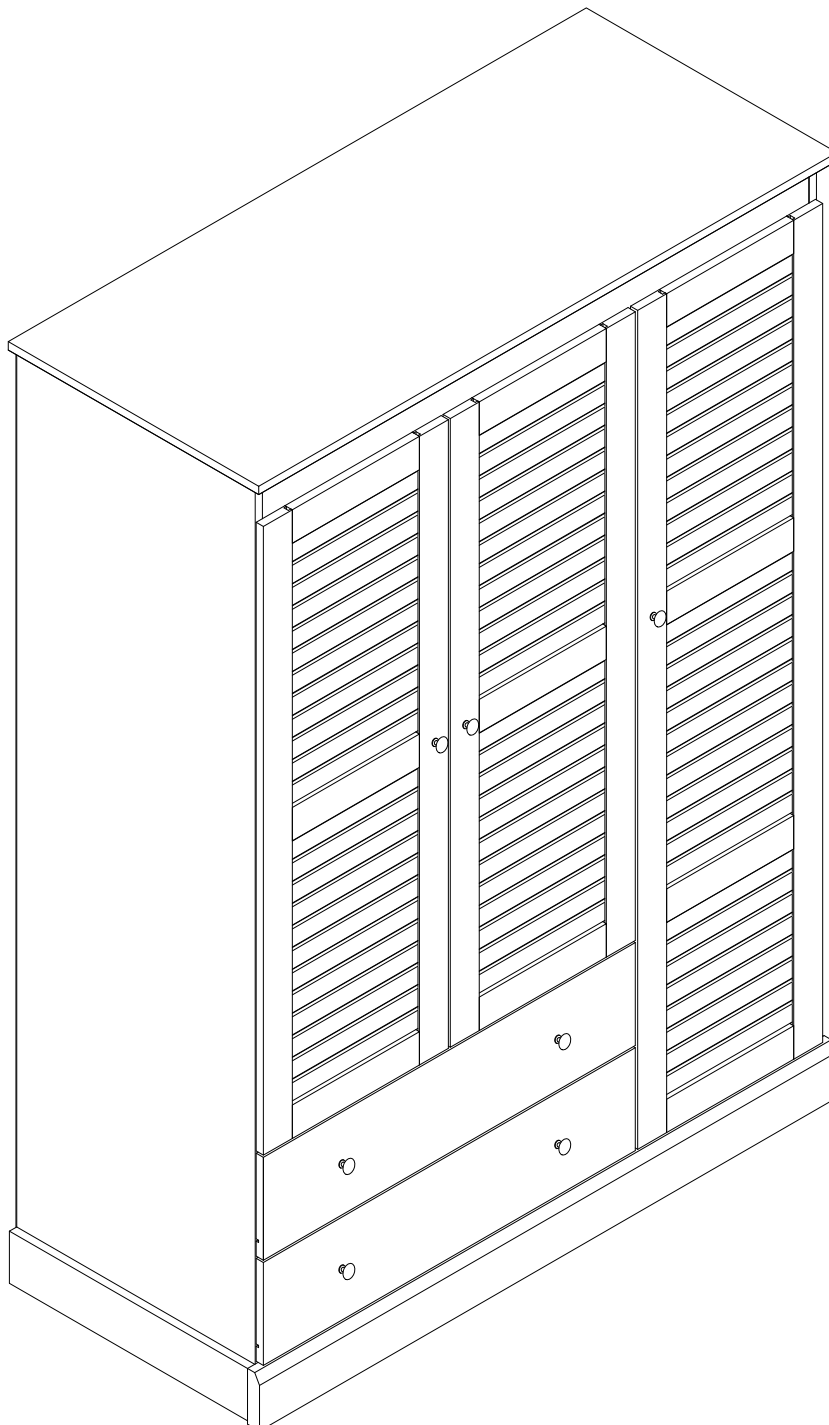

ASSEMBLY INSTRUCTION

INSTRUCTIONS DE MONTAGE

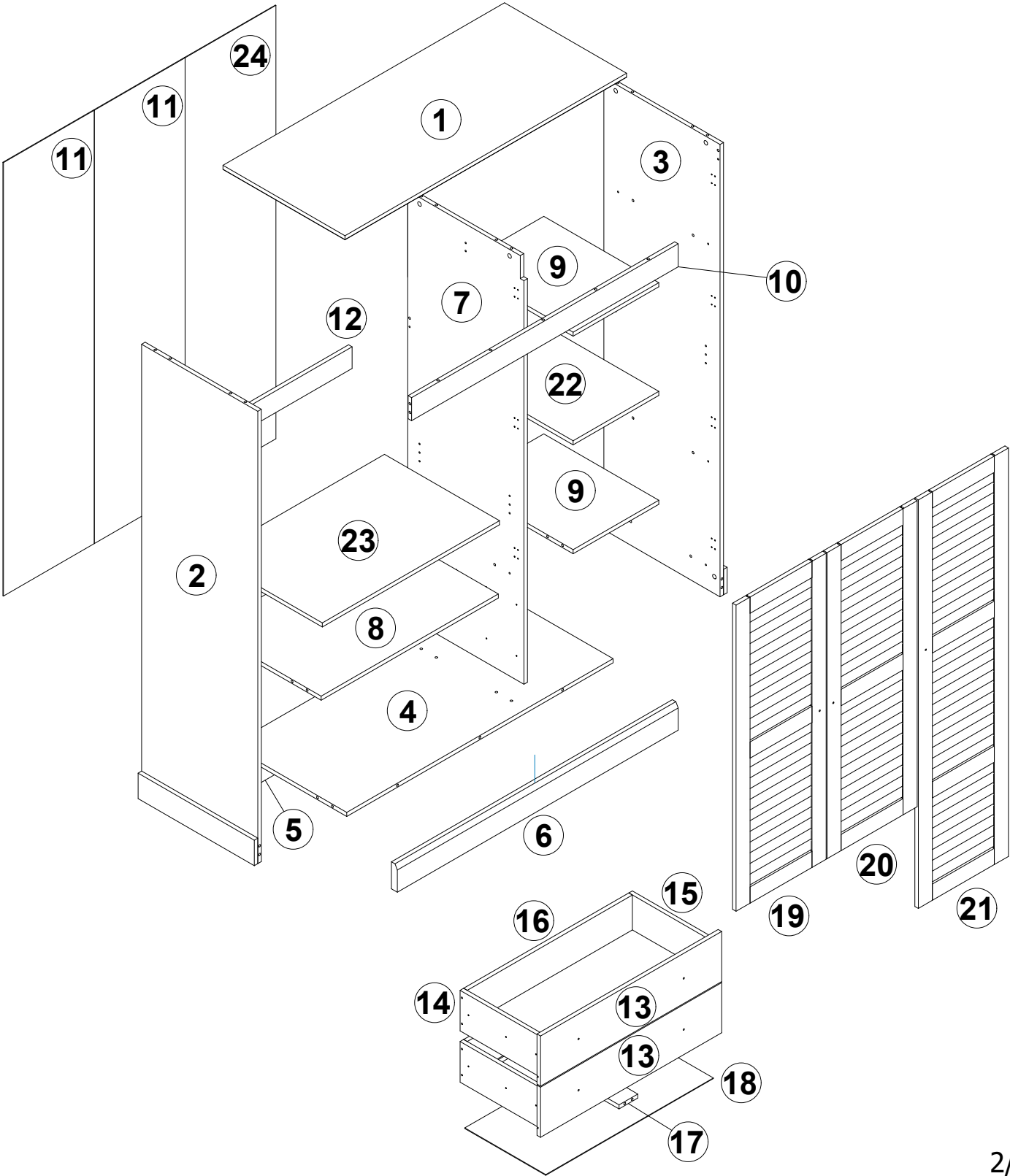

Part List & Hardware List

Liste des pièces et liste du matériel

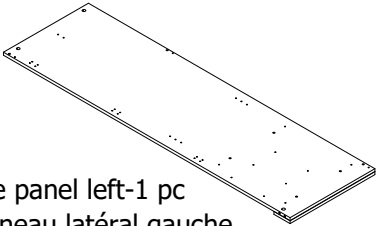
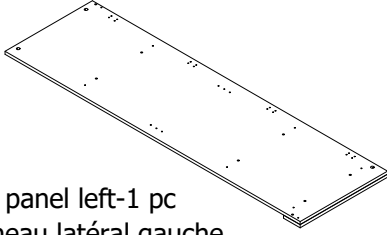
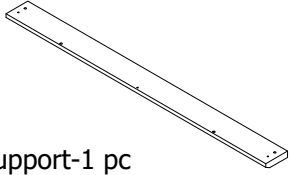
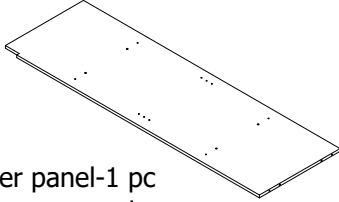
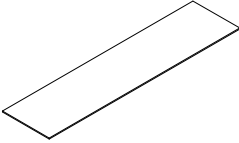
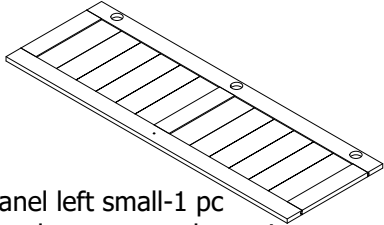
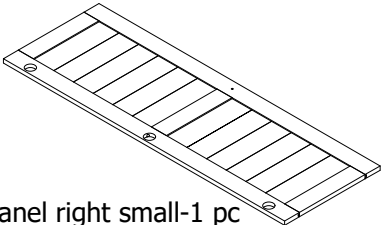
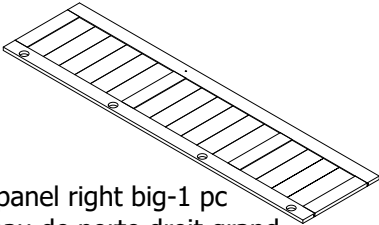
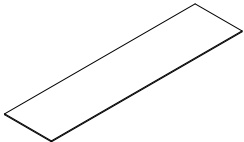
<p>2</p>  <p>Side panel left-1 pc Panneau latéral gauche</p>	<p>3</p>  <p>Side panel left-1 pc Panneau latéral gauche</p>	<p>6</p>  <p>Front support-1 pc Support avant</p>
<p>7</p>  <p>Center panel-1 pc panneau central</p>	<p>11</p>  <p>Back panel-2 pcs Panneau arrière</p>	<p>19</p>  <p>Door panel left small-1 pc Panneau de porte gauche petit</p>
<p>20</p>  <p>Door panel right small-1 pc Panneau de porte droit petit</p>	<p>21</p>  <p>Door panel right big-1 pc Panneau de porte droit grand</p>	<p>24</p>  <p>Back panel-1 pc Panneau arrière</p>





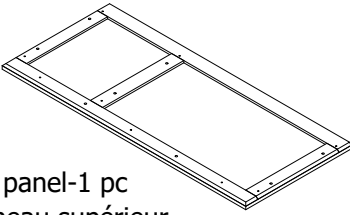
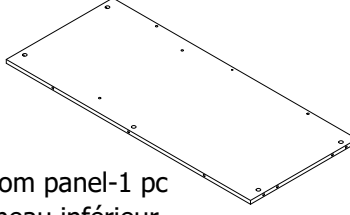
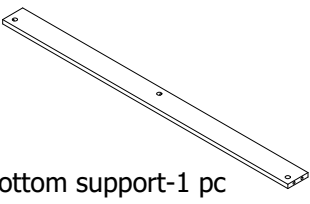
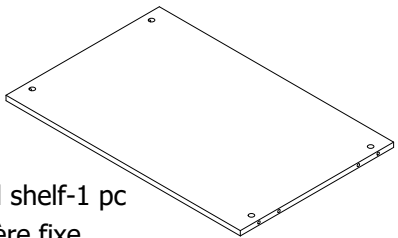
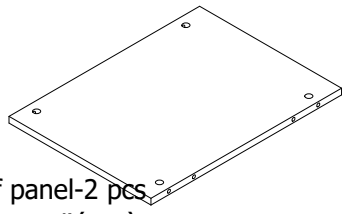
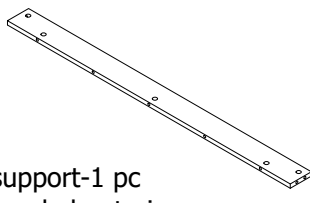
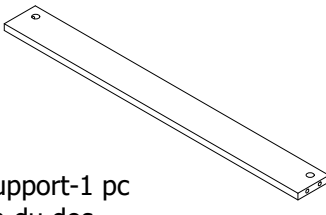
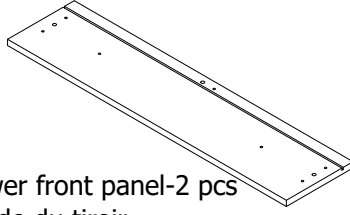
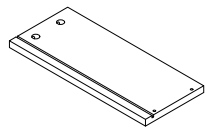
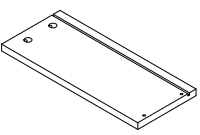
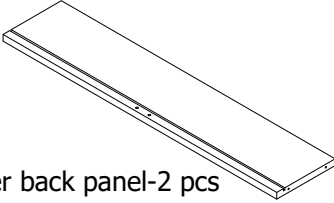
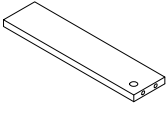
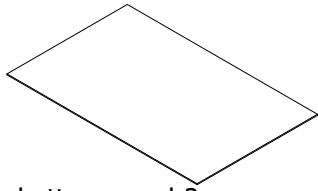
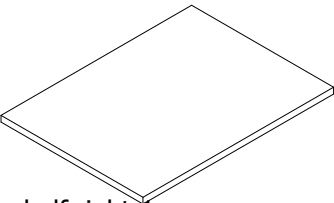
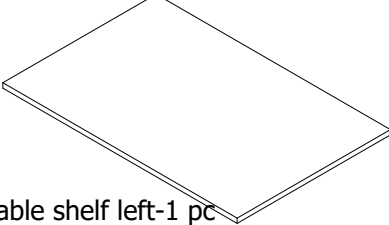





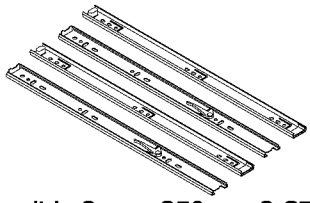
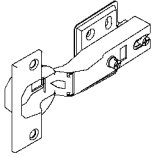
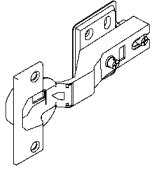
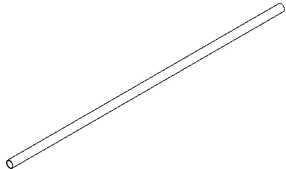
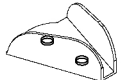
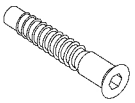

Part List & Hardware List

Liste des pièces et liste du matériel

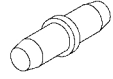
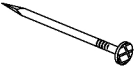
<p>1</p>  <p>Top panel-1 pc Panneau supérieur</p>	<p>4</p>  <p>Bottom panel-1 pc Panneau inférieur</p>	<p>5</p>  <p>Back bottom support-1 pc support du bas du dos</p>
<p>8</p>  <p>Fixed shelf-1 pc Étagère fixe</p>	<p>9</p>  <p>Shelf panel-2 pcs Panneau d'étagère</p>	<p>10</p>  <p>Top support-1 pc Soutien de haut niveau</p>
<p>12</p>  <p>Back support-1 pc Soutien du dos</p>	<p>13</p>  <p>Drawer front panel-2 pcs Façade du tiroir</p>	<p>14</p>  <p>Drawer side panel left-2 pcs Panneau latéral du tiroir à gauche</p>
<p>15</p>  <p>Drawer side panel right-2 pcs Panneau latéral de tiroir droit</p>	<p>16</p>  <p>Drawer back panel-2 pcs Panneau arrière du tiroir</p>	<p>17</p>  <p>Drawer bottom support-2 pcs Support de fond de tiroir</p>
<p>18</p>  <p>Drawer bottom panel-2 pcs Panneau inférieur du tiroir</p>	<p>22</p>  <p>Adjustable shelf right-1 pc Tablette réglable à droite</p>	<p>23</p>  <p>Adjustable shelf left-1 pc Tablette réglable à gauche</p>

Hardware List

Liste du matériel

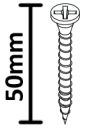
<p>A</p>  <p>Wood dowel Ø8 x 30-44 pcs Cheville en bois</p>	<p>B</p>  <p>Housing Ø 15mm x 13.5mm-45 pcs Boîtier</p>	<p>C</p>  <p>Minifix bolt 24 mm-45 pcs Boulon Minifix</p>			
<p>D</p>  <p>CSK Screw 3.5 X 14-88PCS VIS CSK</p>	<p>E</p>  <p>CSK Screw 4 X 38-12 PCS VIS CSK</p>	<p>F</p>  <p>Drawer slide 2 way 350mm-2 SET/4 pcs Glissière de tiroir</p>			
<p>G</p>  <p>Hinges 5/8" soft closing-7 pcs Charnières 7/8" à fermeture douce</p>	<p>H</p>  <p>Hinges 2/8" soft closing-3 pcs Charnières 2/8" à fermeture douce</p>	<p>I</p>  <p>Pipe aluminium 750 mm-1 pc tube en aluminium</p>			
<p>J</p>  <p>Rail end support-2 pcs support d'extrémité de rail</p>	<p>K</p>  <p>Unita screw 6 x 40-2 pcs Vis Unita</p>	<p>L</p>  <p>Allen key m4-1 pc clé Allen</p>			
<p>M</p>  <p>Shelf support 5 X 16 -8 pcs Support d'étagère</p>	<p>N</p>  <p>STEEL NAIL 2 X 20MM-45 PCS Clou en acier</p>	<p>O</p>  <p>Handle-7 pcs Poignée</p>			
<p>P</p>  <p>Pan head screw-M4 x 20-7 pcs Vis à tête cylindrique</p>	<p>Q</p>  <p>CSK Screw 4x20 -2PCS VIS CSK</p>	 <p>L-Bracket -2PCS Support d'angle</p>	 <p>Wall Plug -2PCS Chevilles de Fixation</p>	 <p>Washer -2PCS Rondelle</p>	 <p>CSK Screw 4x50 -2PCS VIS CSK</p>

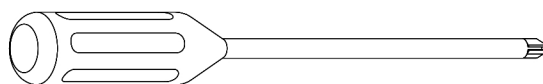

Assembly Tools Required (Not included)
Outils d'assemblage requis (non inclus)

Hardware List

Liste du matériel

I

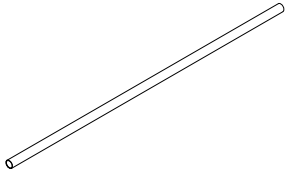

Pipe aluminium 750 mm-1 pc
tube en aluminium

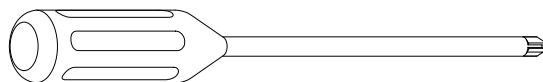

Assembly Tools Required (Not included)
Outils d'assemblage requis (non inclus)

Step 1 :
Étape 1:

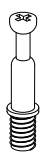
C	
32 pcs	

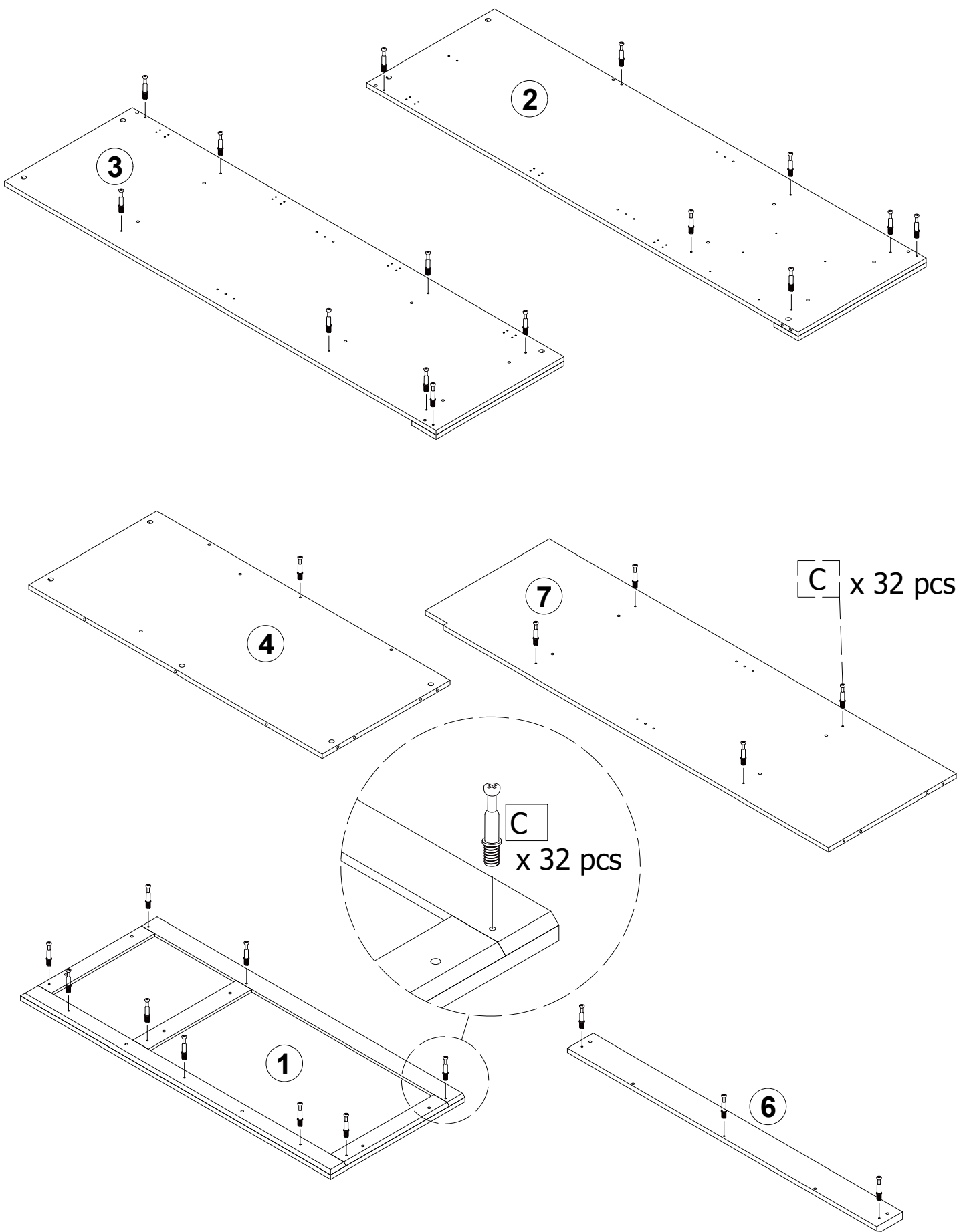

Step 2 :
Étape 2:

A

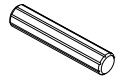

38 pcs

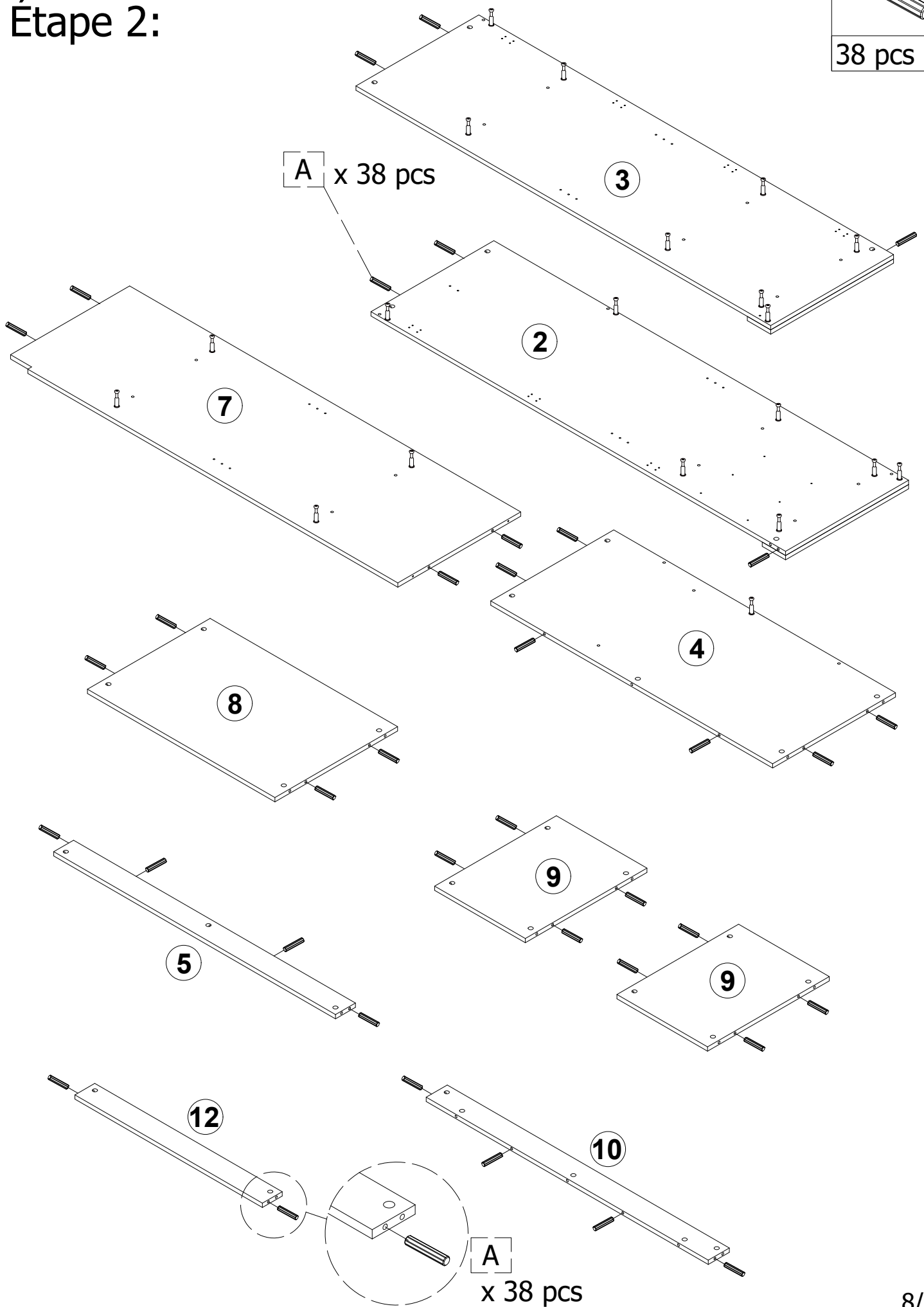

Step 3 :
Étape 3:

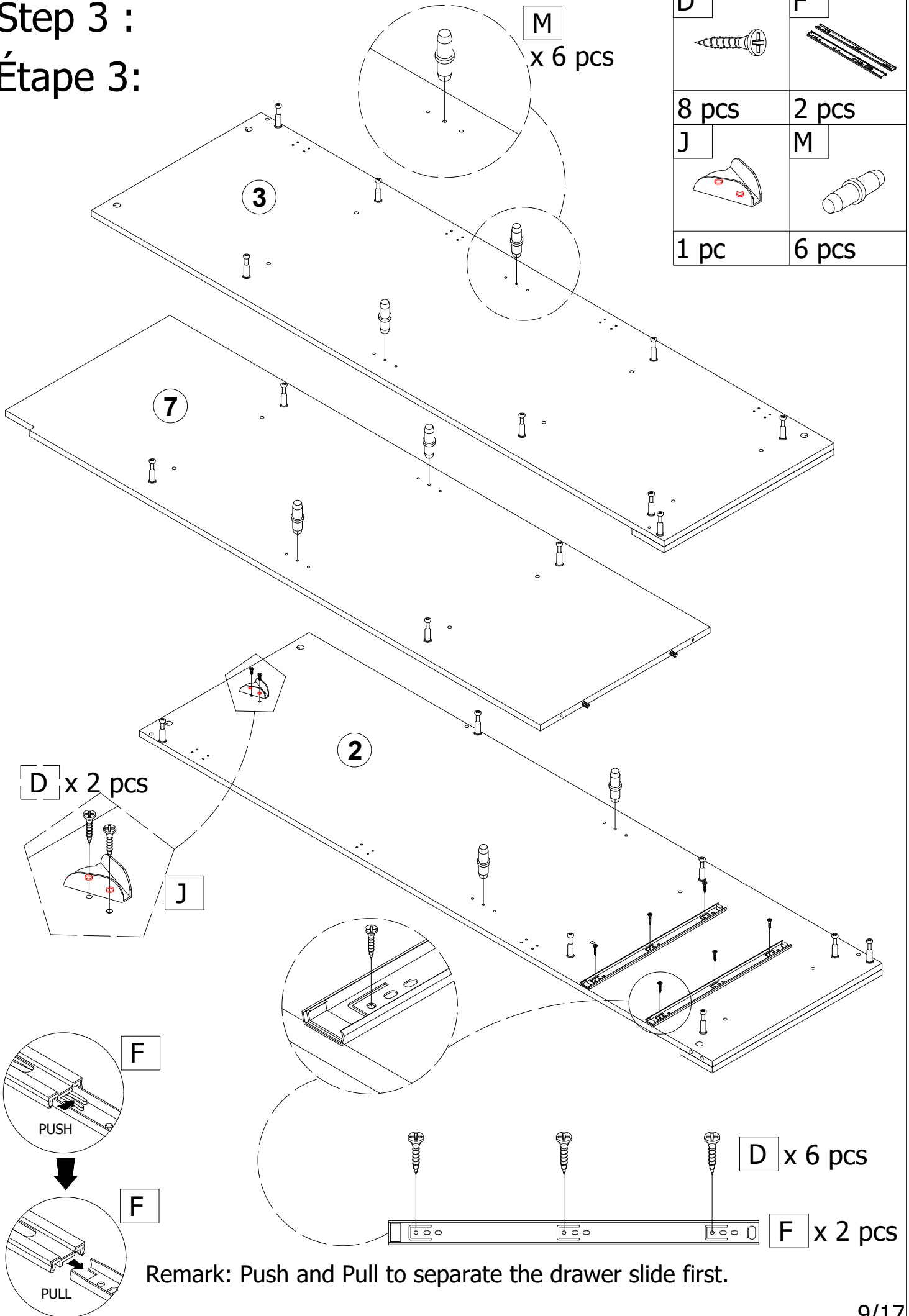

Step 4 :
Étape 4:

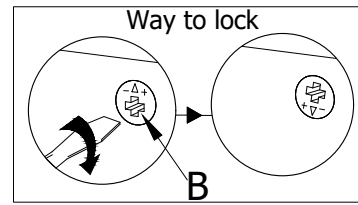

B	
1 pc	

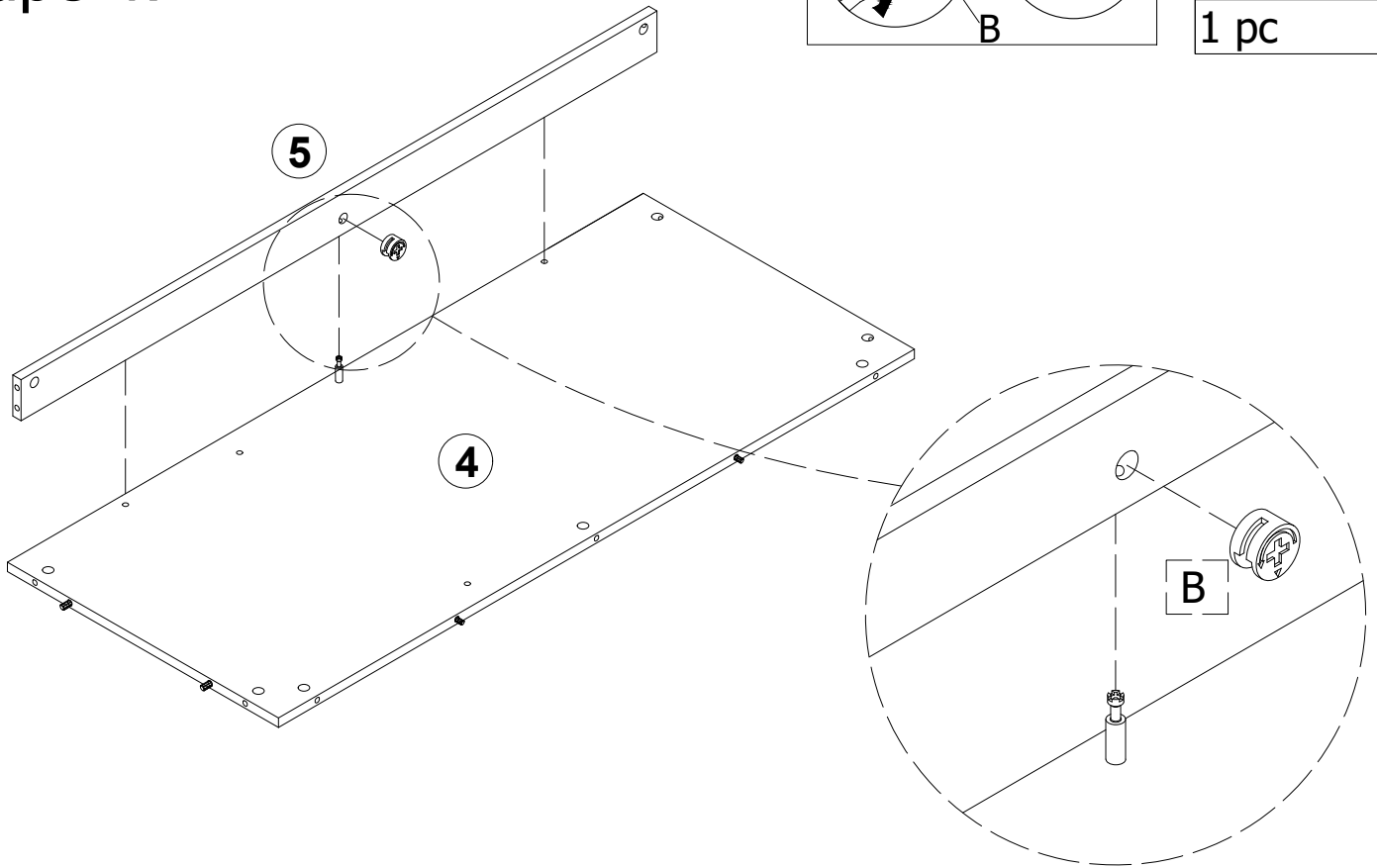

Step 5 :
Étape 5:

C		D		F	
3 pcs		8 pcs		2 pcs	
		J		M	
		1 pc		2 pcs	

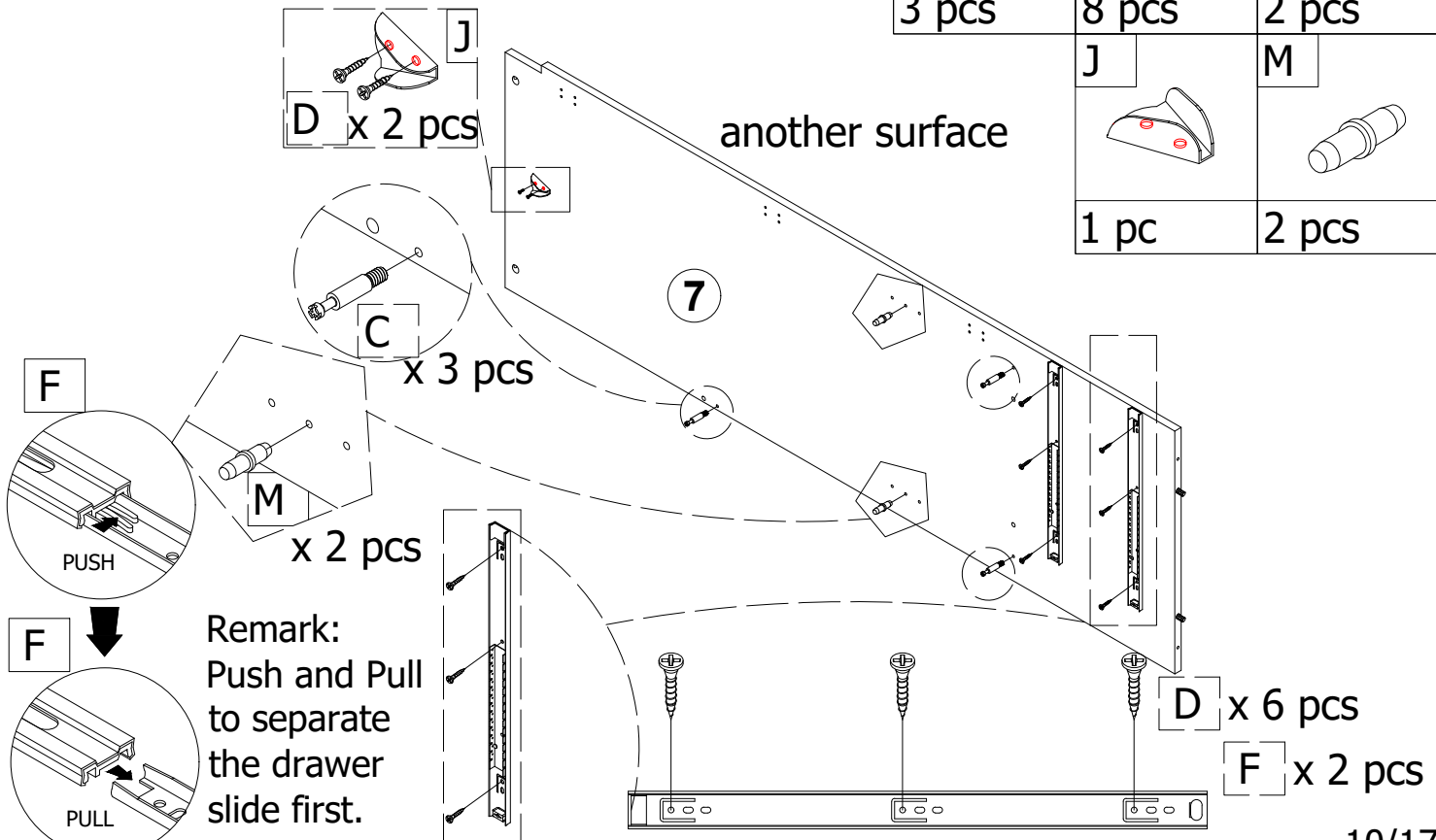

Remark:
Push and Pull
to separate
the drawer
slide first.

Step 6 :
Étape 6:

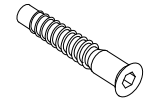
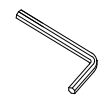
K 	L 
2 pcs	1 pc

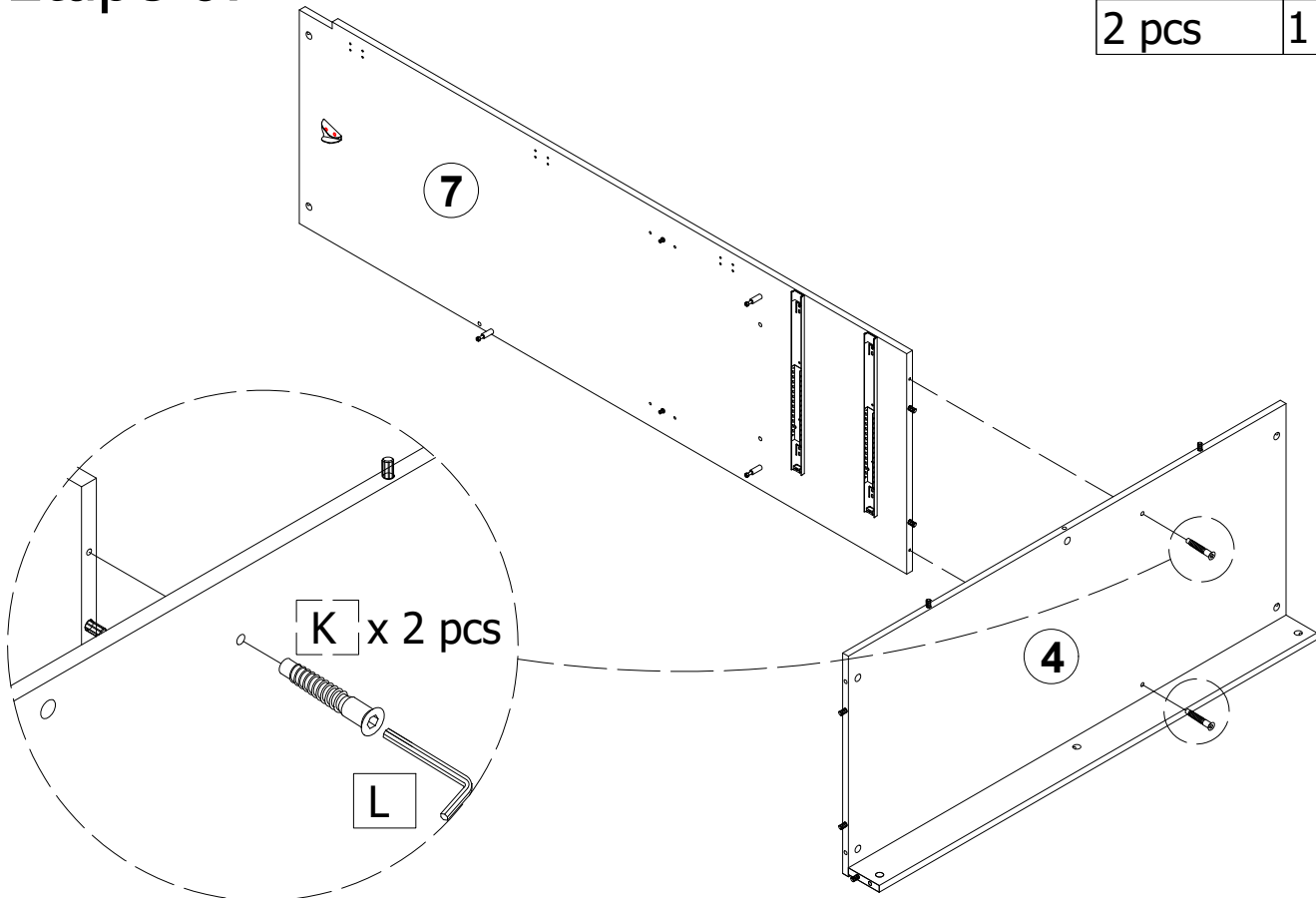

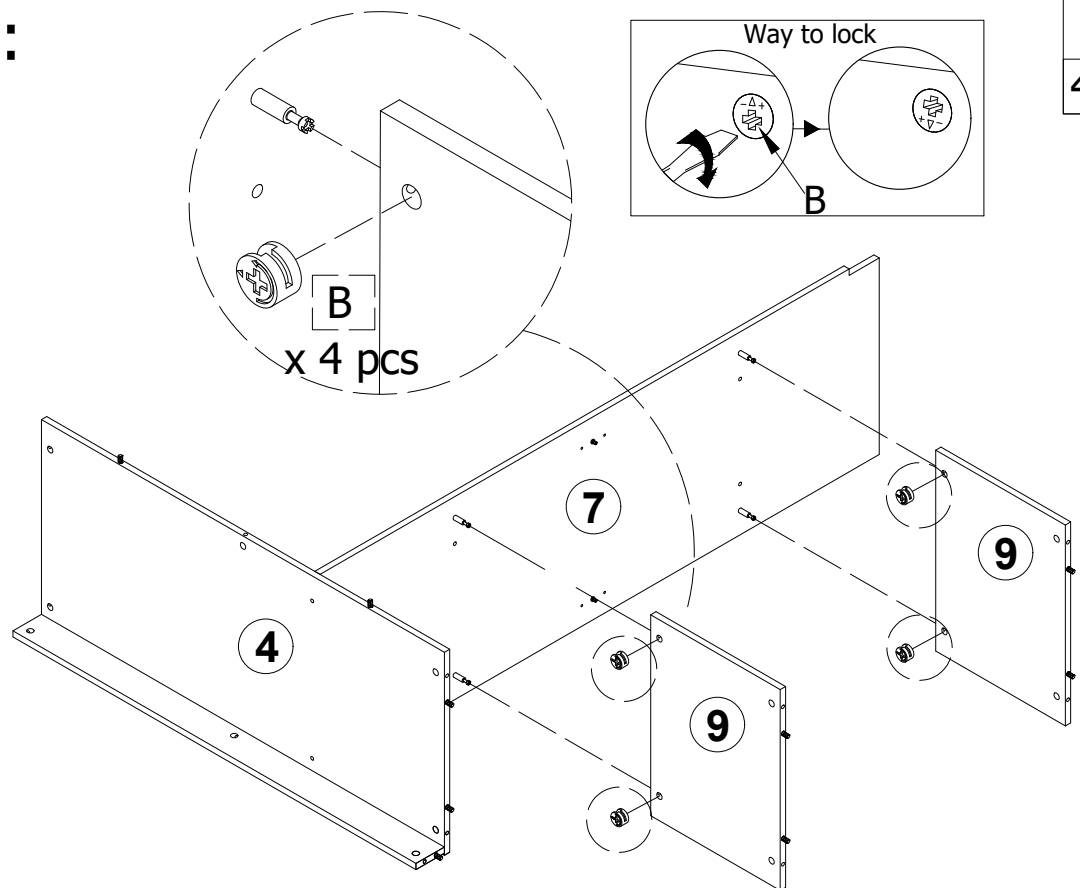

Step 7 :
Étape 7:

B 
4 pcs

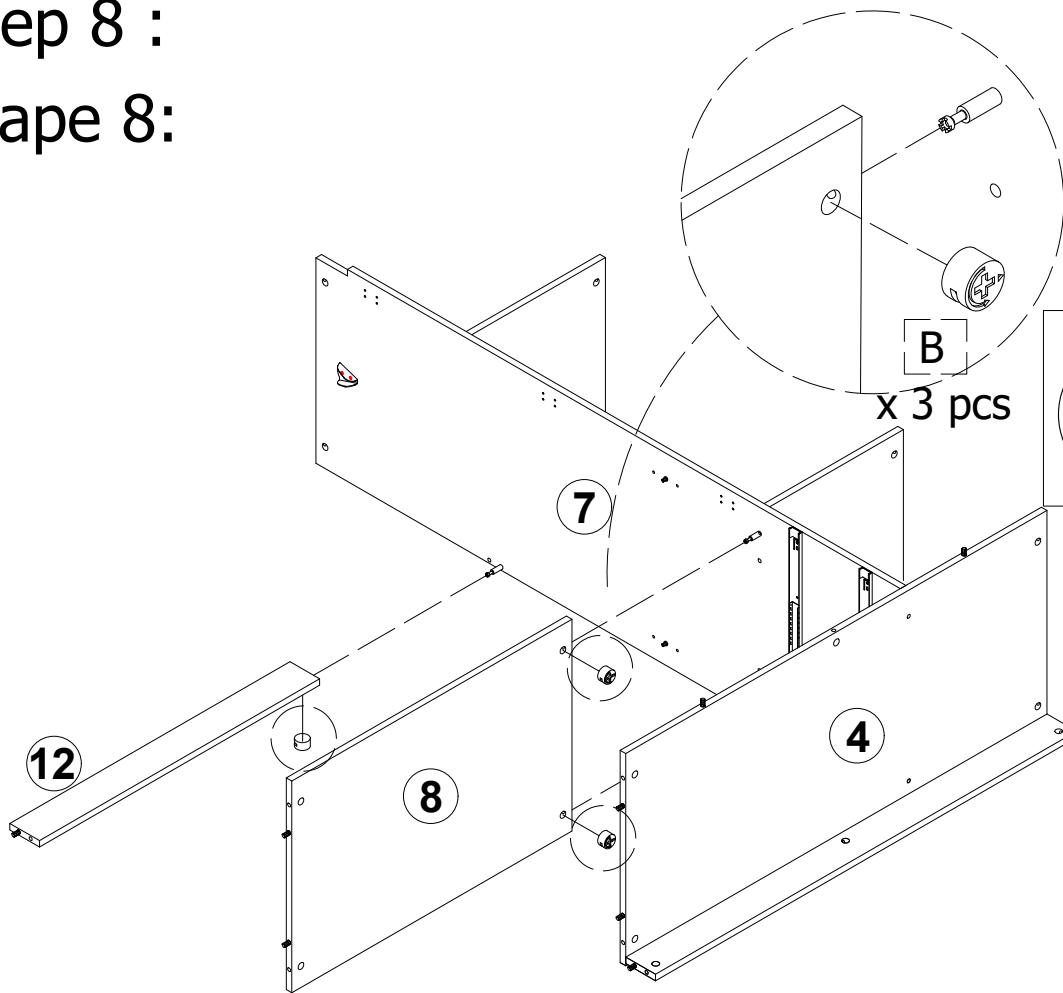

Step 8 :
Étape 8:

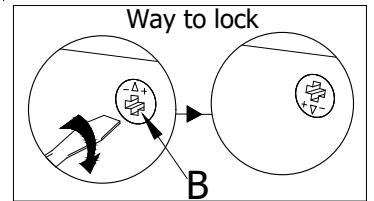

B

3 pcs

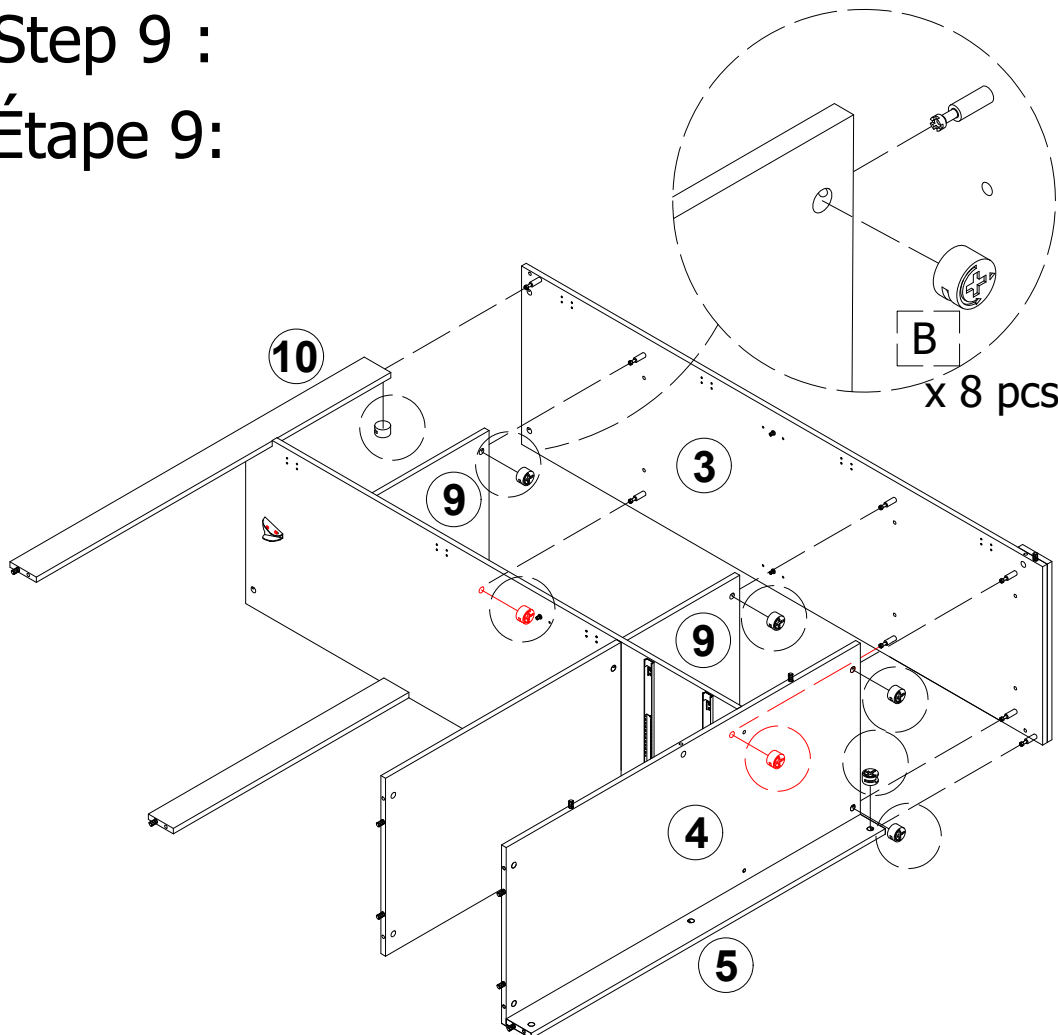

Step 9 :
Étape 9:

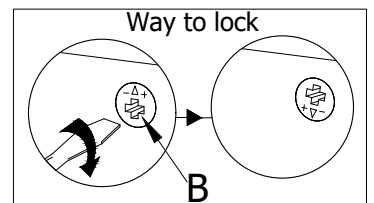

B

8 pcs



Step 10 :
Étape 10:

B



7 pcs

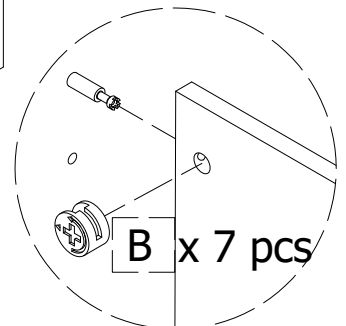
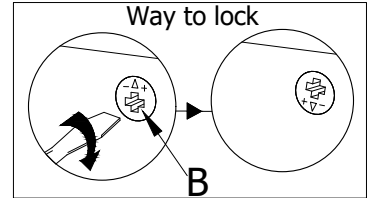
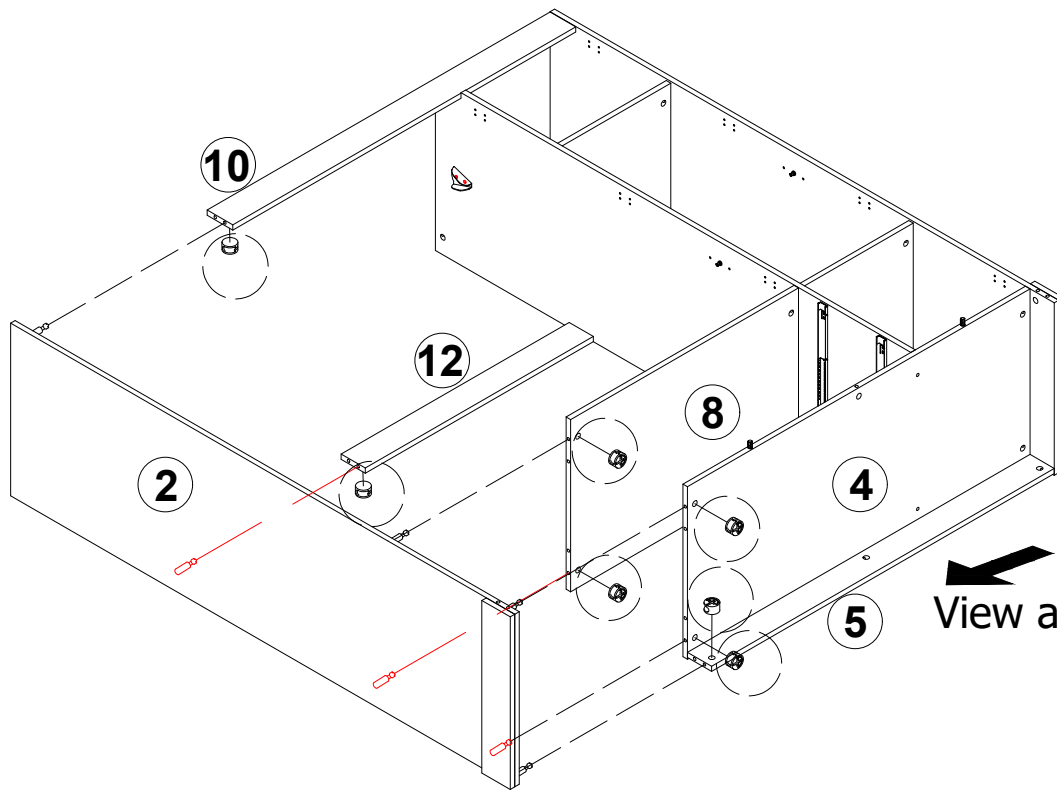

See from View a

Step 11 :
Étape 11:

B



12 pcs

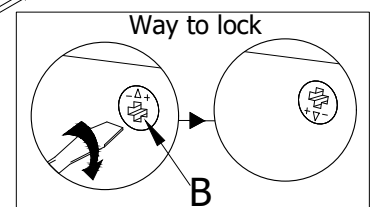
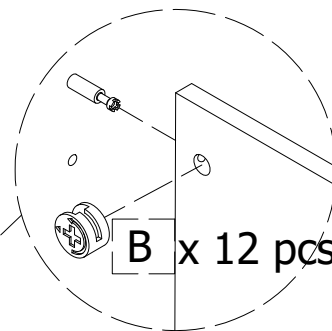
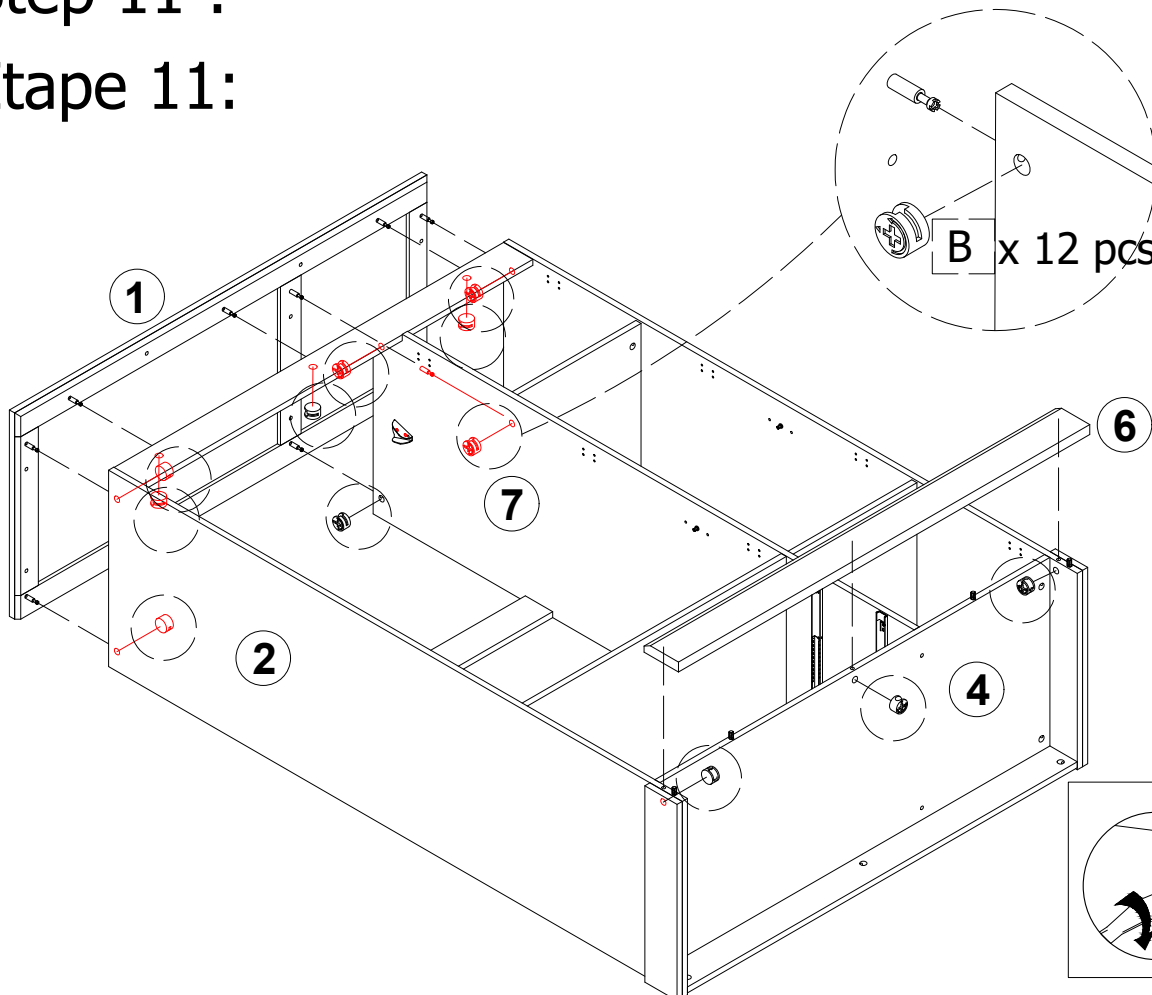

Step 12 :
Étape 12:

N

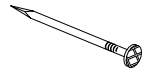

45 pcs

Back view

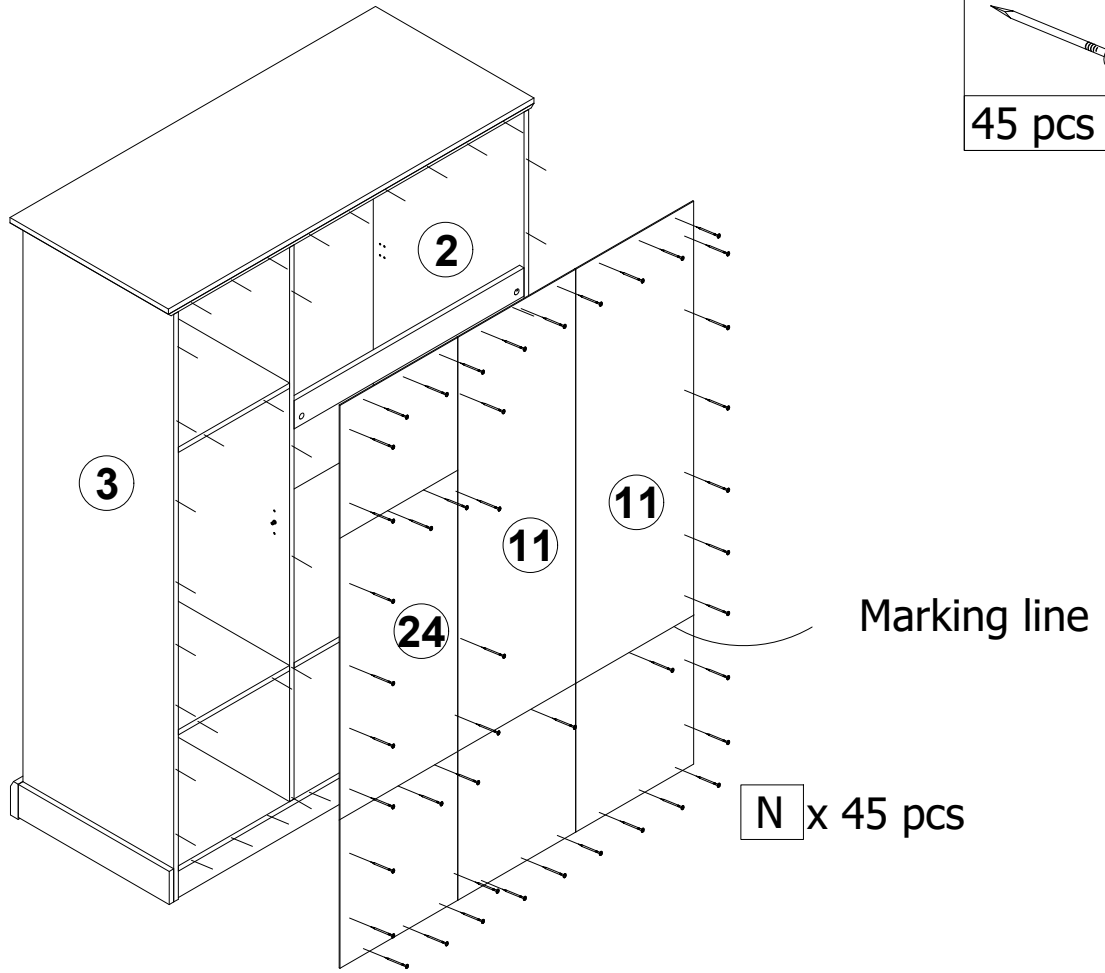

N x 45 pcs

Step 13 :
Étape 13:

another surface
Une autre surface

another surface
Une autre surface

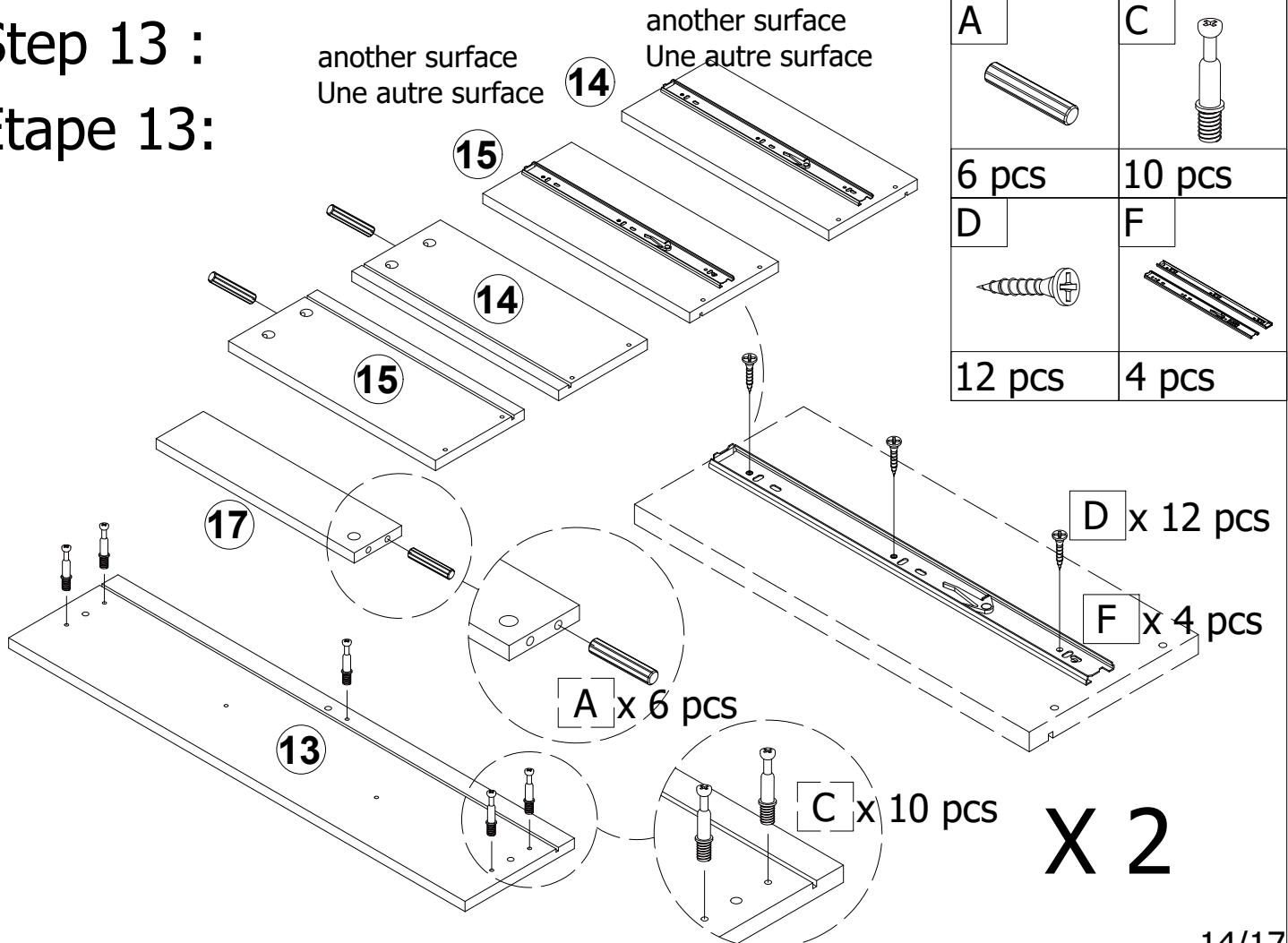

A

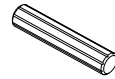

6 pcs

C

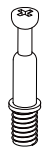

10 pcs

D

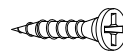

12 pcs

F

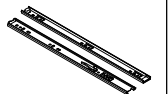

4 pcs

A x 6 pcs

D x 12 pcs

F x 4 pcs

C x 10 pcs

X 2

Step 14 :

Étape 14:

E



12 pcs

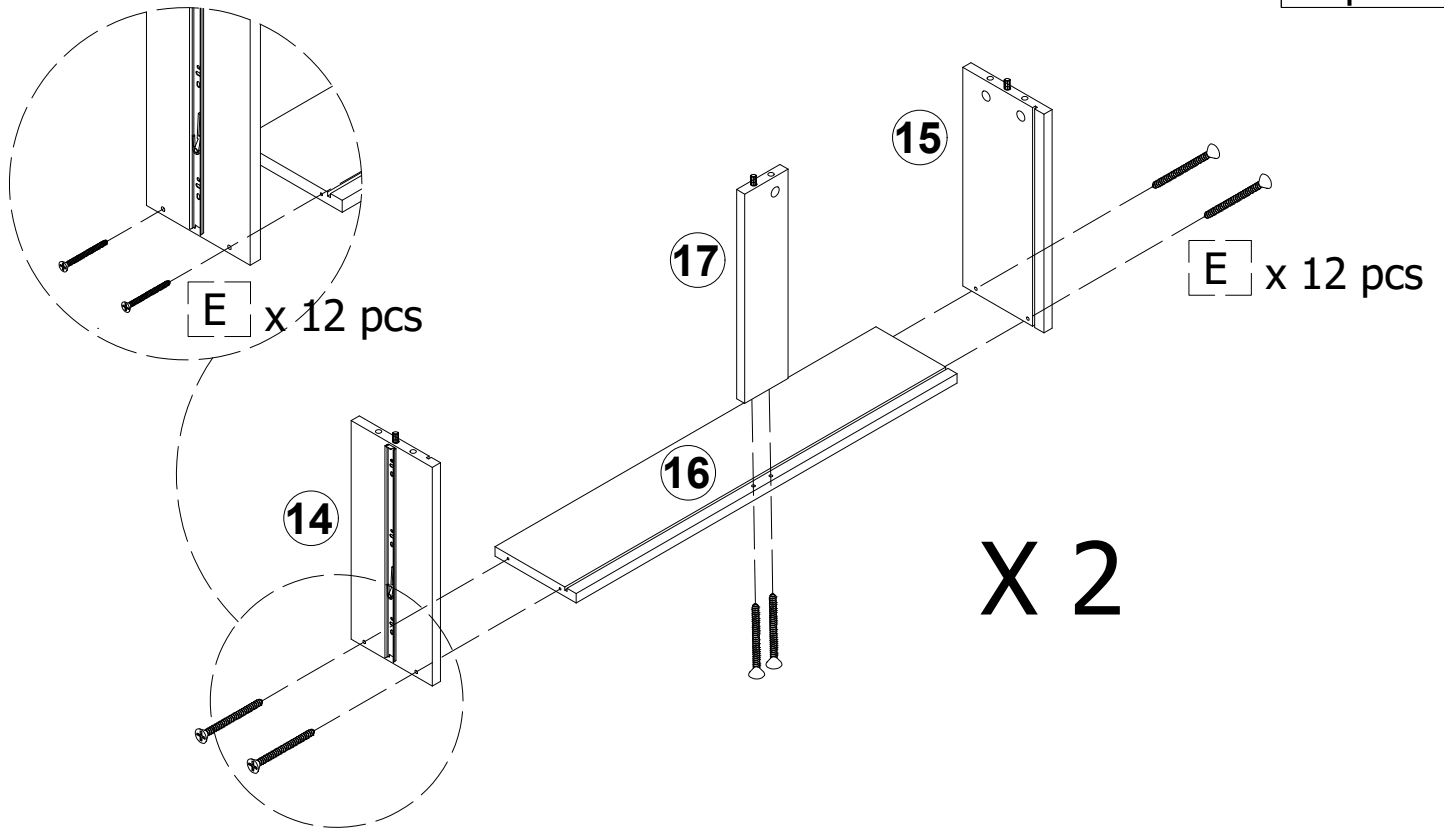

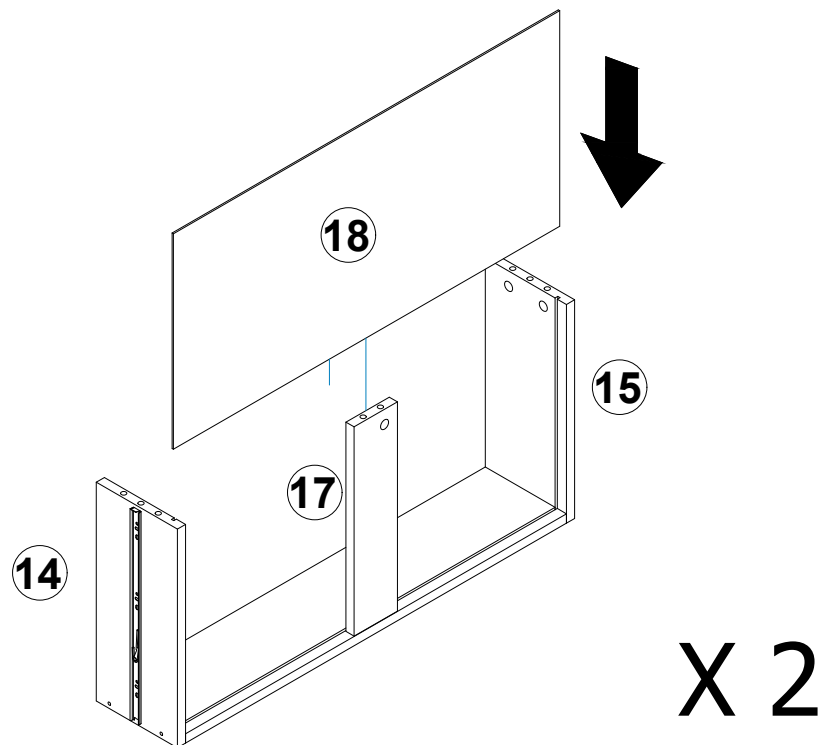

Step 15 :

Étape 15:



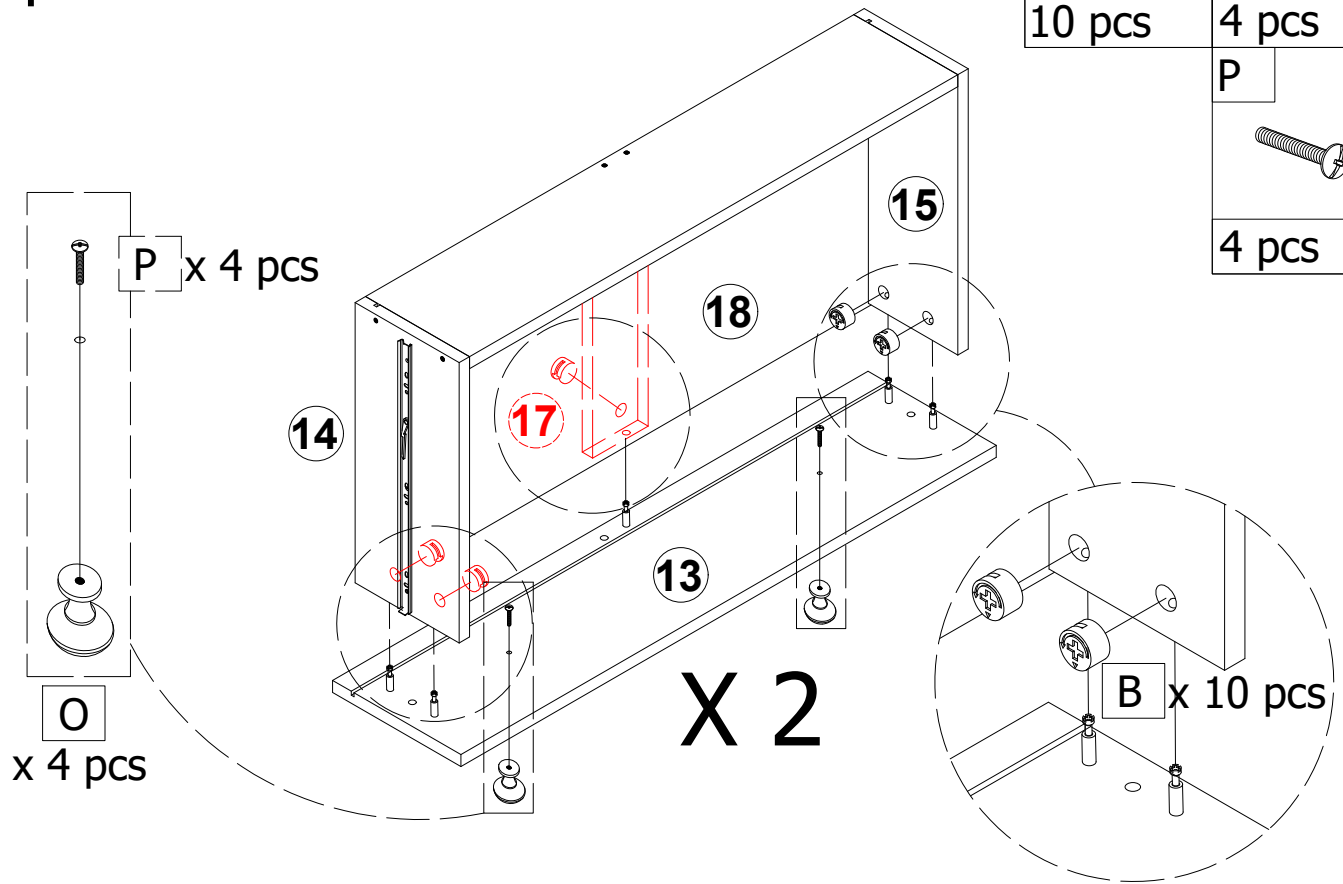

Step 16 :
Étape 16:

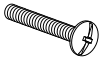

B		O	
10 pcs		4 pcs	
		P	
		4 pcs	

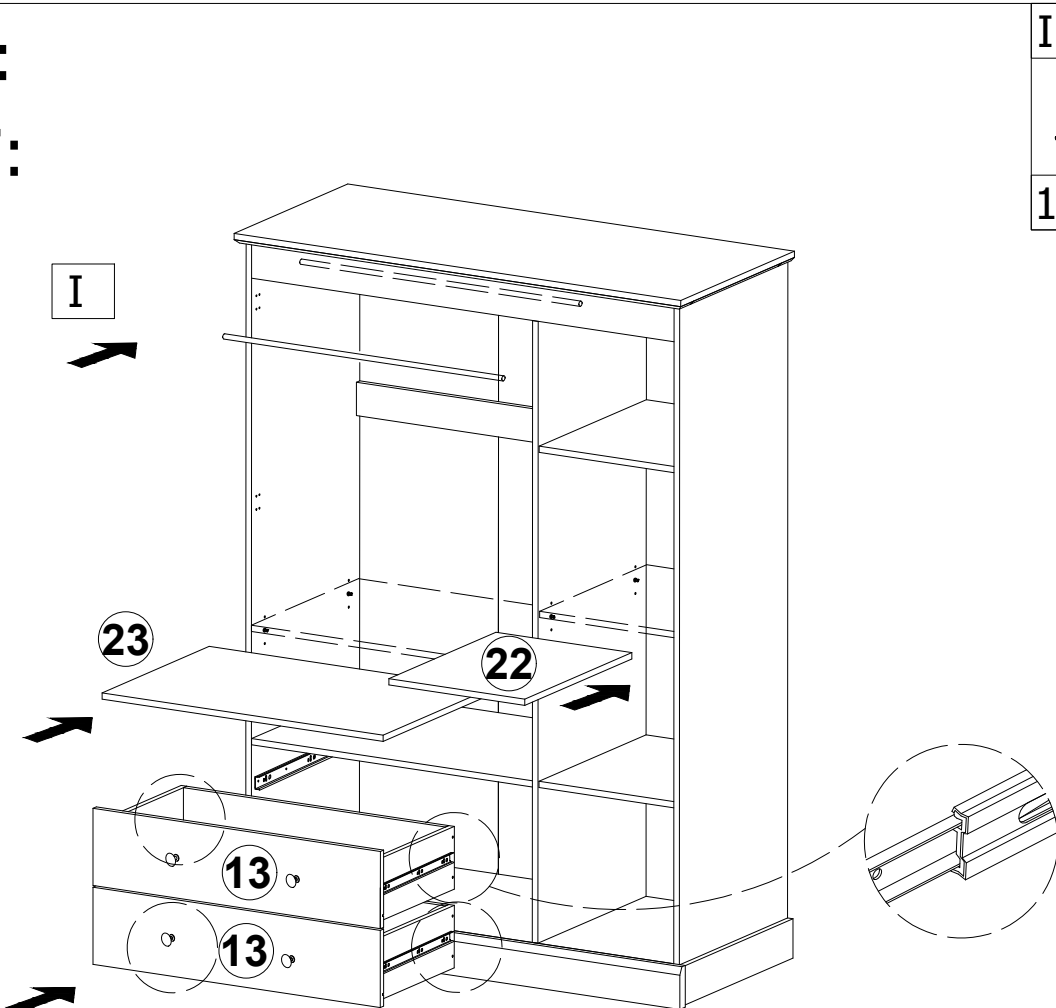

Step 17 :
Étape 17:



I	
1 pc	

Step 18 :

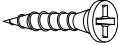
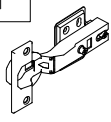
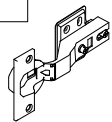
Étape 18:

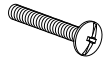
D 	G 	H 
60 pcs	7 pcs	3 pcs
	O 	P 
	3 pcs	3 pcs

