

INSTRUCTION

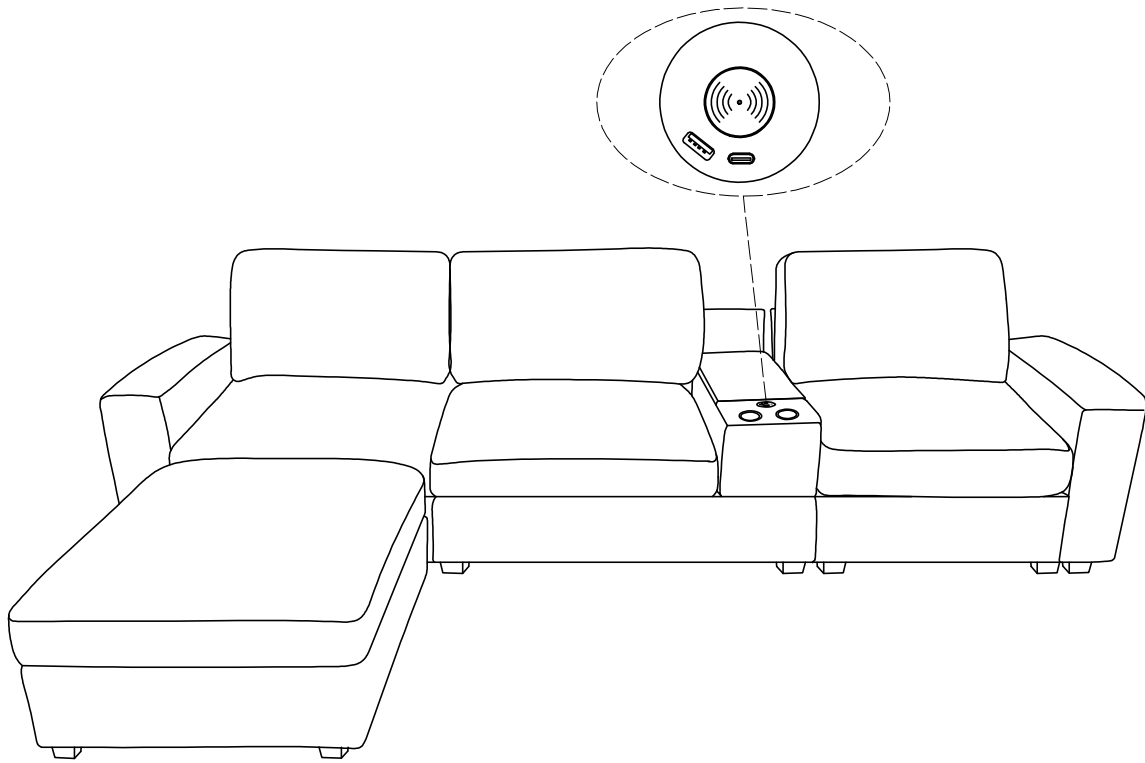

Notice: The resilience performance of this product is affected by the weather. Please do not worry about it when you receive the product. 72 hours are required for the product to resilient. An ironing machine can iron the wrinkles.



PARTS LIST

A x1

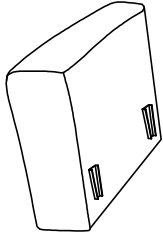

B x1

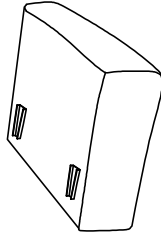

C x2

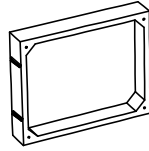

D x1

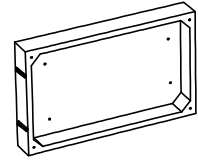

E x2

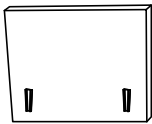

F x1

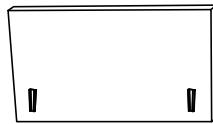

G x2



H x1

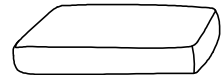

J x2



K x1

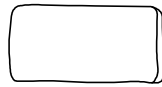

L x1

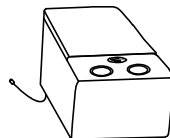

M x1

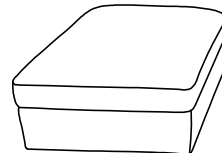

N x2



P x20



Q x2



R x2



S x2



T x1

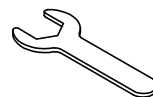

U x1



BOX 1

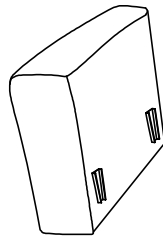
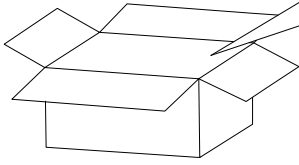

A X1

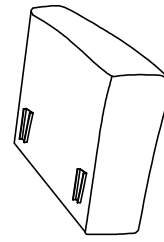

B X1

BOX 2

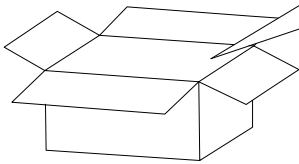

G X2

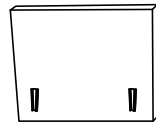

E X2



J X2

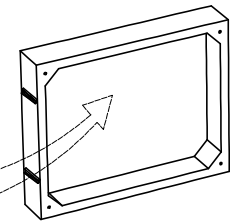

C X2

BOX 3

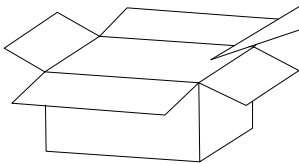

H X1

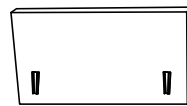

F X1



K X1

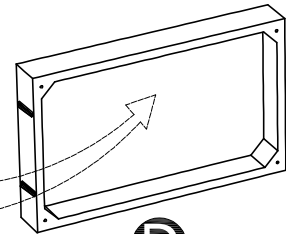

D X1

BOX 4

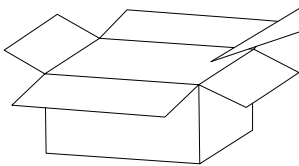

N X2



P X20



R X2



U X1

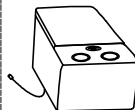

L X1



S X2



T X1



Q X2

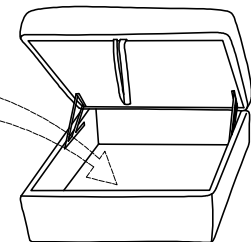

M X1

Step 1

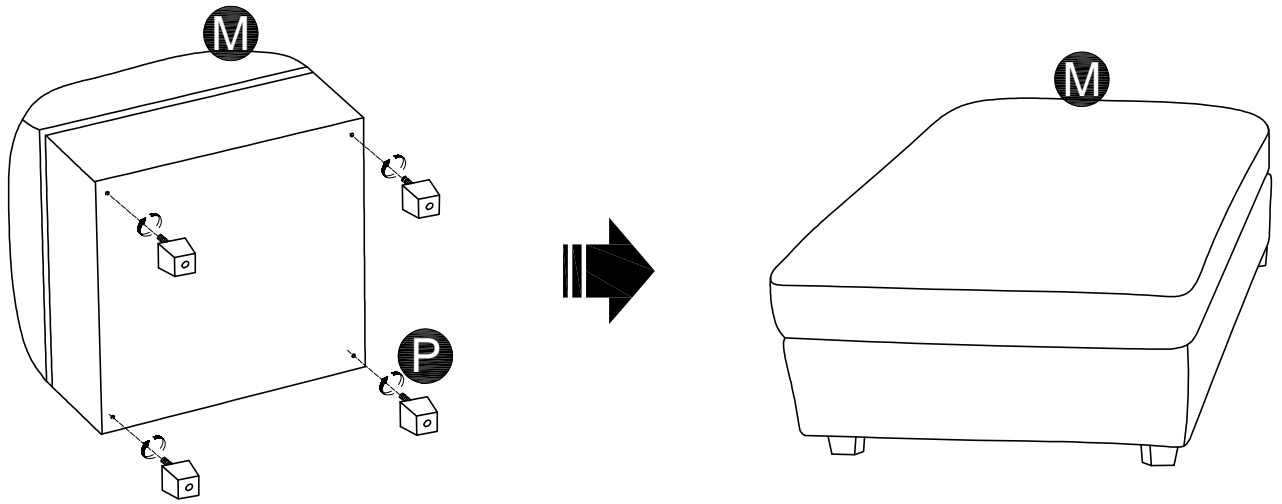

Step 2

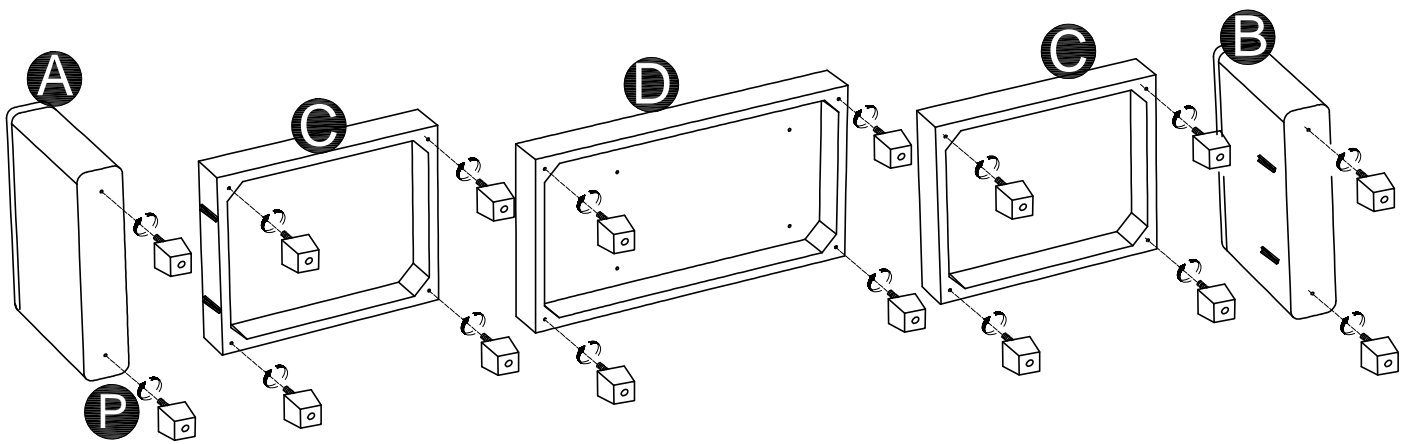

Step 3

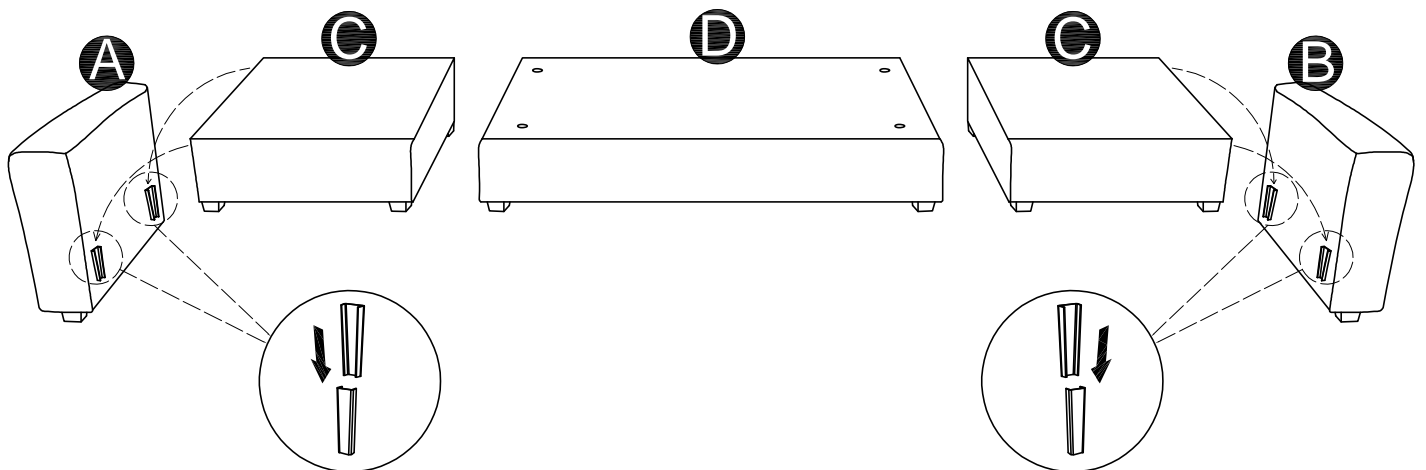

Step 4

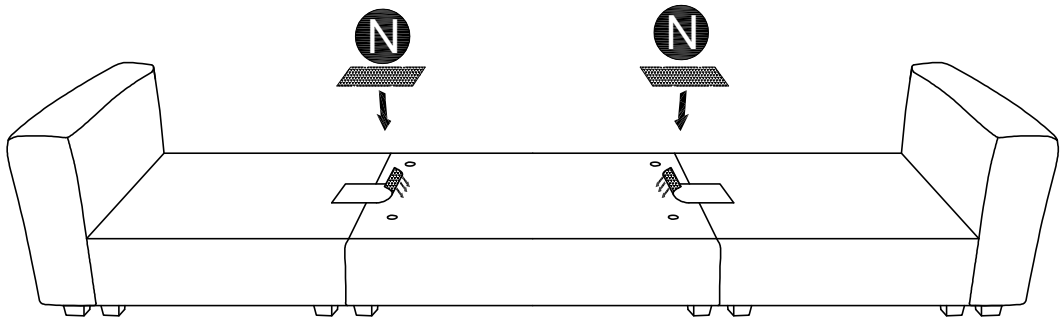

Step 5

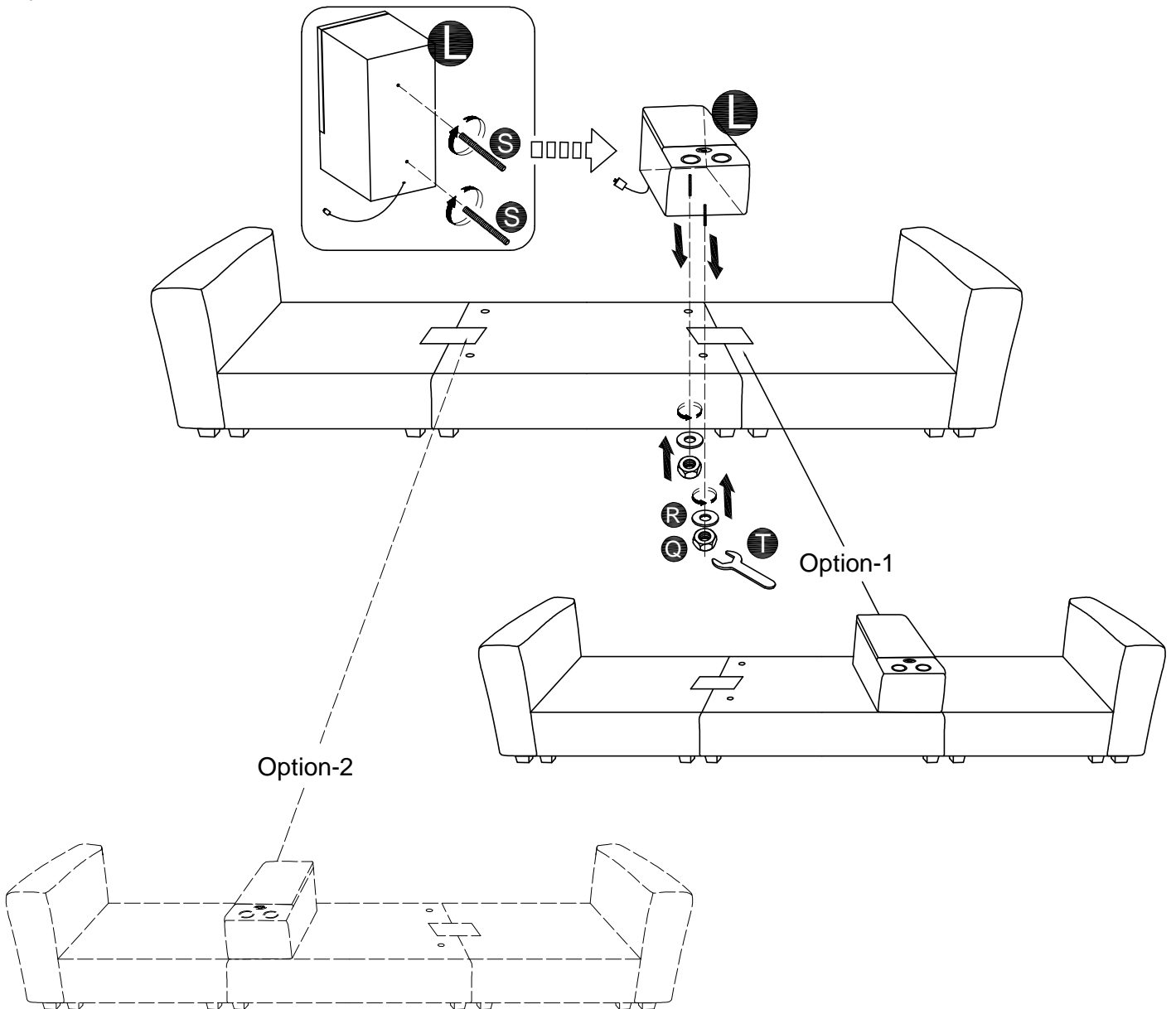

Step 6

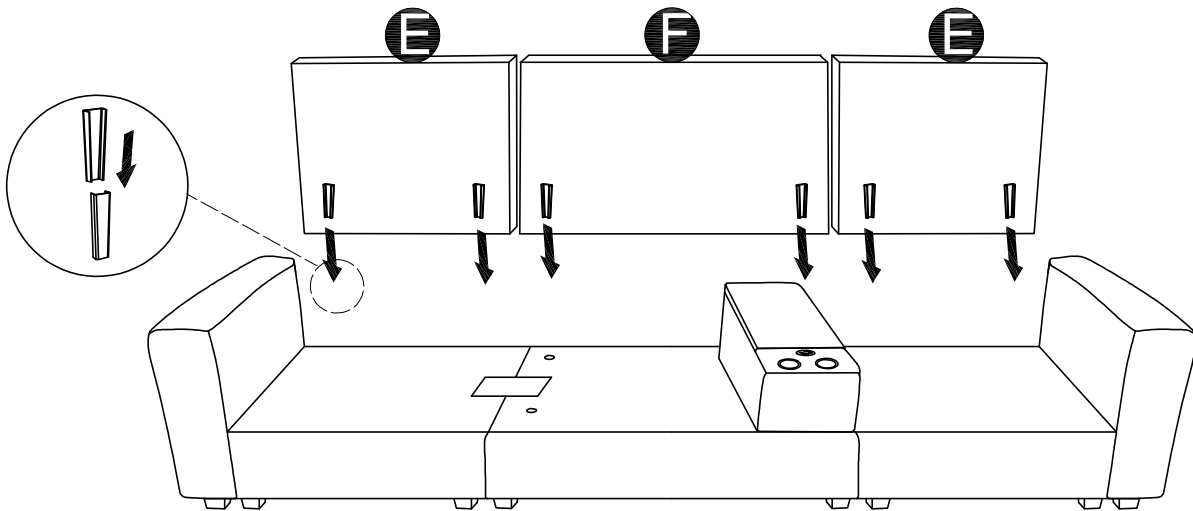

Step 7

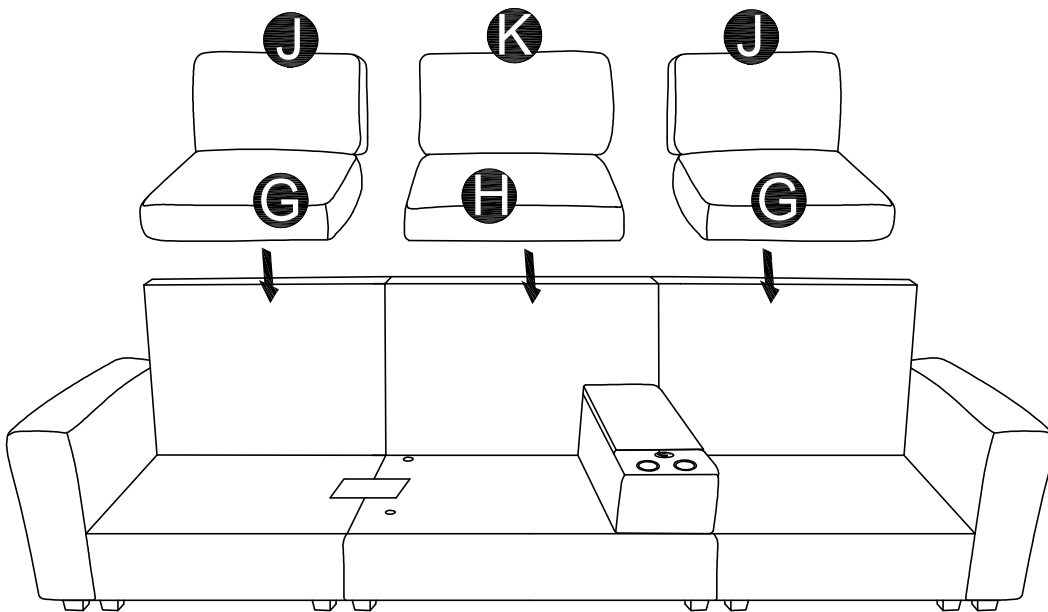

Step 8

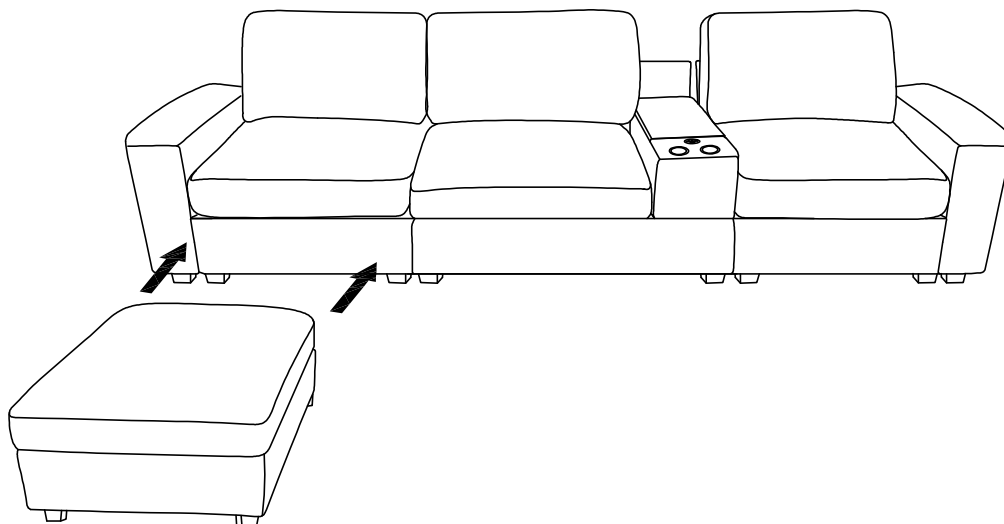

Step 9

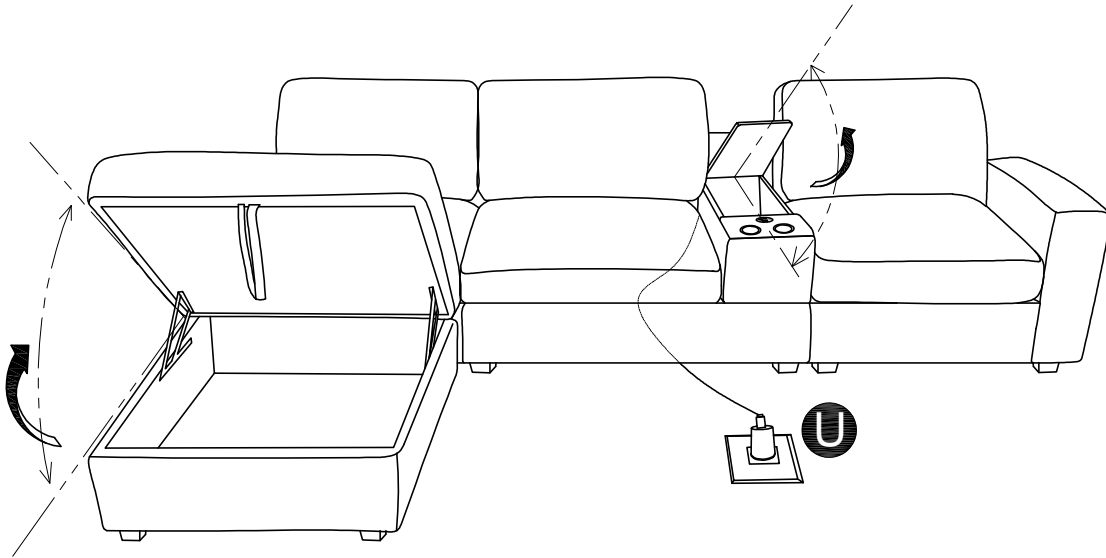

Option-1

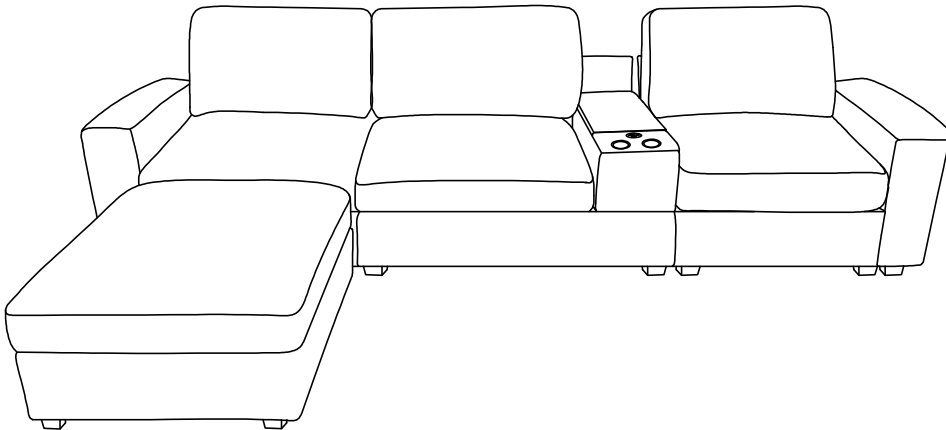

Option-2

