

# ASSEMBLY INSTRUCTION

SKU:WF315909AAE/WF315909AAA/WF315909AAH

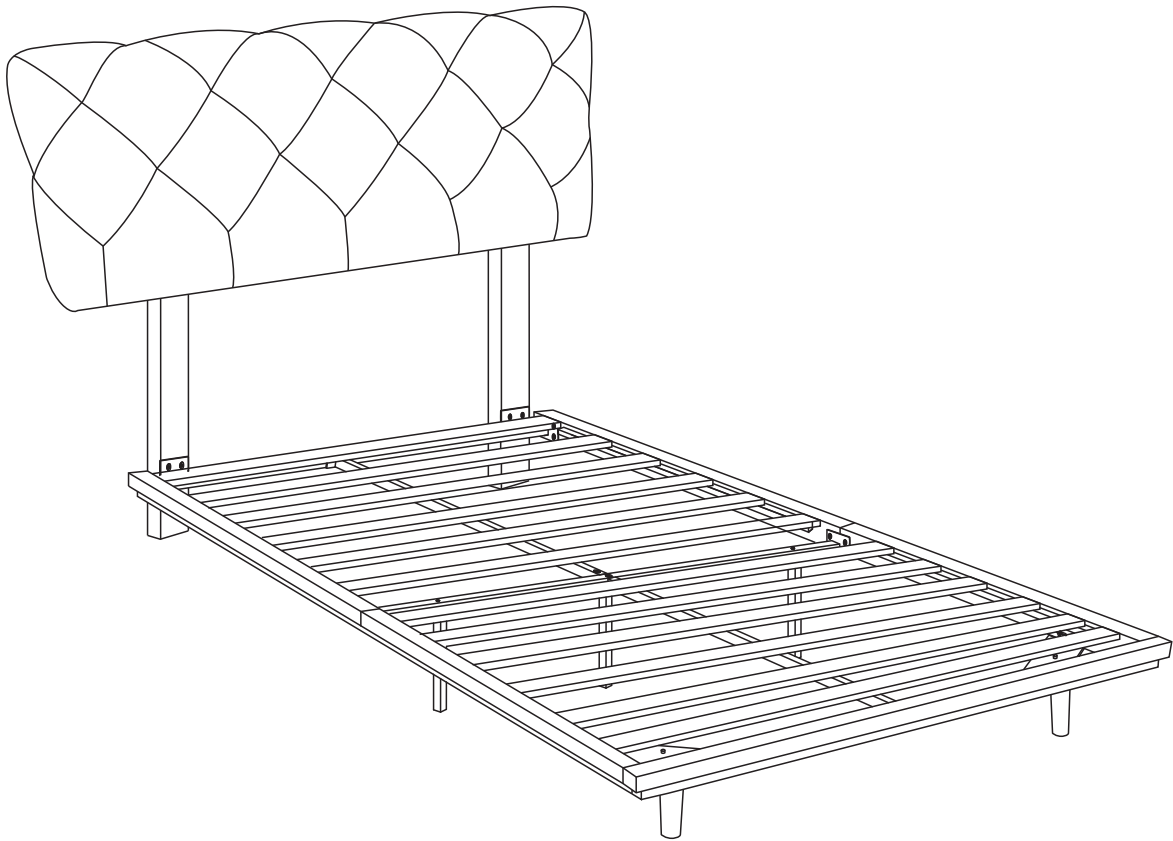

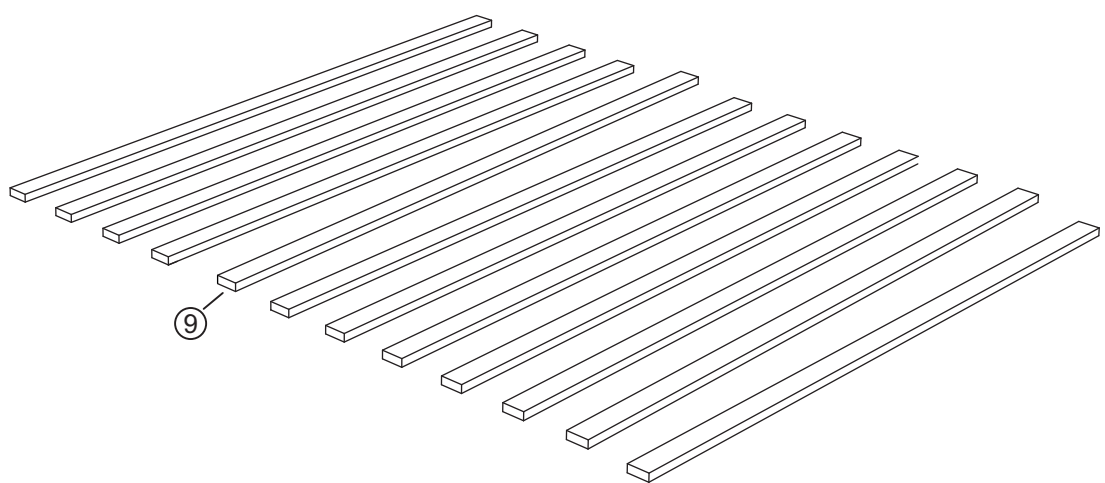

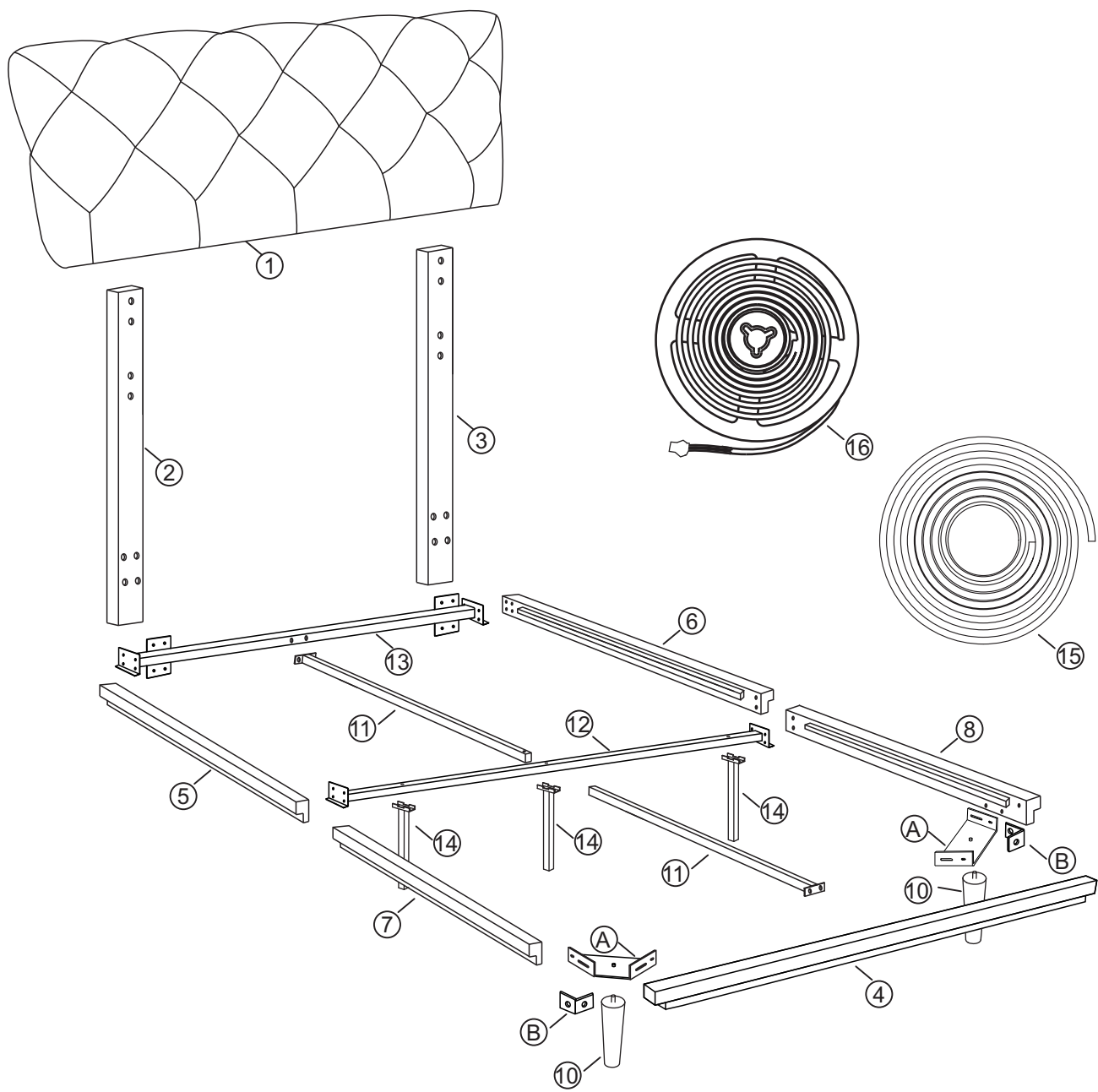





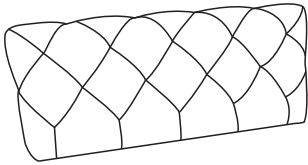

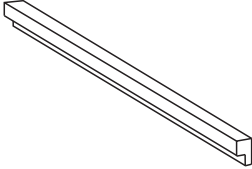
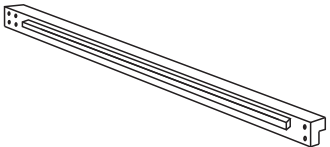
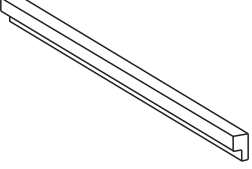
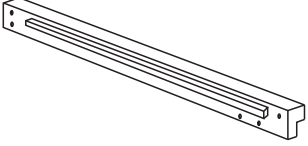
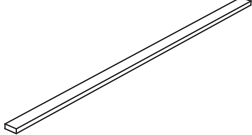

# Detail View

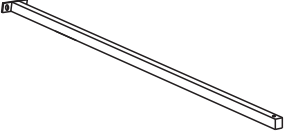

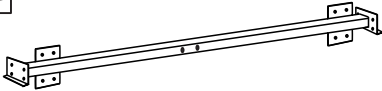

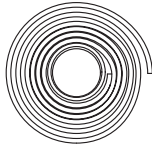

# Part List

WF315909AAE/WF315909AAA/WF315909AAH

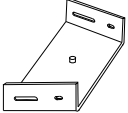
<p><b>1</b></p>  <p>Head board-1pc</p>	<p><b>2</b></p>  <p>Head board legs-1pc</p>	<p><b>3</b></p>  <p>Head board legs-1pc</p>
<p><b>4</b></p>  <p>Foot board-1pc</p>	<p><b>5</b></p>  <p>Bottom bed board-1pc</p>	<p><b>6</b></p>  <p>Bottom bed board-1pc</p>
<p><b>7</b></p>  <p>Bottom bed board-1pc</p>	<p><b>8</b></p>  <p>Bottom bed board-1pc</p>	<p><b>9</b></p>  <p>Slat 1SET (12PCS)</p>
<p><b>10</b></p>  <p>Bed legs (2pcs)</p>	<p><b>11</b></p>  <p>Center Rail (2pcs)</p>	<p><b>12</b></p>  <p>Center Rail (1pc )</p>
<p><b>13</b></p>  <p>Center Rail (1pc )</p>	<p><b>14</b></p>  <p>Support Leg(3pcs)</p>	<p><b>15</b></p>  <p>WELCRO (1pc)</p>
<p><b>16</b></p>  <p>Light belt (1pc)</p>		

# Hardware List

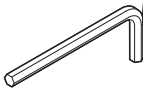
<p><b>A</b></p>  <p>Bracket (2pcs)</p>	<p><b>B</b></p>  <p>Connector (2pcs)</p>	<p><b>C</b></p>  <p>Bolt M8*40mm 9pcs</p>
<p><b>D</b></p>  <p>Bolt M8*20mm 40pcs</p>	<p><b>E</b></p>  <p>Allen Key M8 1PC</p>	

Attention: Do not tighten the screws before completing the entire installation. If you have any difficulty with the installation process, please feel free to contact us.

## Step 1

Fix the Headboard legs ② to the Headboard ① with Bolt K by using Allen key M. You can choose the hole a and c, or b and d.

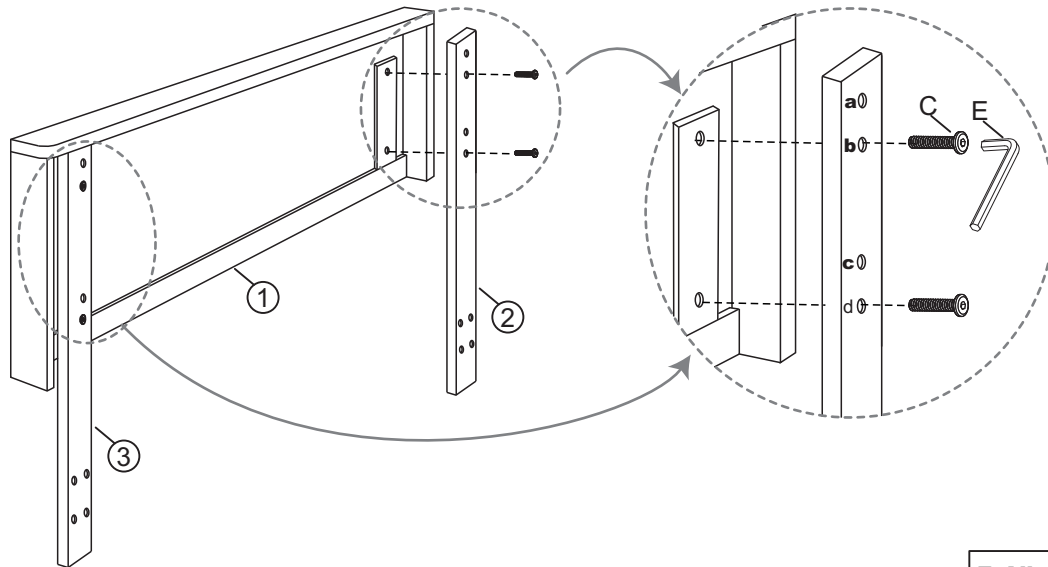



<b>E Allen Key</b> 	<b>C Bolts x 4</b>  M8X40mm
---	--

## Step 2

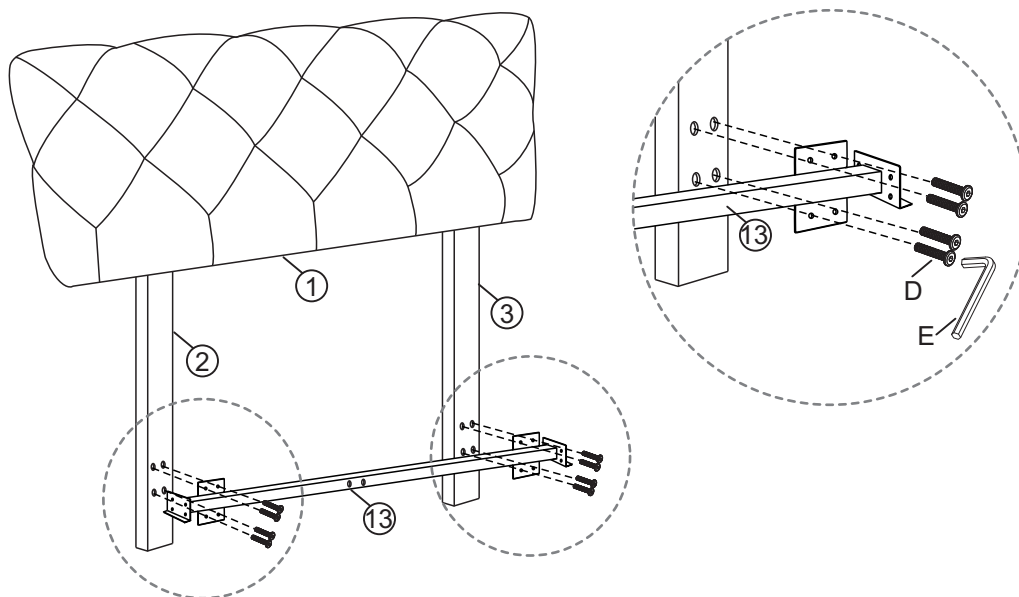
Fix the Headboard legs ② to the Headboard ① with Bolt B by using Allen key M. You can choose the hole ② and ③.



<b>E Allen Key</b> 	<b>D Bolts x 8</b>  M8X20mm
---	--

### Step 3

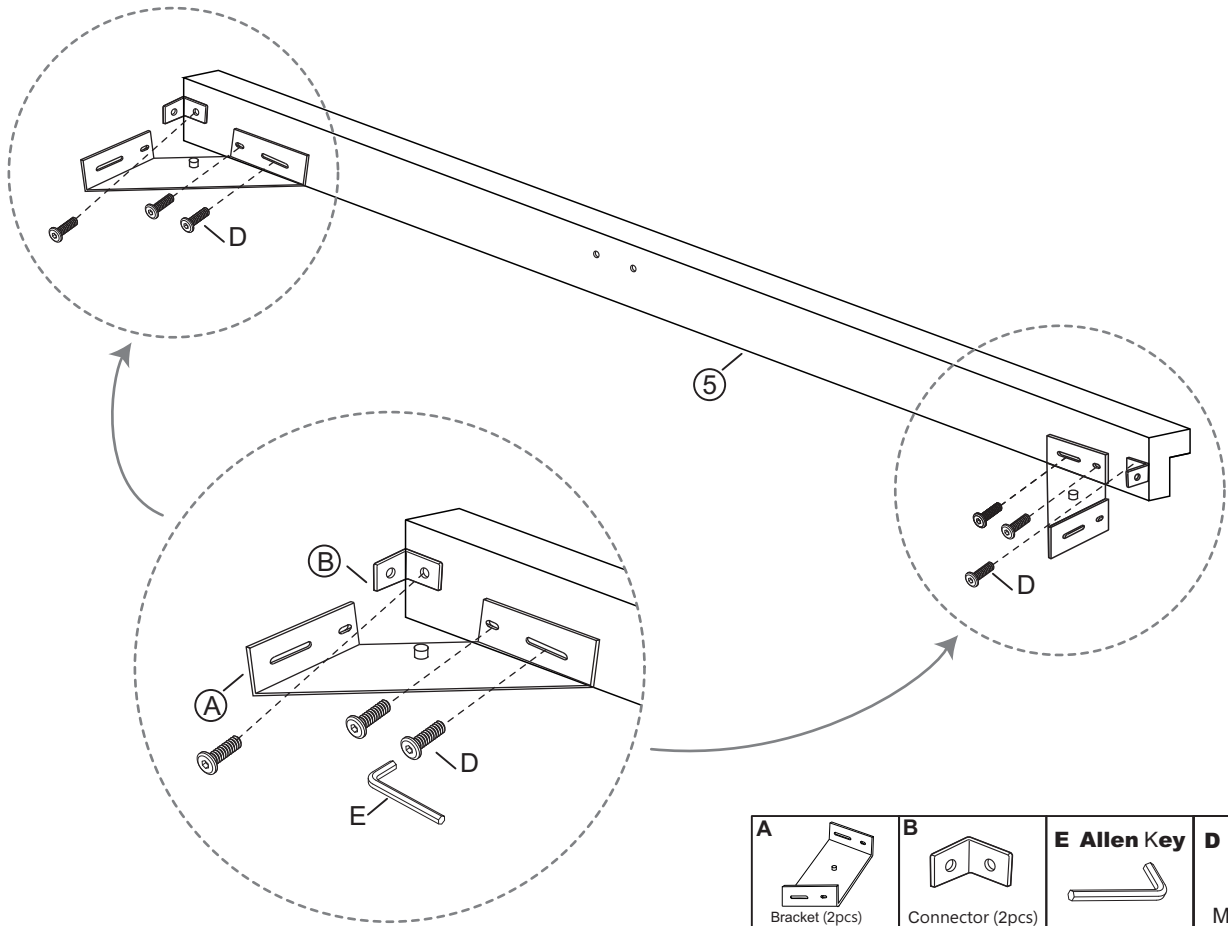

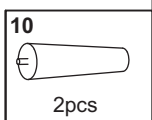
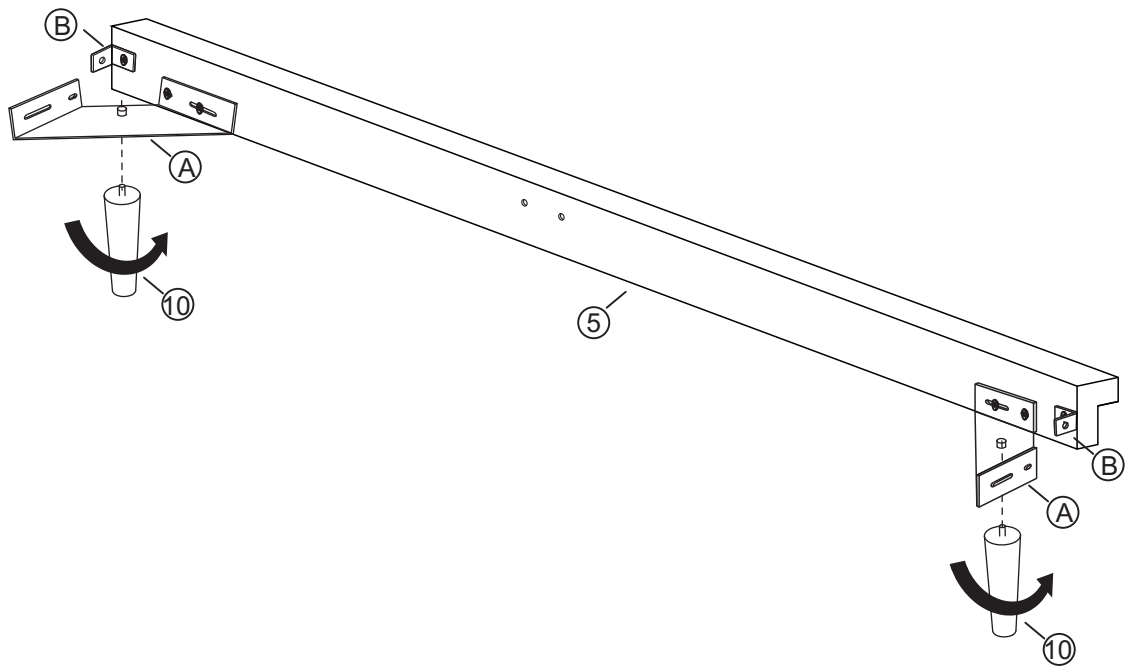

### Step 4



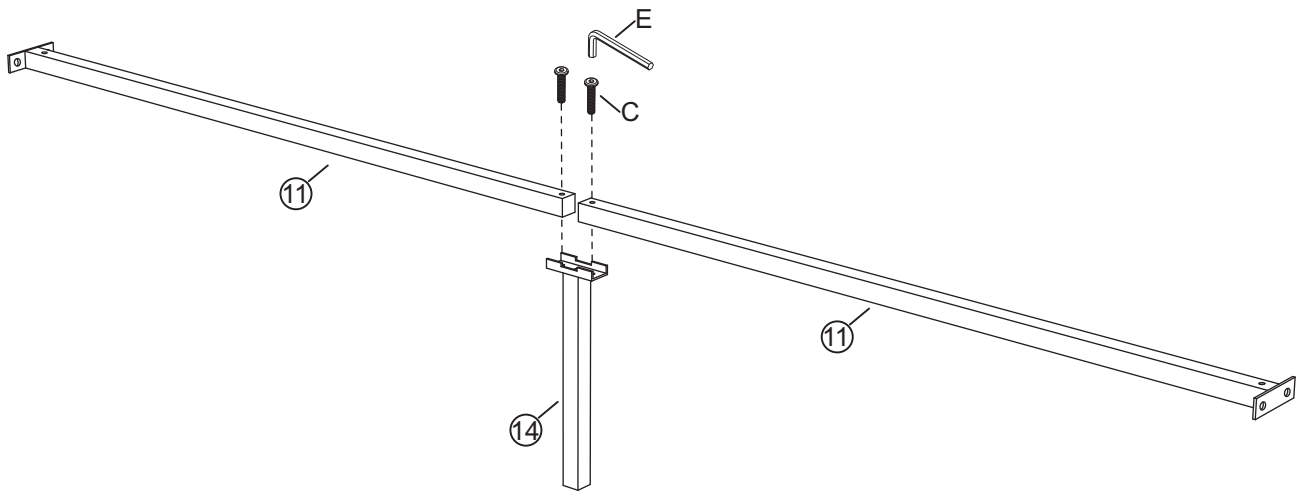

## Step 5

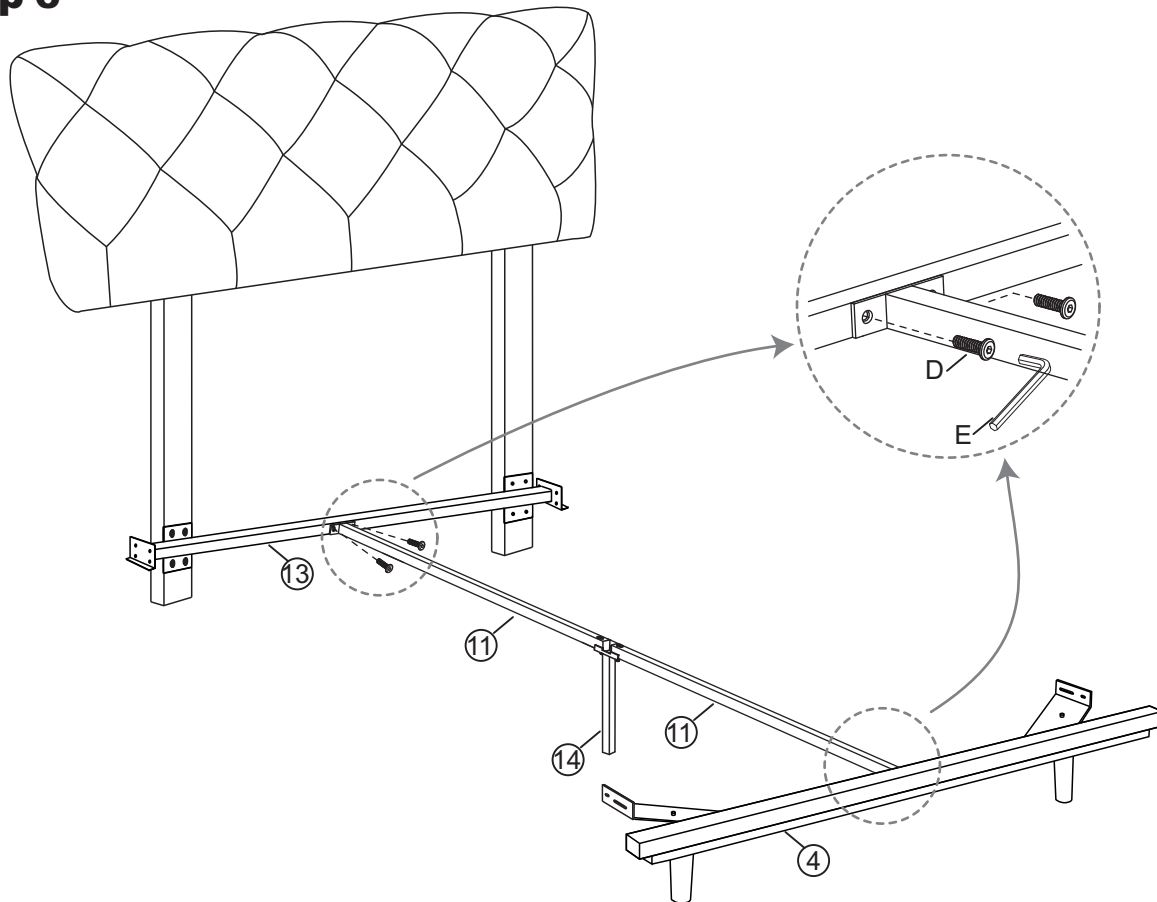

<b>E Allen Key</b>	<b>C Bolts x 2</b>
	
	<b>M8X40mm</b>

## Step 6



<b>E Allen Key</b>	<b>D Bolts x 4</b>
	
	<b>M8X20mm</b>

## Step 7

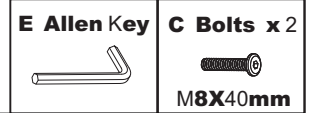
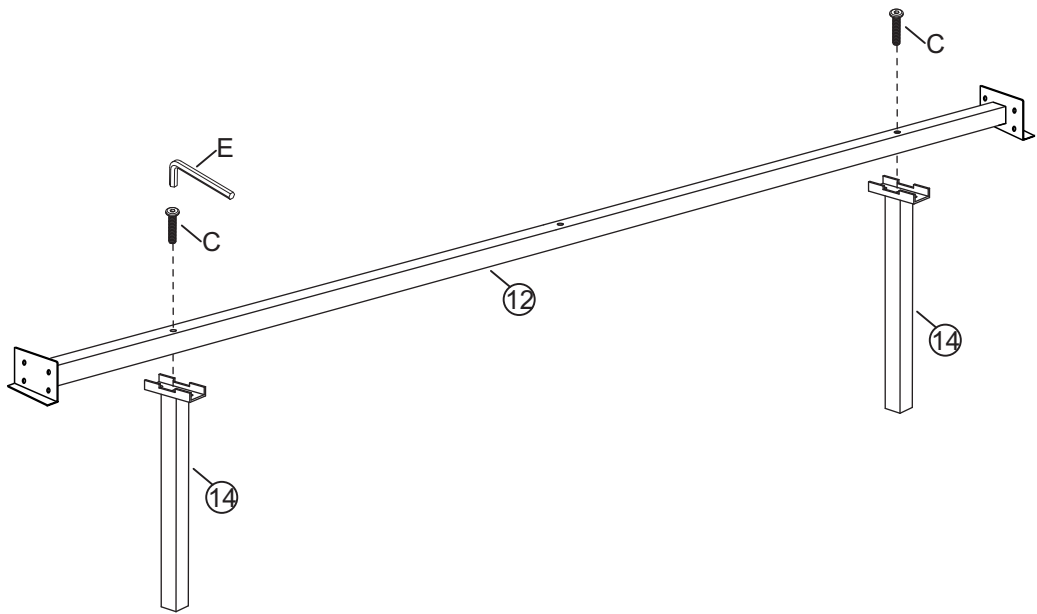

## Step 8

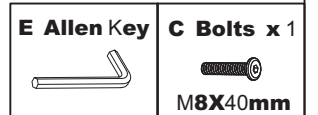
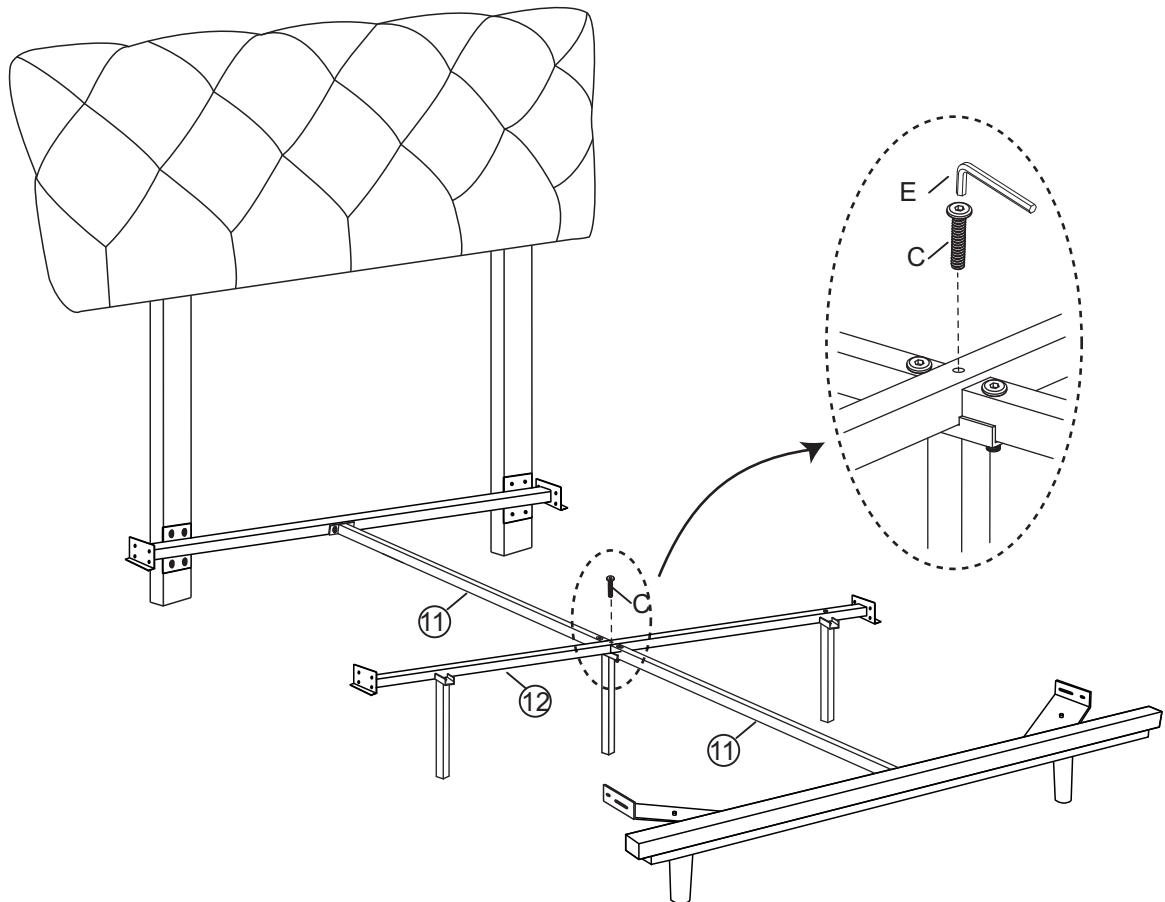

## Step 9

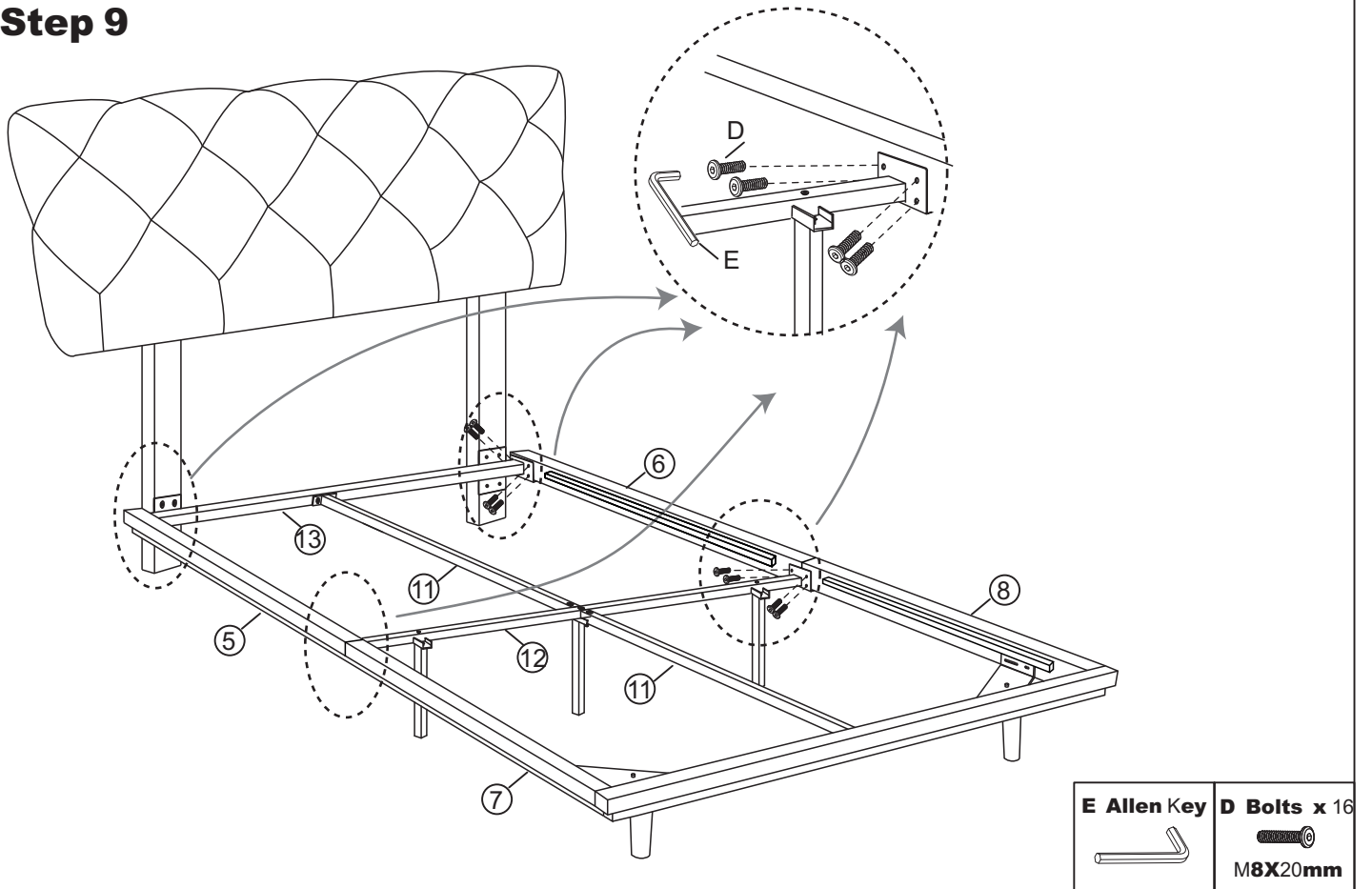

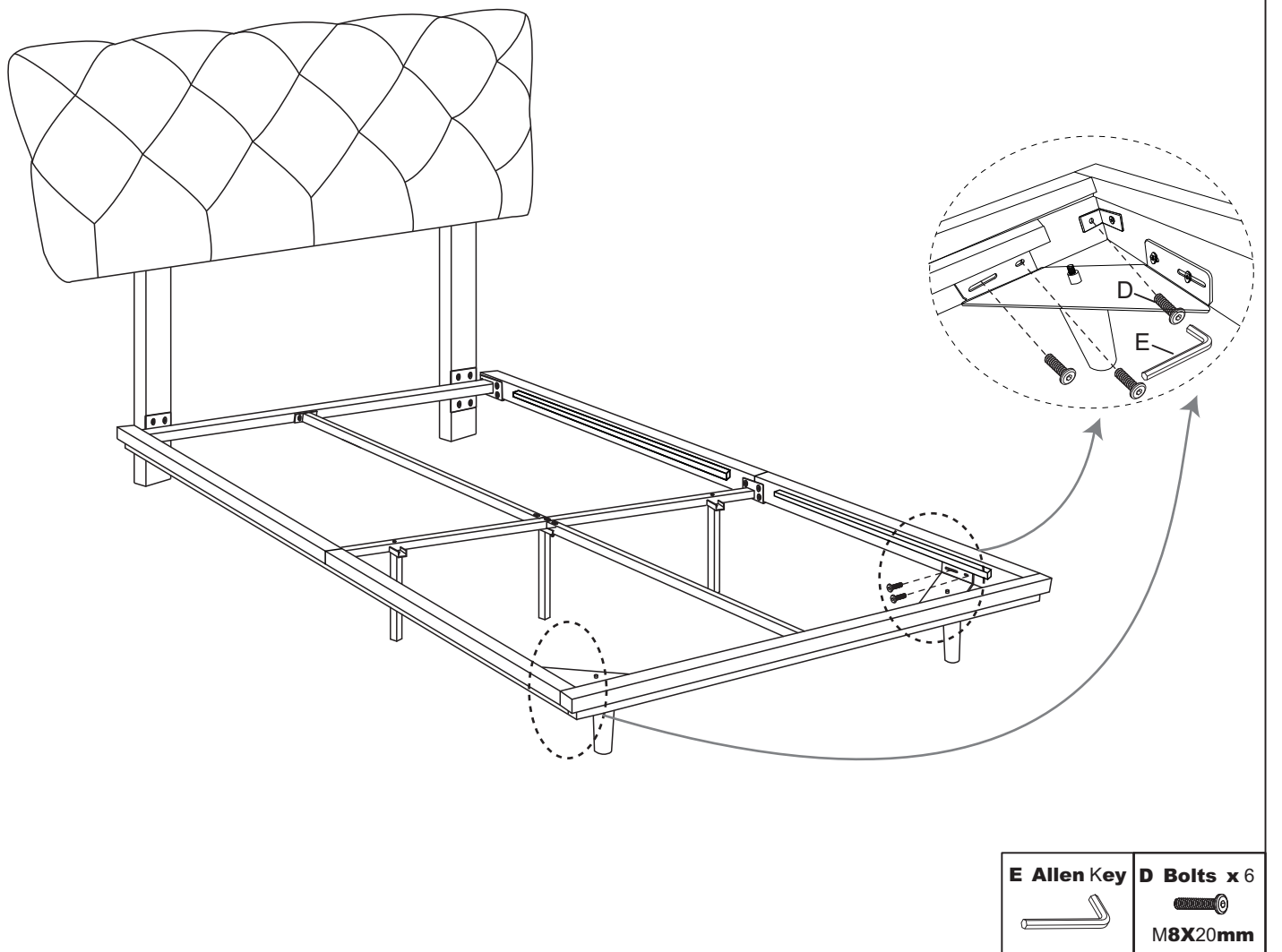

## Step 10

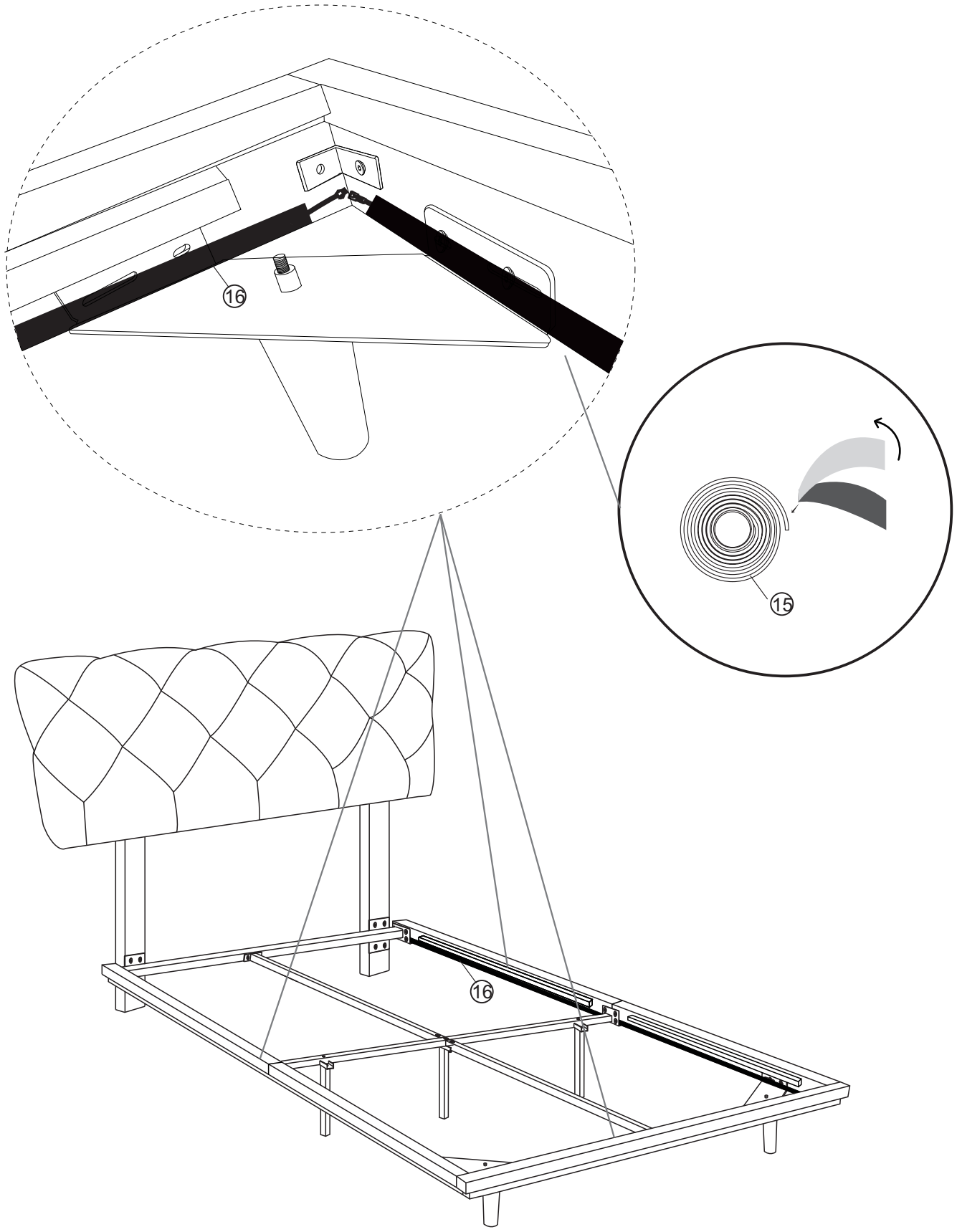

# Step 11



 1pc	 1pc
--	--

## Step 12

