

Assembly Instructions

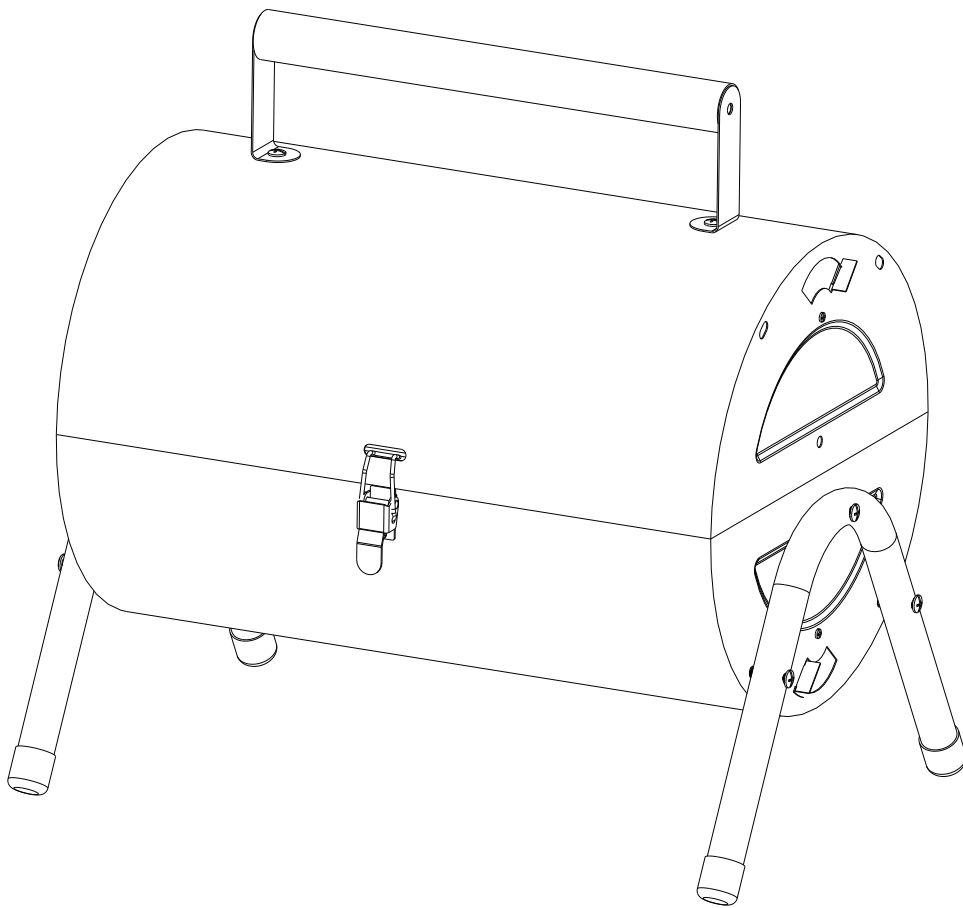

Portable Charcoal BBQ



Special Warnings

- This Deluxe Outdoor Charcoal Barbecue Grill With Wheels is intended for Outdoor Use Only!
- DO NOT use indoor!
- This barbecue will become very hot, do not move it during operation!
- Do not use spirit, petrol or any similar liquid for lighting or re-lighting!
- Keep children and pets away.

Operation Instructions

- All screws must be firmly driven in.
- Every care has been taken in the production process to eliminate sharp edges on your grill. Please handle the parts with care so as to avoid accidents or injury during assembly and when in cooking.
- Always wear gloves when moving the grill, because the grill handles can become very hot during cooking.
- Always select a safe and level location in a place suited for charcoal barbecue. Do not transport the grill when it is still hot.
- It is dangerous to attempt to operate the grill with liquid fuels.
- Before first cooking it is recommended to heat the grill and bring the coals to a glowing heat for at least 30 minutes.

Care and Maintenance

Heap charcoal pieces into a pyramid in the fuel bowl.

Position dry charcoal lighters evenly through this pyramid of coals.

Light the pyramid using a match.







Do not load the grill with meat until the coals are covered with a layer of ash.

Oil grilling skewers with a little vegetable oil and begin your barbecue.

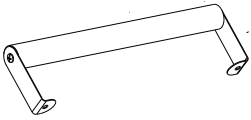
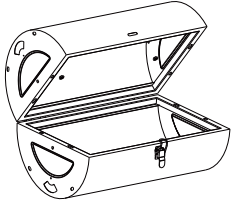
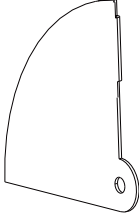
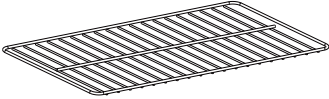
■ Assembly Instructions

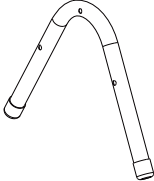
Estimated Assembly Time: 30 Minutes

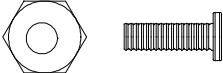
DO NOT over tighten hardware!

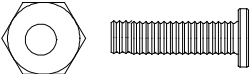
① x1pcs 	② x1pcs 	③ x4pcs 	④ x2pcs 
⑤ x2pcs 	⑥ x2pcs 	⑦ x1pcs 	AXM5X10mmX2 
BXM3X10mmX4 	CXM5X25mmX6 		

STEP 1

