

# **INSTALLATION**

## *Product Manual*

Version: 510059US-00-26A-HB

# Installation Instructions

---

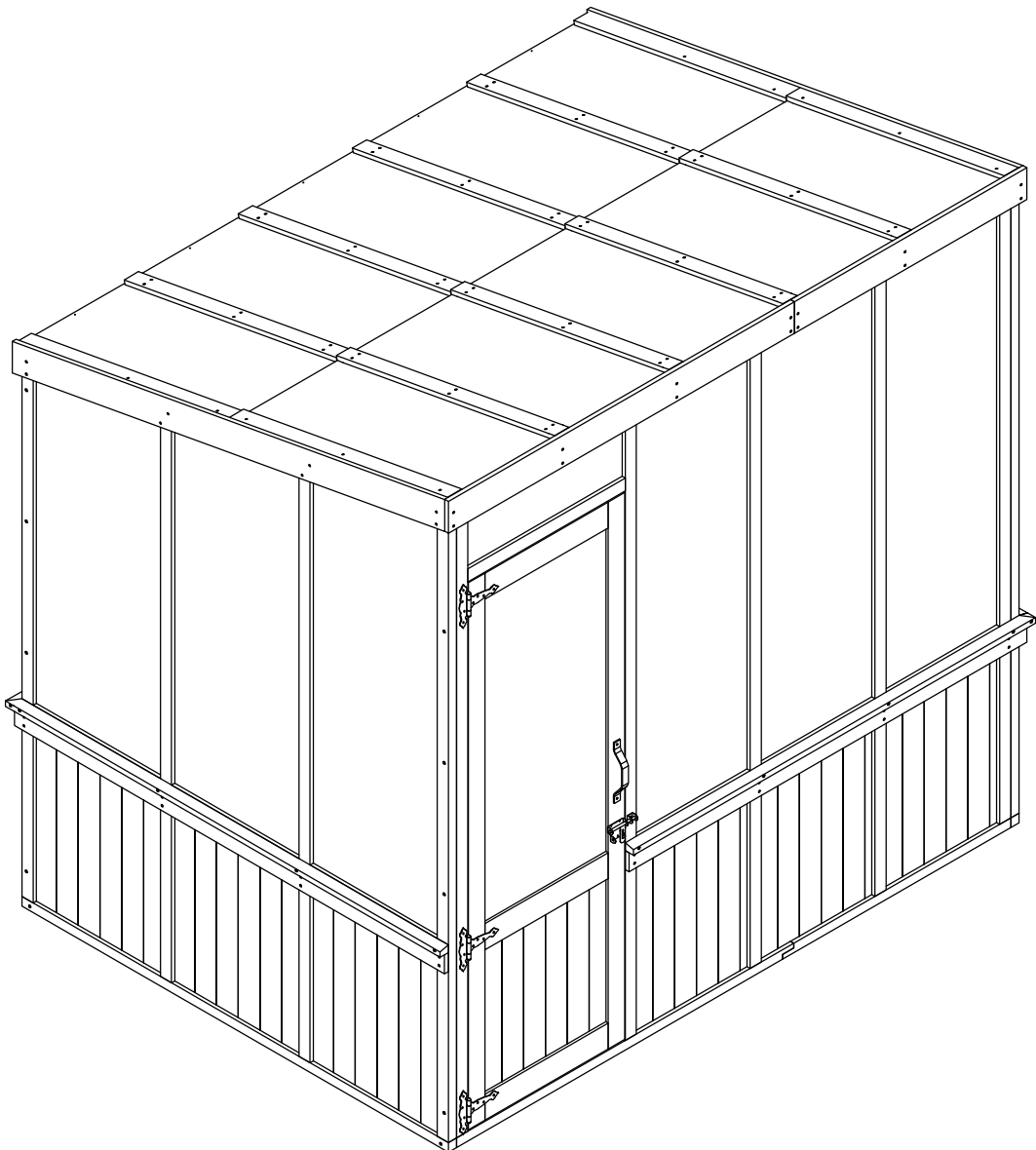

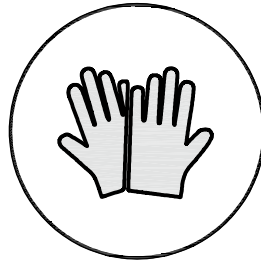
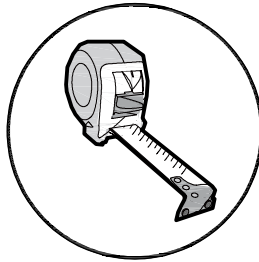
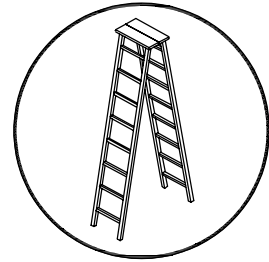
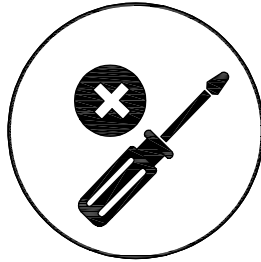
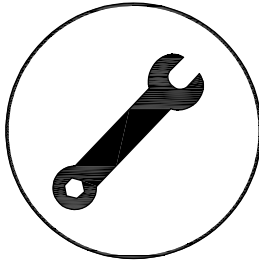
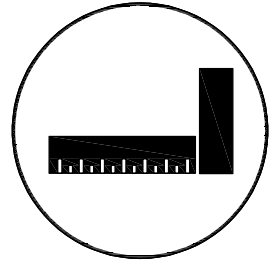
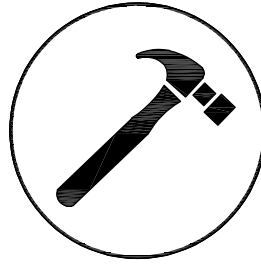
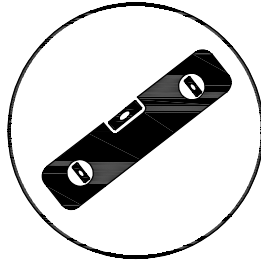
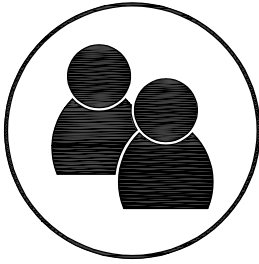

Icons and their uses you will see throughout this manual



You will need to make sure that your assembly is square before tightening your bolts.

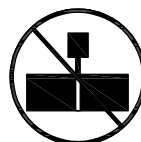

This icon warns you to not over tighten your bolts. This is to prevent structural damage and also splintering your wood.



For proper assembly you will need to ensure that your structure is level before proceeding to the next step.



This icon will show you what drill attachments are needed. For this example you will need a Phillips head attachment .



Some steps in the assembly process will require an extra set of hands. Make sure you have a helper available.



This size of the open-end wrench on these icons should correspond to the size of the nut.



It is required for high-altitude installation

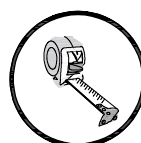

We need to measure the size and use it

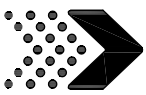

Wood Components (Not to Scale)

# BOX 1/3

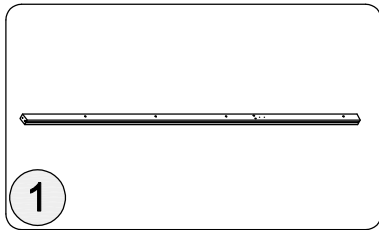

1

Left front pillar  
Qty: 1

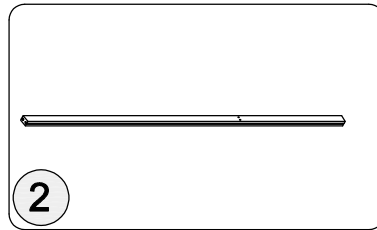

2

Left center pillar  
Qty: 1

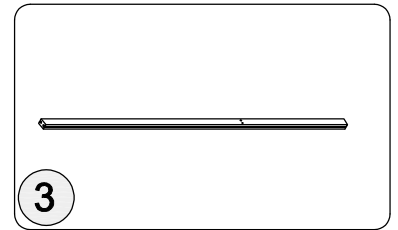

3

Left center pillar  
Qty: 1

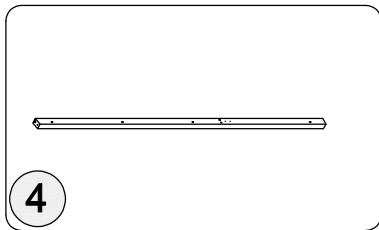

4

Left rear pillar  
Qty: 1

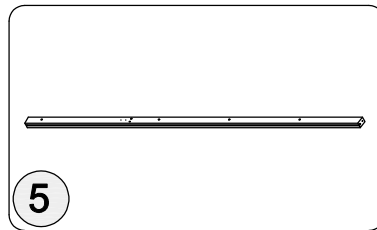

5

Right front pillar  
Qty: 1



6

Right center pillar  
Qty: 1

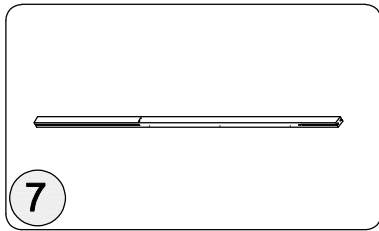

7

Right center pillar  
Qty: 1

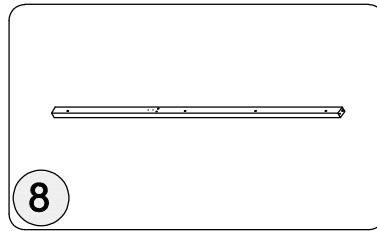

8

Right rear pillar  
Qty: 1

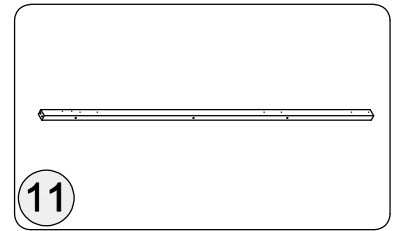

11

Front left pillar  
Qty: 1

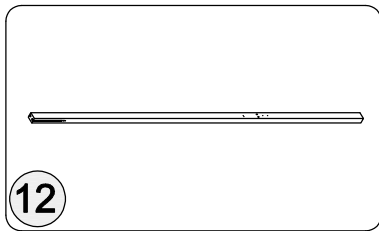

12

Center pillar  
Qty: 1

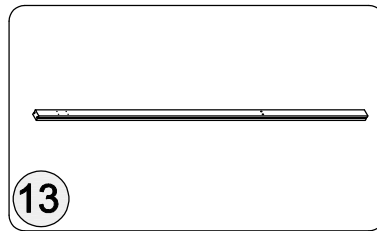

13

Center pillar  
Qty: 1

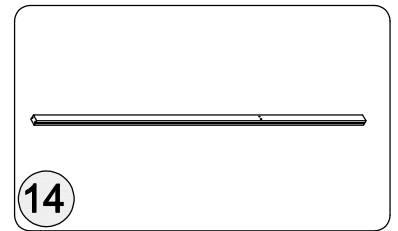

14

Center pillar  
Qty: 1

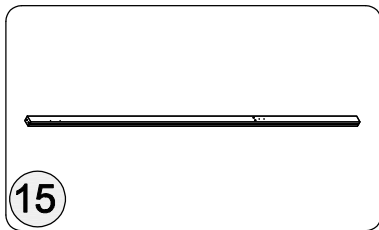

15

Front right pillar  
Qty: 1

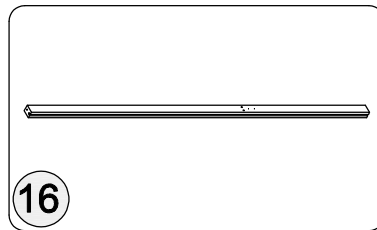

16

Rear left pillar  
Qty: 1

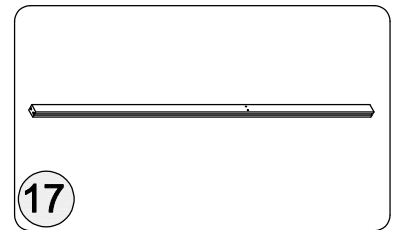

17

Rear center pillar  
Qty: 1

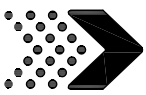

Wood Components (Not to Scale)

# BOX 1/3

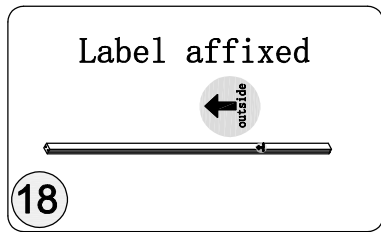

18

Rear center pillar  
Qty: 1

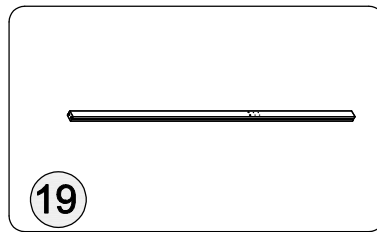

19

Rear center pillar  
Qty: 1

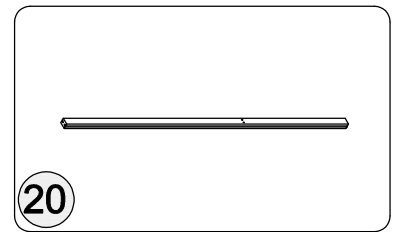

20

Rear center pillar  
Qty: 1

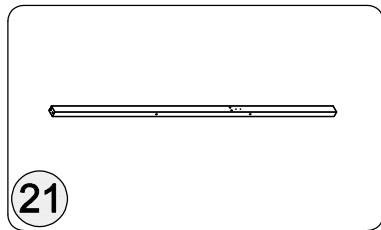

21

Rear right pillar  
Qty: 1

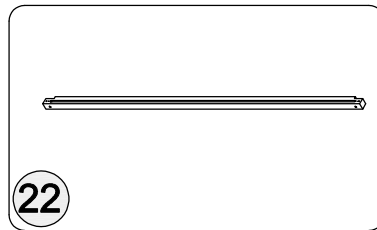

22

Side bottom Flat noodles  
Qty: 2

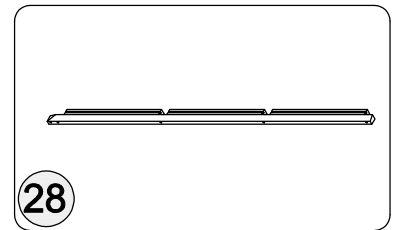

28

Left middle bar  
Qty: 1

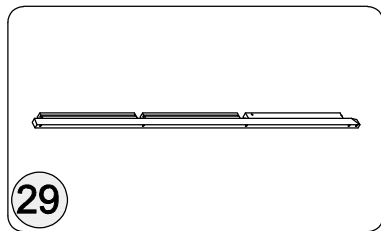

29

Right middle bar  
Qty: 1

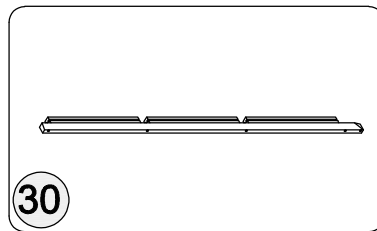

30

Front middle clause  
Qty: 1

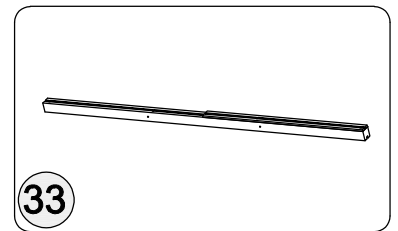

33

Left side beam  
Qty: 1

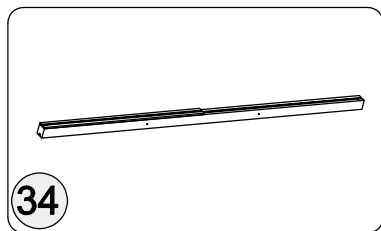

34

Right side beam  
Qty: 1

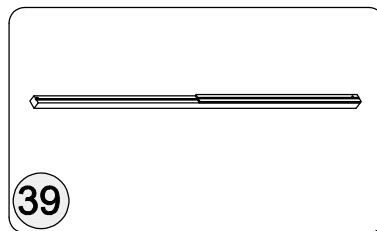

39

middle beam  
Qty: 4

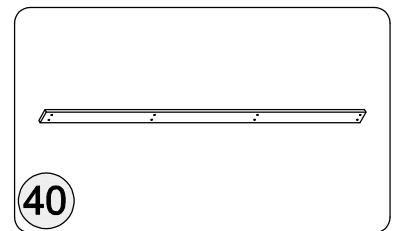

40

side baffle  
Qty: 2

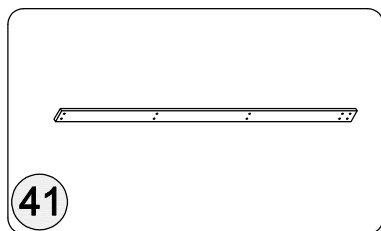

41

front fender  
Qty: 1

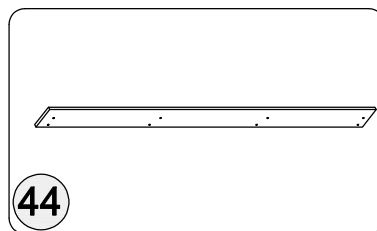

44

Top left baffle  
Qty: 1

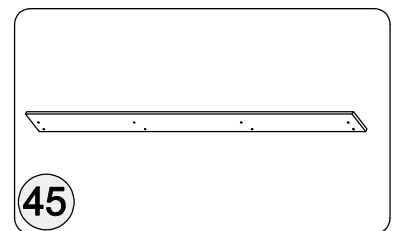

45

Top right baffle  
Qty: 1

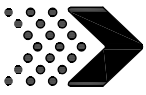

# BOX 1/3



56

door stop

Qty: 1

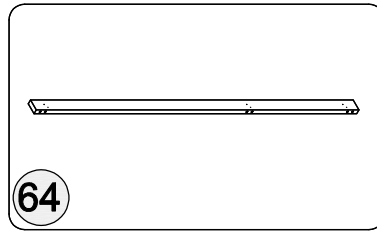

64

Left door strip

Qty: 1

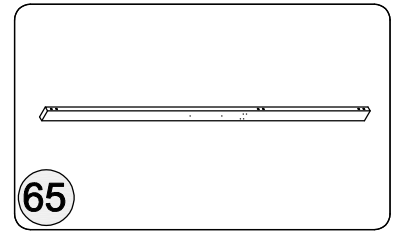

65

Right door strip

Qty: 1

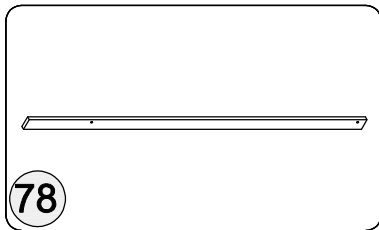

78

Right front gear strip

Qty: 1



Manual

Wood Components (Not to Scale)

# BOX 2/3

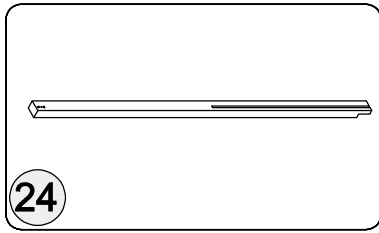

24

Front long bottom strip  
Qty: 1

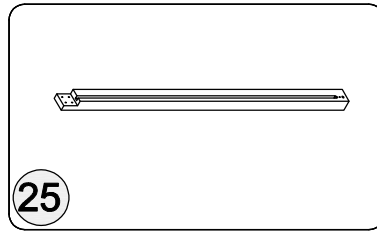

25

Front short bottom strip  
Qty: 1

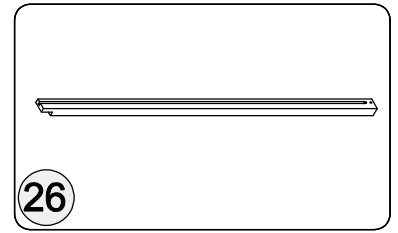

26

Rear long bottom strip  
Qty: 1



27

Rear short bottom strip  
Qty: 1

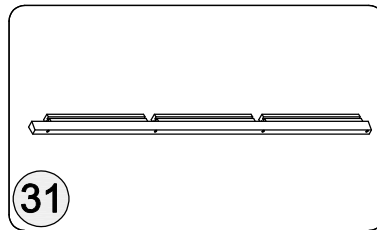

31

Rear middle strip  
Qty: 1

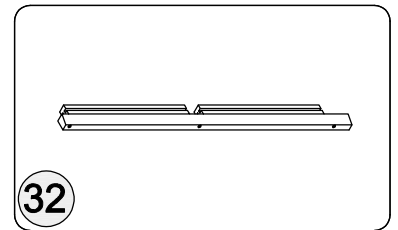

32

Rear middle short strip  
Qty: 1

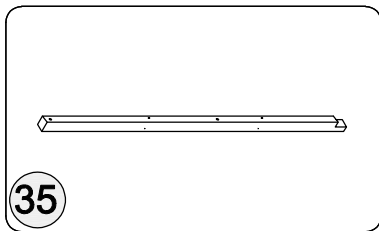

35

Front long beam  
Qty: 1

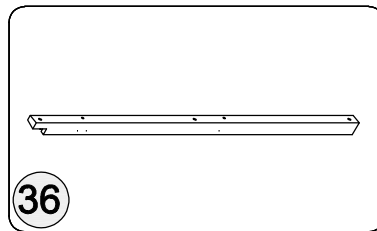

36

Front short beam  
Qty: 1

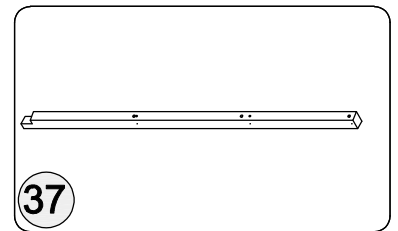

37

Rear long beam  
Qty: 1

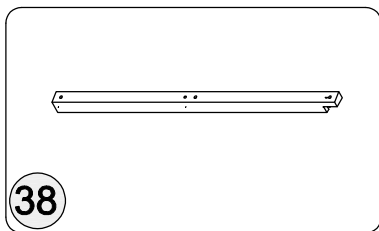

38

Rear short beam  
Qty: 1

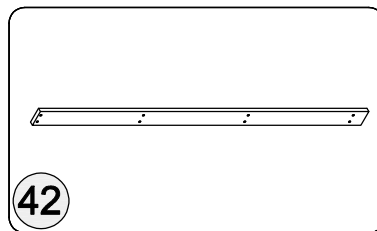

42

Rear long baffle  
Qty: 1

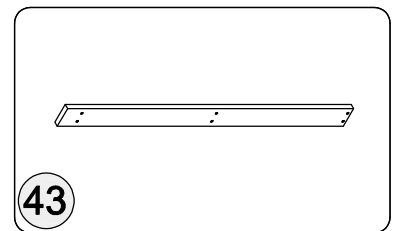

43

Rear short baffle  
Qty: 1

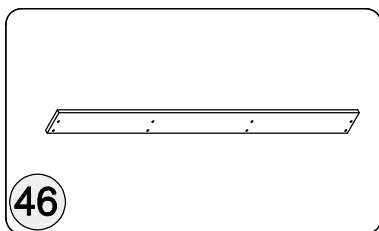

46

Top front long baffle  
Qty: 1

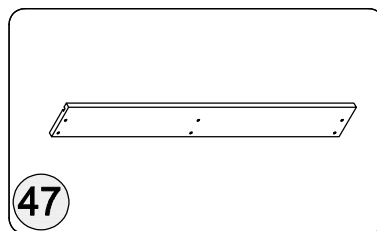

47

Top front short baffle  
Qty: 1

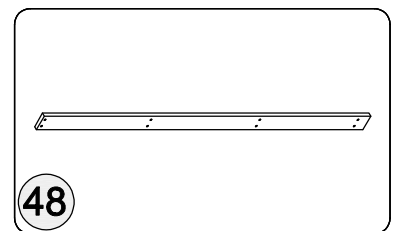

48

Top rear long baffle  
Qty: 1

Wood Components (Not to Scale)

# BOX 2/3

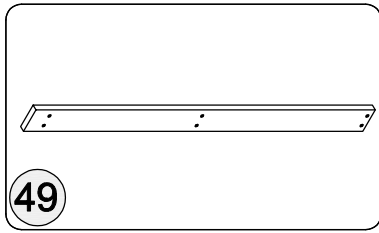

49

Top rear short baffle  
Qty: 1

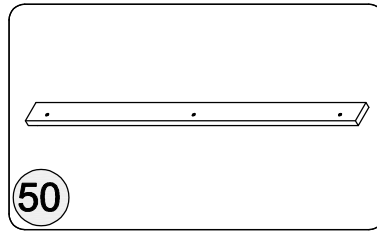

50

Top cover plate  
Qty: 2

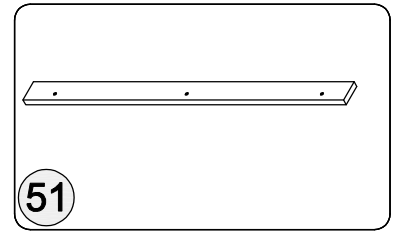

51

Top cover plate  
Qty: 2

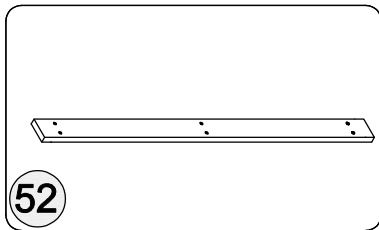

52

Top middle cover plate  
Qty: 4

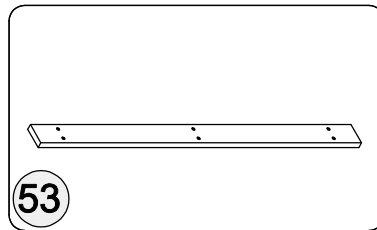

53

Top middle cover plate  
Qty: 4

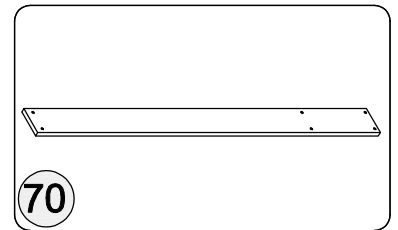

70

Rear left layer board  
Qty: 2

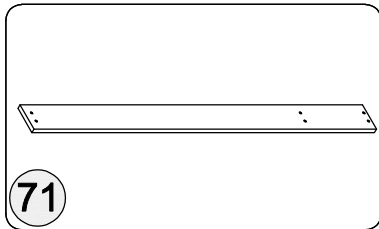

71

Rear left layer board  
Qty: 1

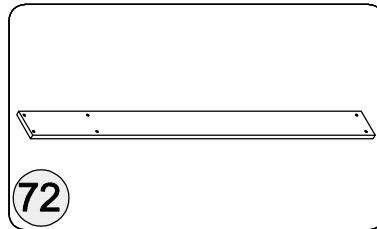

72

Rear right layer board  
Qty: 2

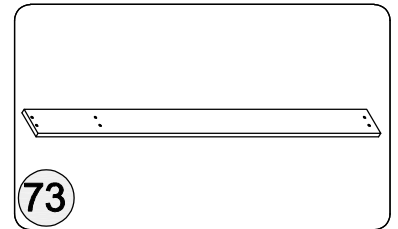

73

Rear right layer board  
Qty: 1

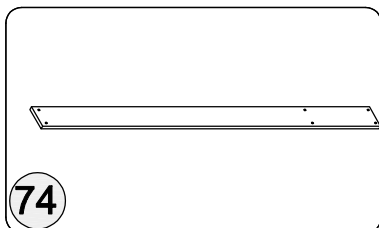

74

Right middle Flat noodles  
Qty: 1

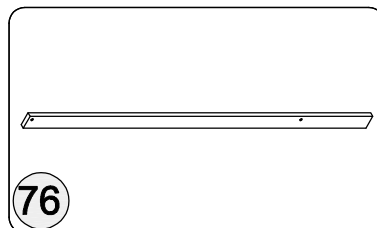

76

Front gear strip  
Qty: 1

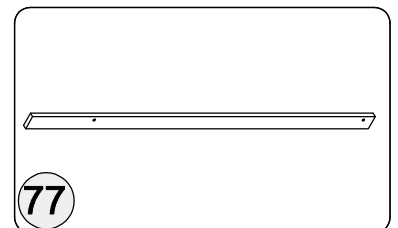

77

Front gear strip  
Qty: 1

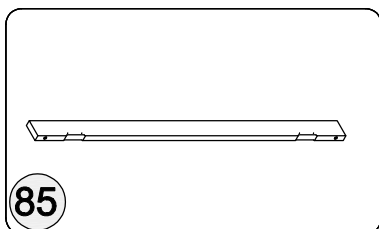

85

Left vertical bar  
Qty: 1

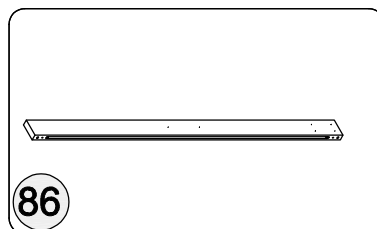

86

Right vertical bar  
Qty: 1

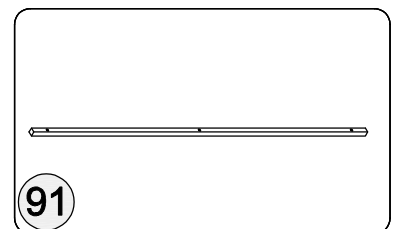

91

retaining strip  
Qty: 1

Wood Components (Not to Scale)

# BOX 2/3

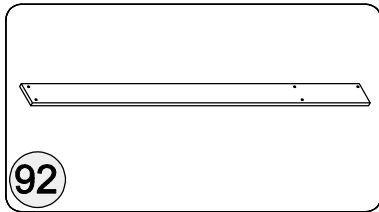

**Right rear Flat noodles**  
Qty: 1

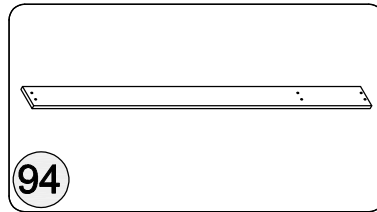

**Front right Flat noodles**  
Qty: 1

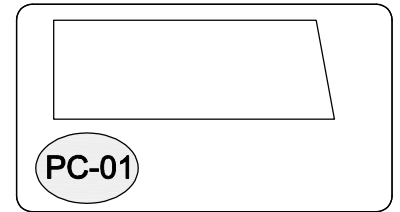

**Front Sunlight Panel**  
Qty: 1

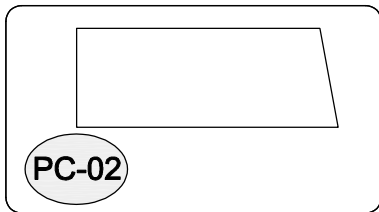

**Sunlight panel**  
Qty: 1

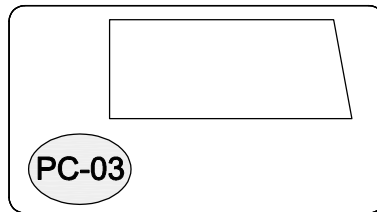

**Rear sunlight panel**  
Qty: 1

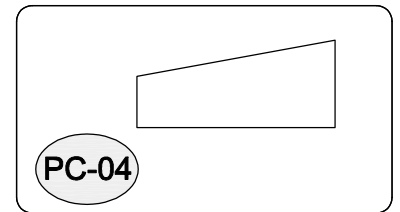

**Rear sunlight panel**  
Qty: 1

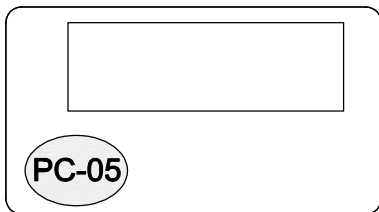

**Front Sunlight Panel**  
Qty: 3

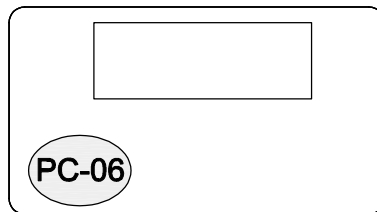

**Rear sunlight panel**  
Qty: 5

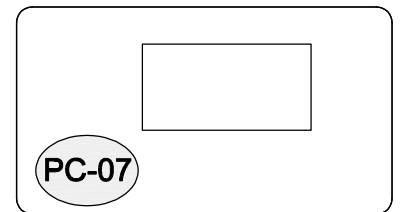

**Top Sunshine Board**  
Qty: 5

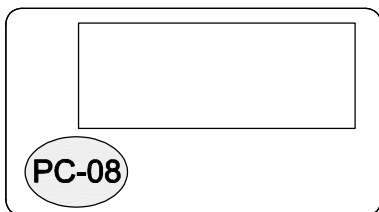

**Door Sunshine Board**  
Qty: 1

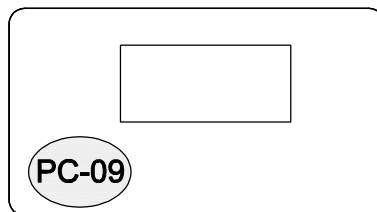

**Window Sunlight Panel**  
Qty: 1

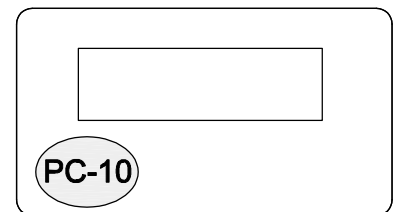

**Sunshine board on the door**  
Qty: 1

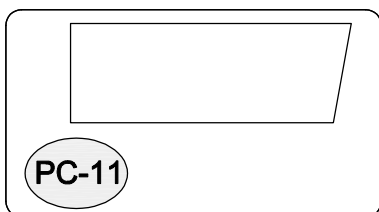

**Side sunlight panel**  
Qty: 1

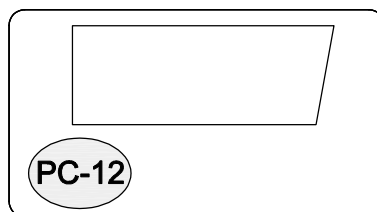

**Side sunlight panel**  
Qty: 1

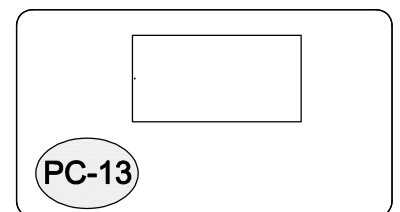

**Top rear sunlight panel**  
Qty: 5

Before installing each PC component, the film should be peeled off first

# BOX 3/3

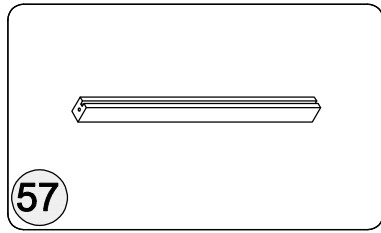

**57**  
Door strip  
Qty: 1

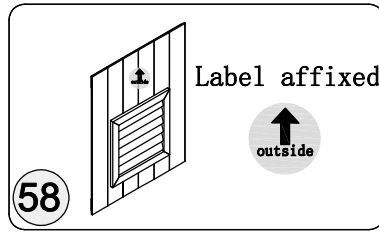

**58**  
Side core board  
Qty: 1

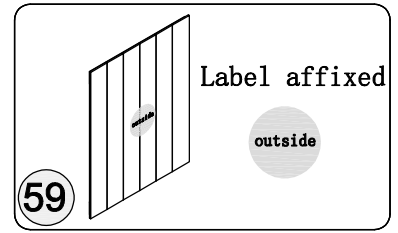

**59**  
Side core board  
Qty: 5

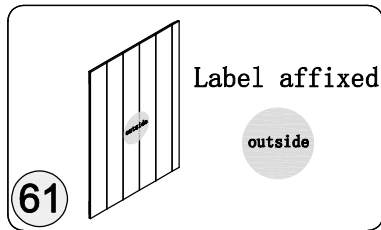

**61**  
Front core board  
Qty: 3

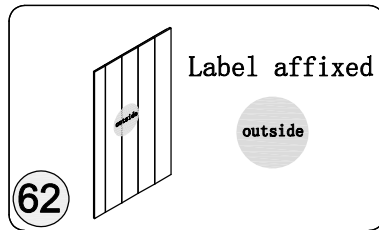

**62**  
Rear core board  
Qty: 4

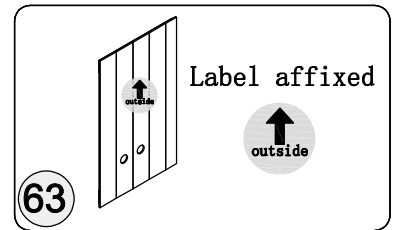

**63**  
Rear core board  
Qty: 1

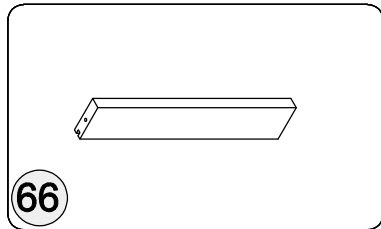

**66**  
Above the door strip  
Qty: 1

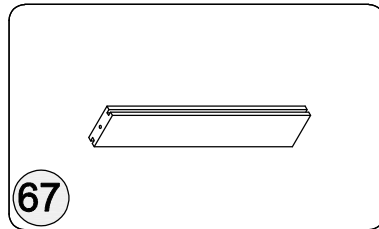

**67**  
Door side clause  
Qty: 1

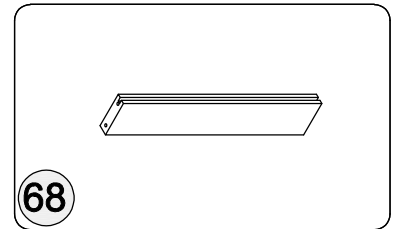

**68**  
Door bottom strip  
Qty: 1

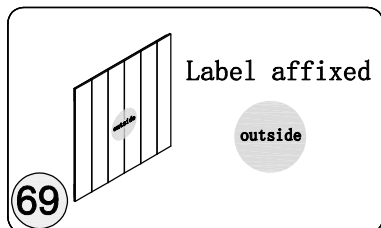

**69**  
Door core board  
Qty: 1

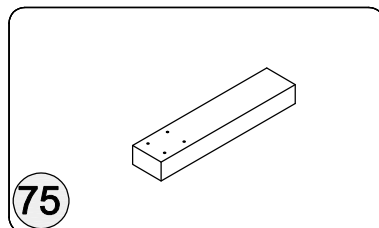

**75**  
connecting strip  
Qty: 1

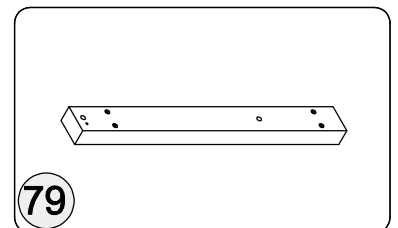

**79**  
vertical bar  
Qty: 5

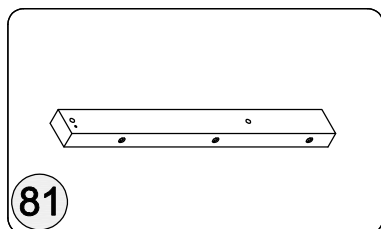

**81**  
Right vertical bar  
Qty: 1

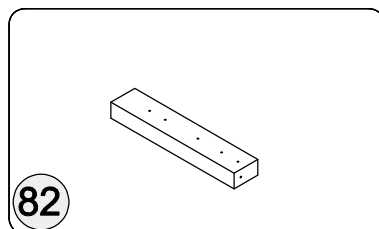

**82**  
Triangular horizontal bar  
Qty: 6

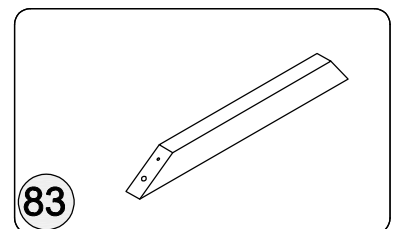

**83**  
Triangular diagonal bar  
Qty: 6

# BOX 3/3

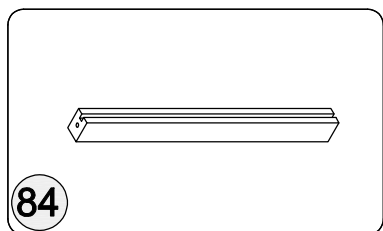

Noodles on the window  
Qty: 1

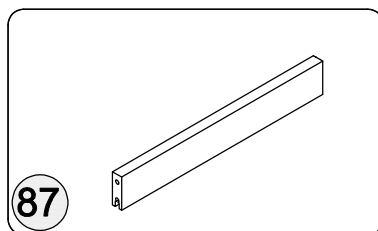

Up and down wooden strips  
Qty: 2

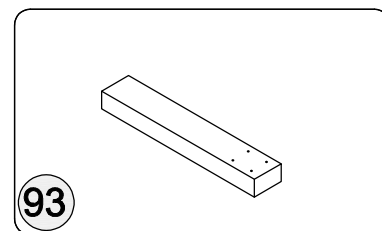

connecting strip  
Qty: 1

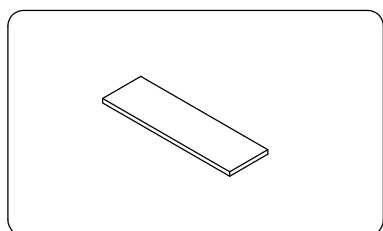

guide plate  
Qty: 2



Hardware

Hardware Components

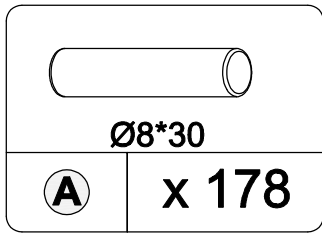

Wooden tenons

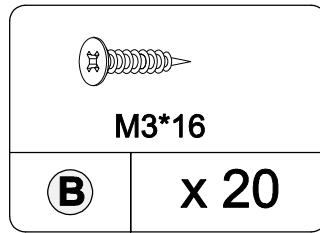

Screw

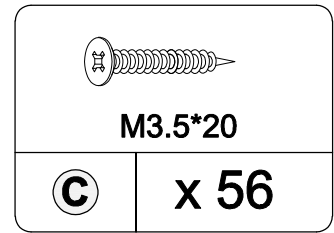

black screw

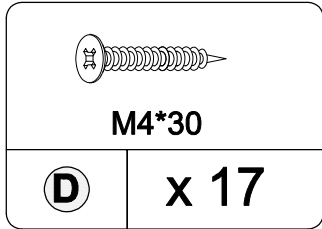

Screw

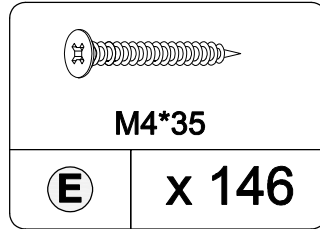

Screw

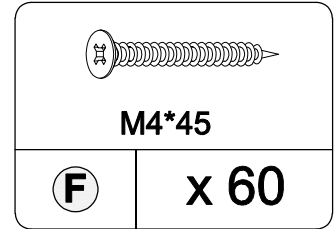

Screw

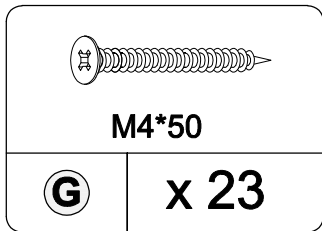

Screw

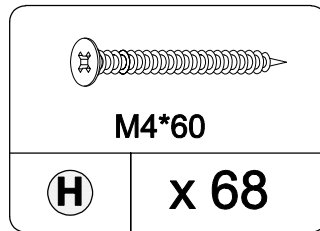

Screw

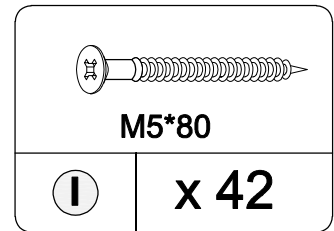

Screw

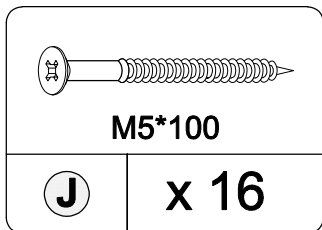

Screw

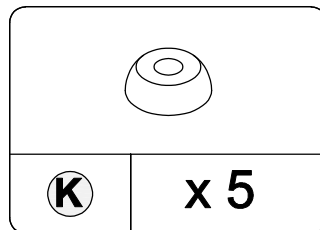

Block inch lid

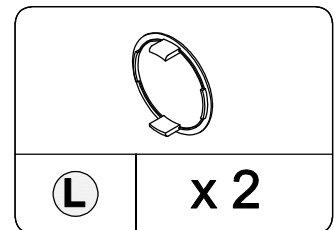

Outlet cover

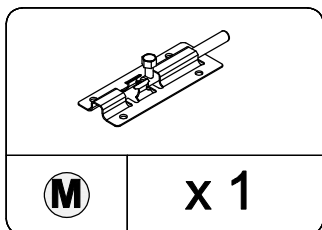

plug

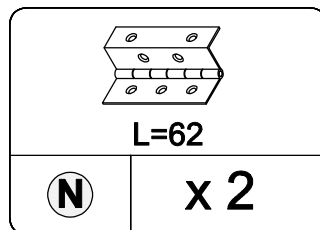

Hinge

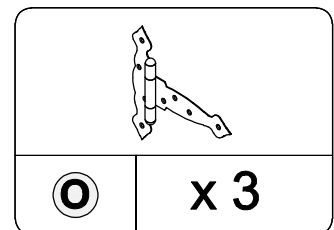

Hinge

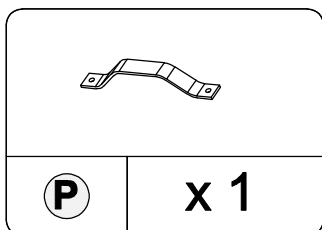

Lam door

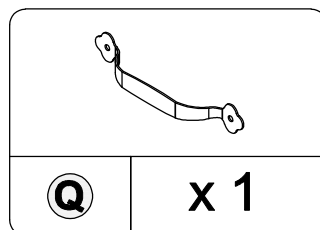

Lam door

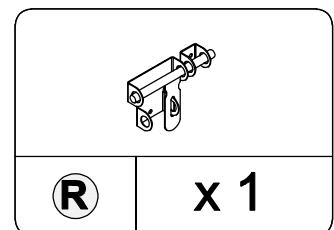

plug

Hardware Components

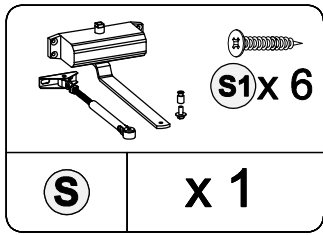

gas spring

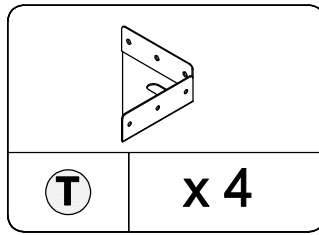

corner mark

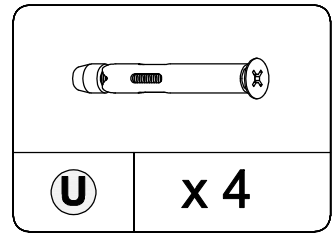

Earth screw

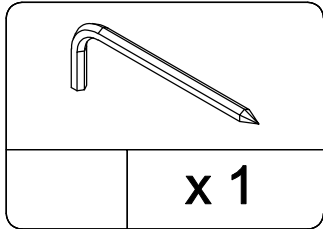

Hex key

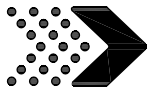

It is recommended to first locate and gather all the parts according to this diagram, which will facilitate quick installation later.

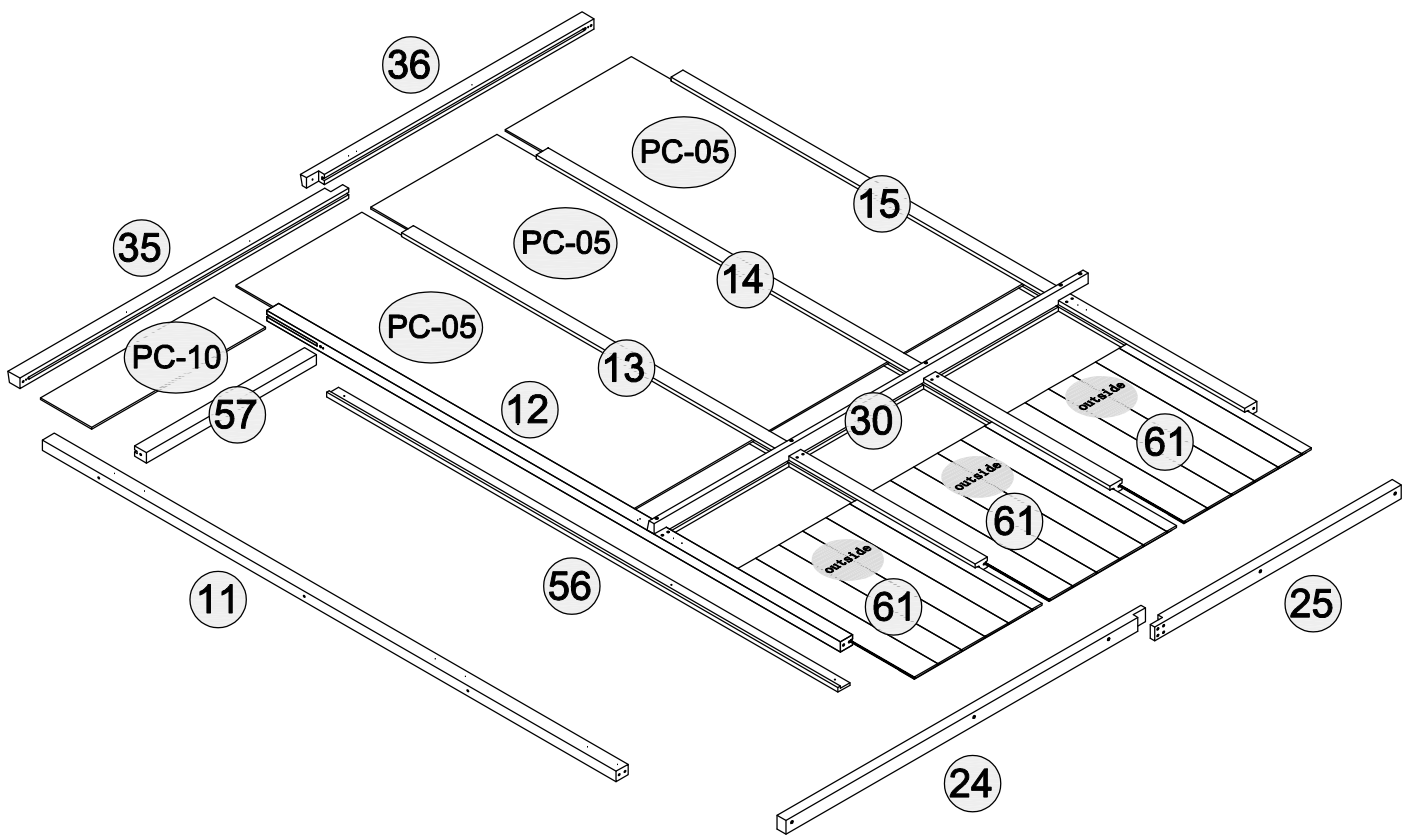

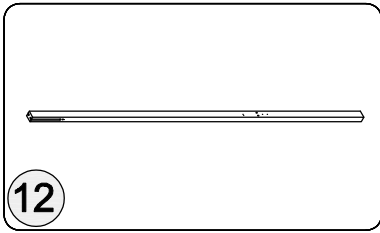
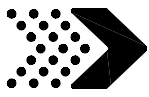

12

Center pillar  
Qty: 1

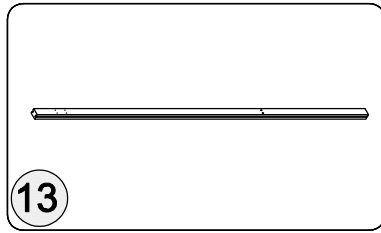

13

Center pillar  
Qty: 1

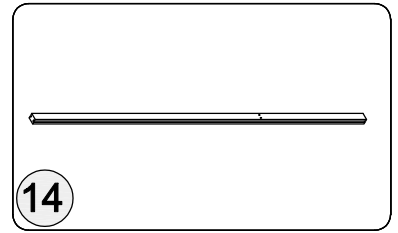

14

Center pillar  
Qty: 1

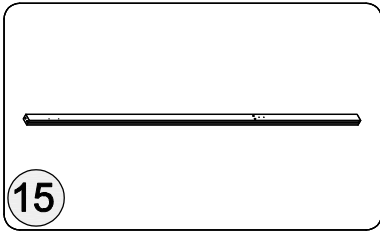

15

Front right pillar  
Qty: 1

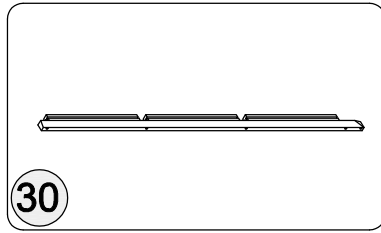

30

Front middle clause  
Qty: 1

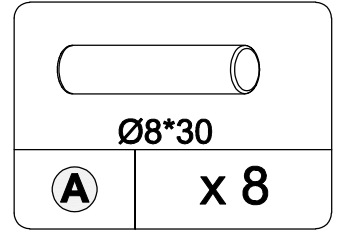

1. Connect with hardware A first

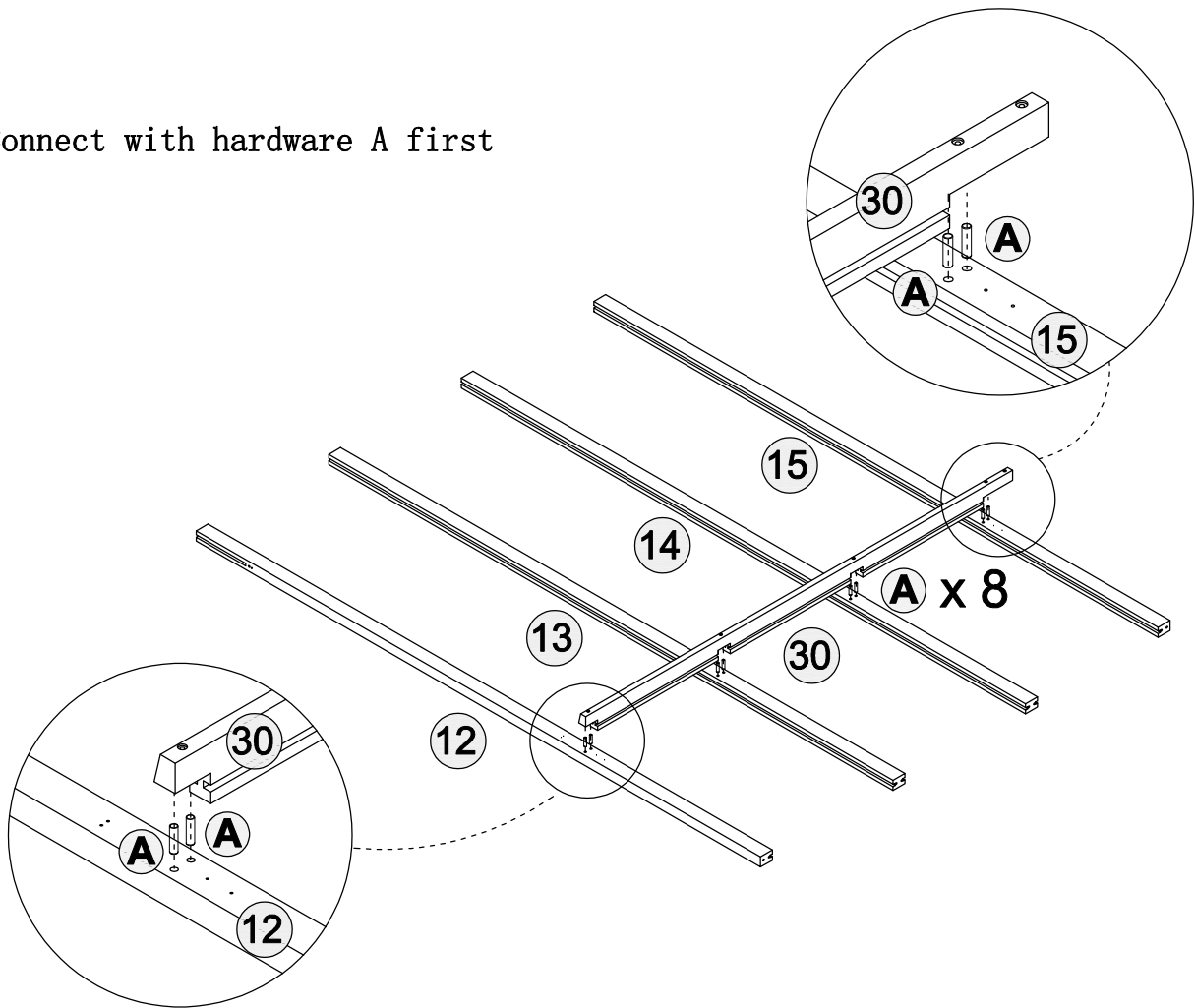

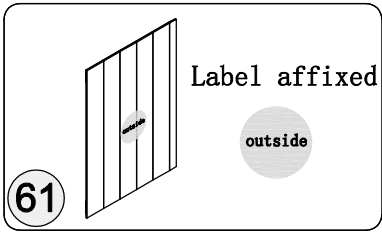

**61**  
Front core board  
Qty: 3

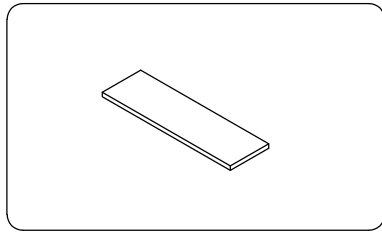

guide plate  
Qty: 2

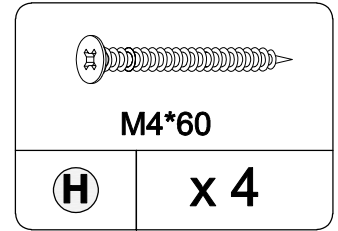

1. Connect with hardware H
2. Before installing component 61, insert the guide plate into the slot to align the slot
3. Place the 61-side plate into the side slot

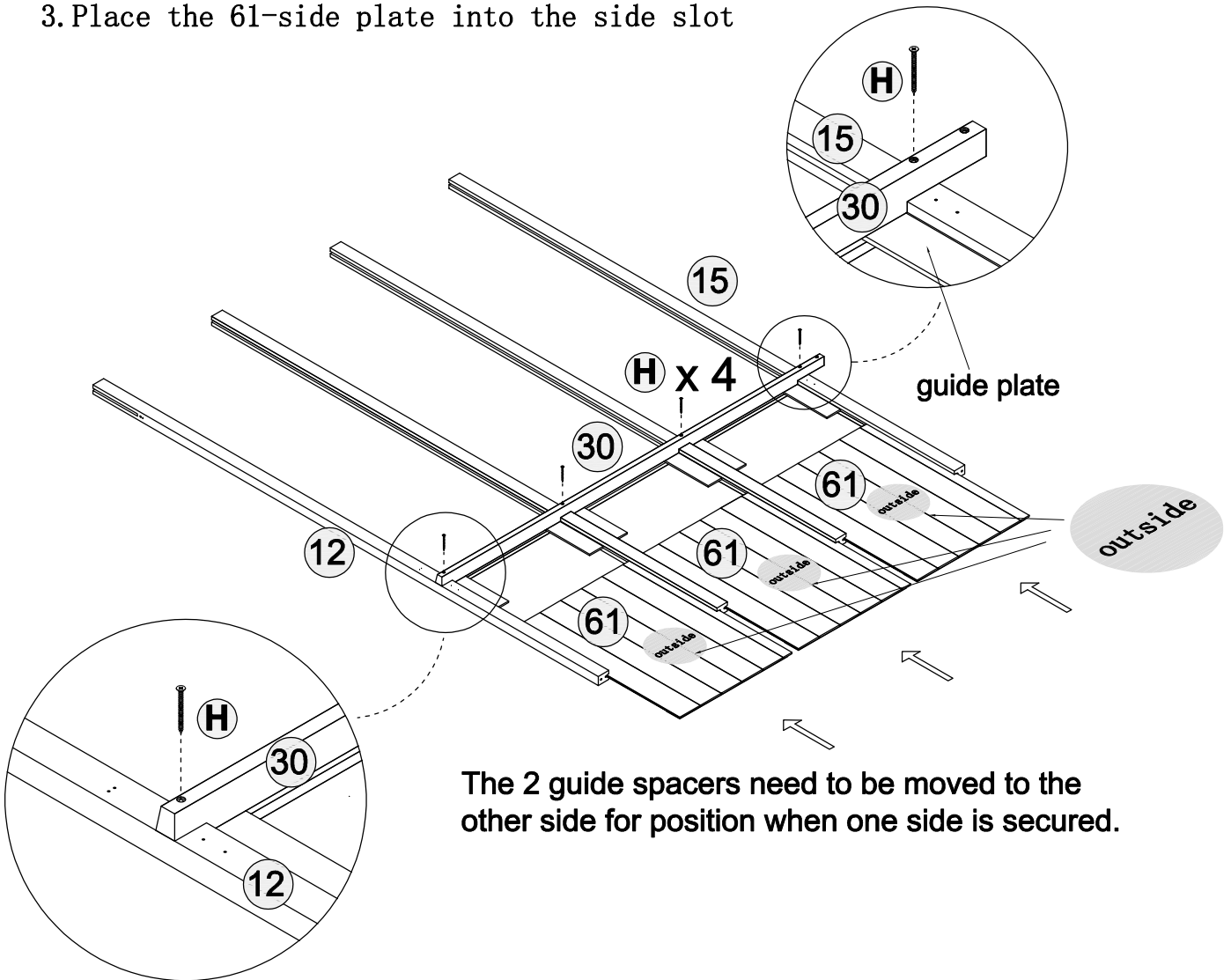

The 2 guide spacers need to be moved to the other side for position when one side is secured.

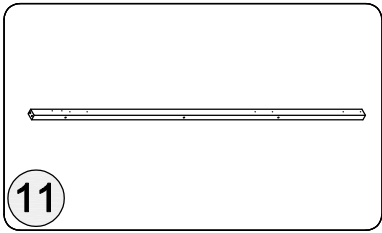

**11**  
Front left pillar  
Qty: 1

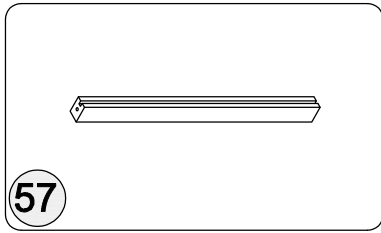

**57**  
Door strip  
Qty: 1

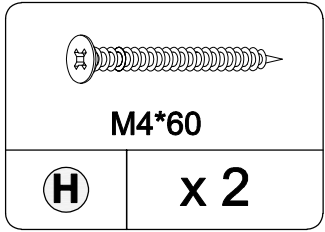
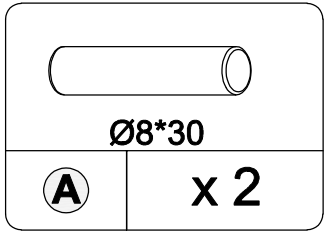

1. Connect with hardware A first, then install with hardware H

 2. Note that slot 57 is facing upwards and there is a lead hole behind the left end

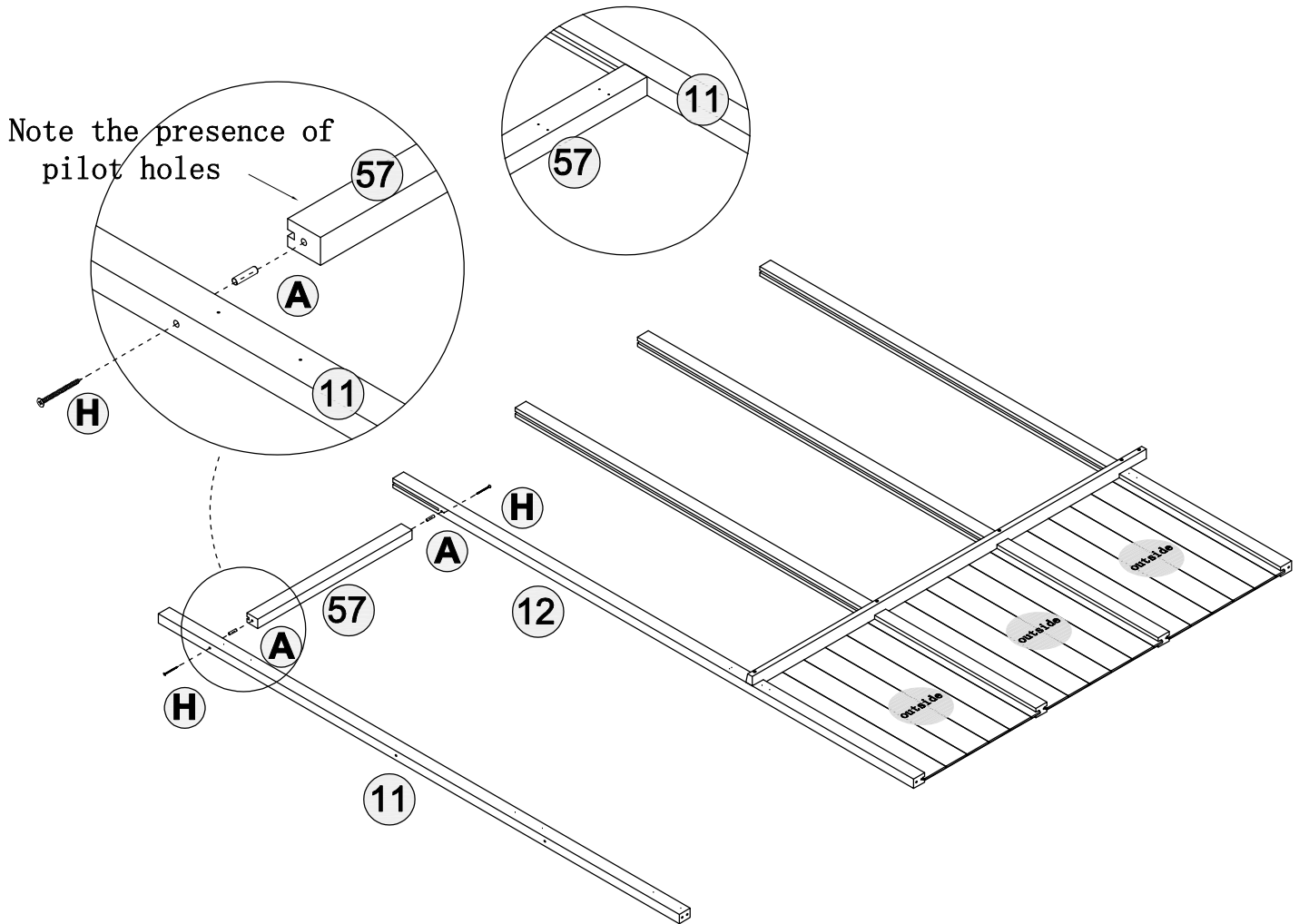

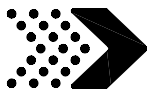

# Front frame installation

## Step 5

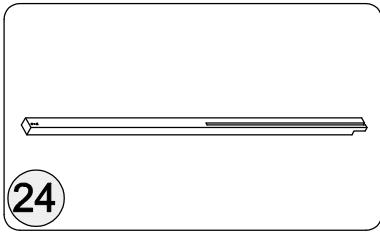

**24**  
Front long bottom strip  
Qty: 1

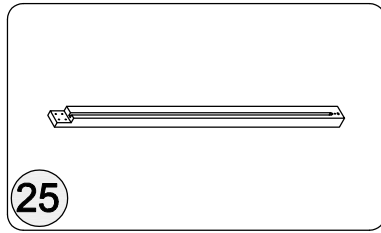

**25**  
Front short bottom strip  
Qty: 1

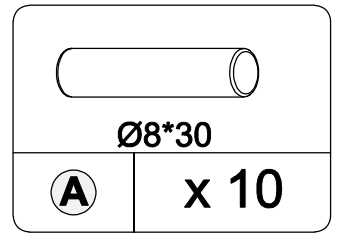

**A** x 10

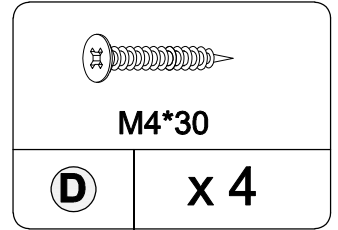

**D** x 4

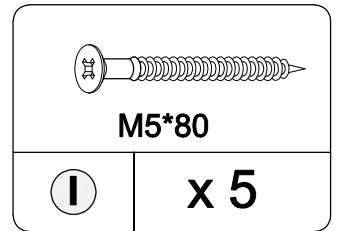

**I** x 5

1. Connect with hardware A first, then install with hardware D, I

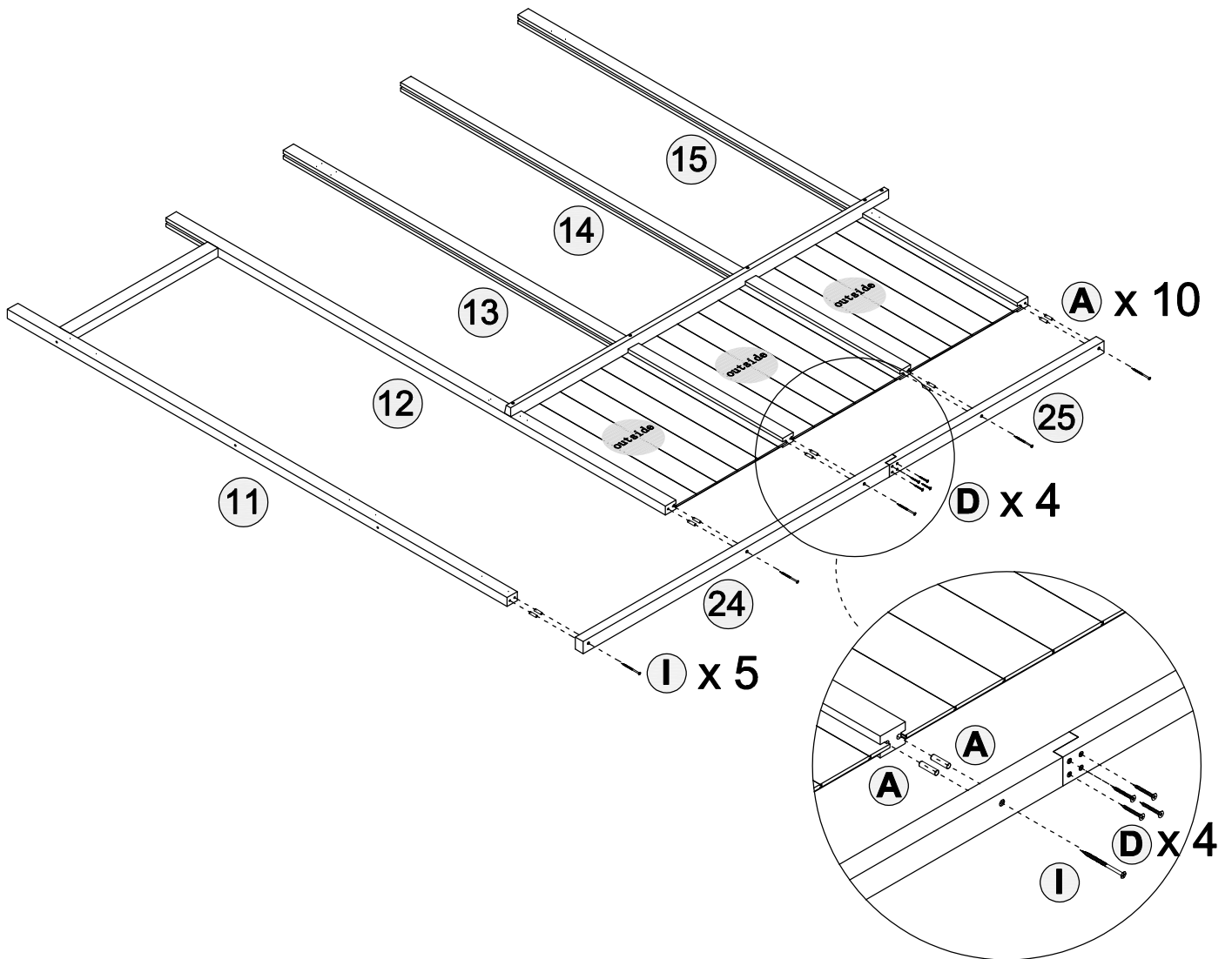

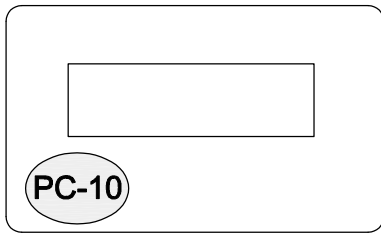
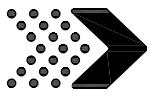

**PC-10**  
Sunshine board on the door  
Qty: 1

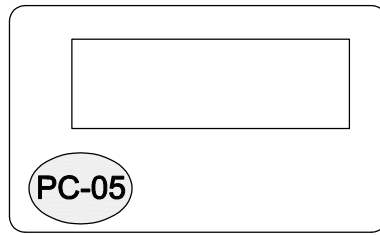

**PC-05**  
Front Sunlight Panel  
Qty: 3

1. Place components PC-05 and PC-10 into the slot
2. Before installing component , insert the guide plate into the slot to align the slot
3. Before installing each PC component, the film should be peeled off first

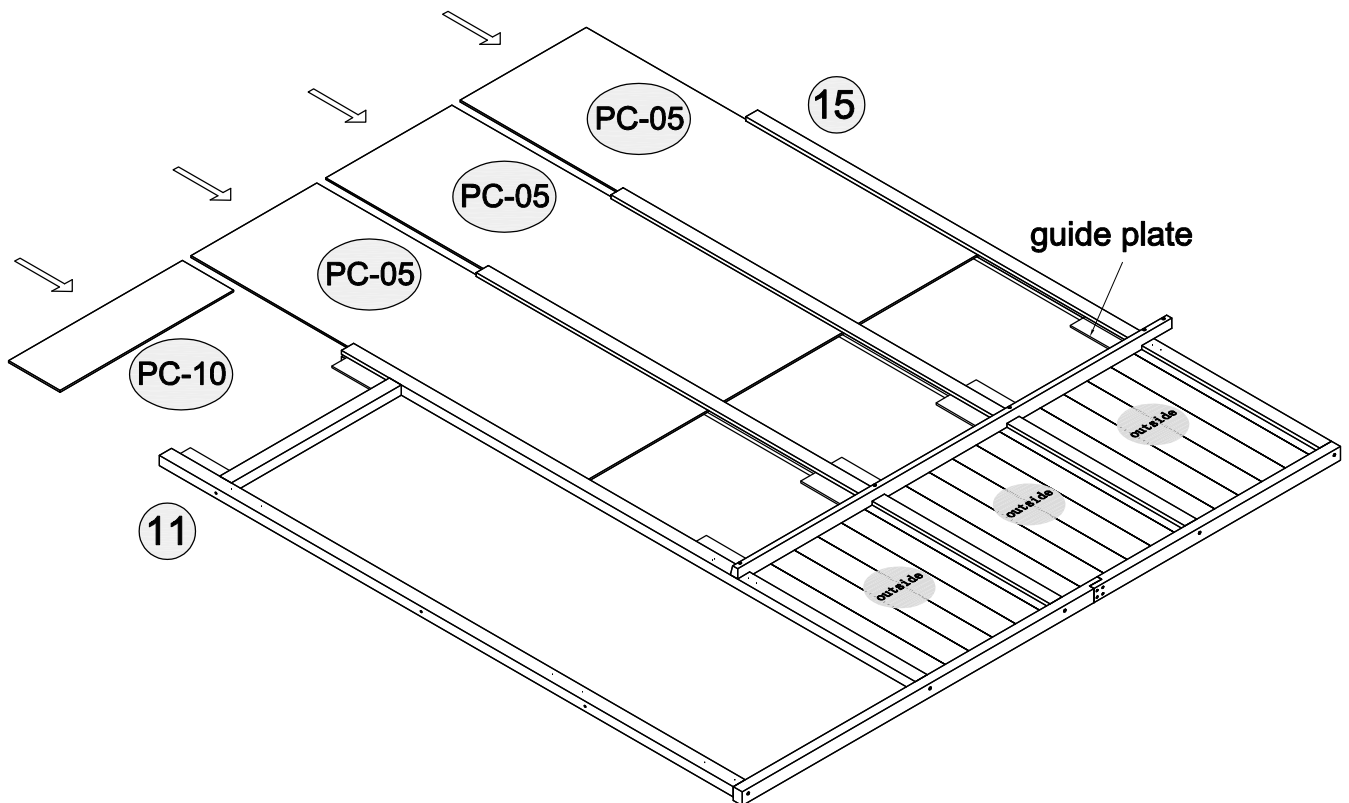

The 2 guide spacers need to be moved to the other side for position when one side is secured.

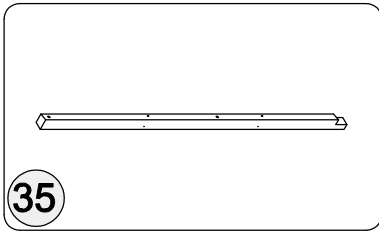
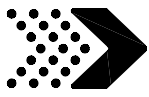

Front long beam  
Qty: 1

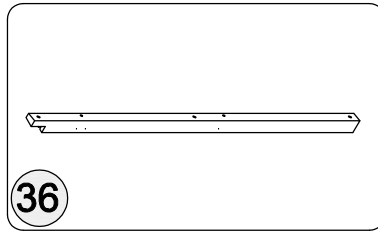

Front short beam  
Qty: 1

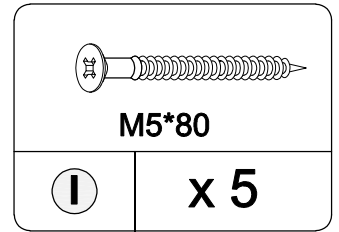
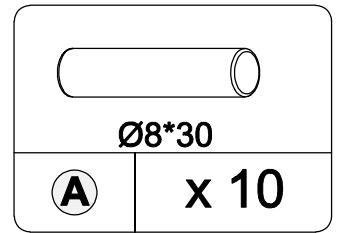

1. Connect with hardware A first, then install with hardware I

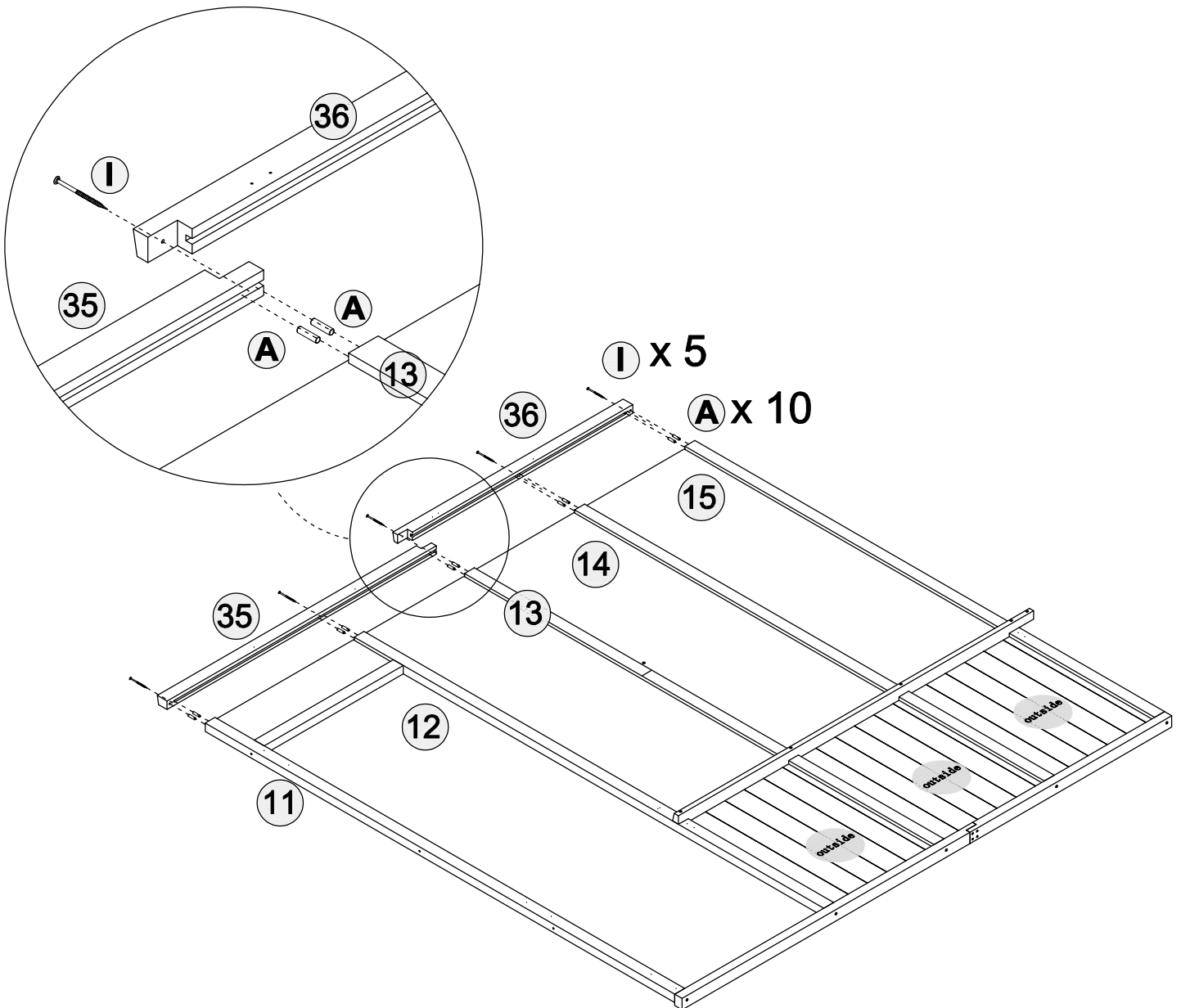



door stop  
Qty: 1

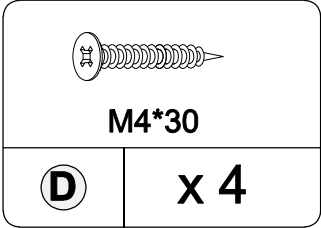

1. Use hardware D to pass through component 56 and install it towards the lead hole

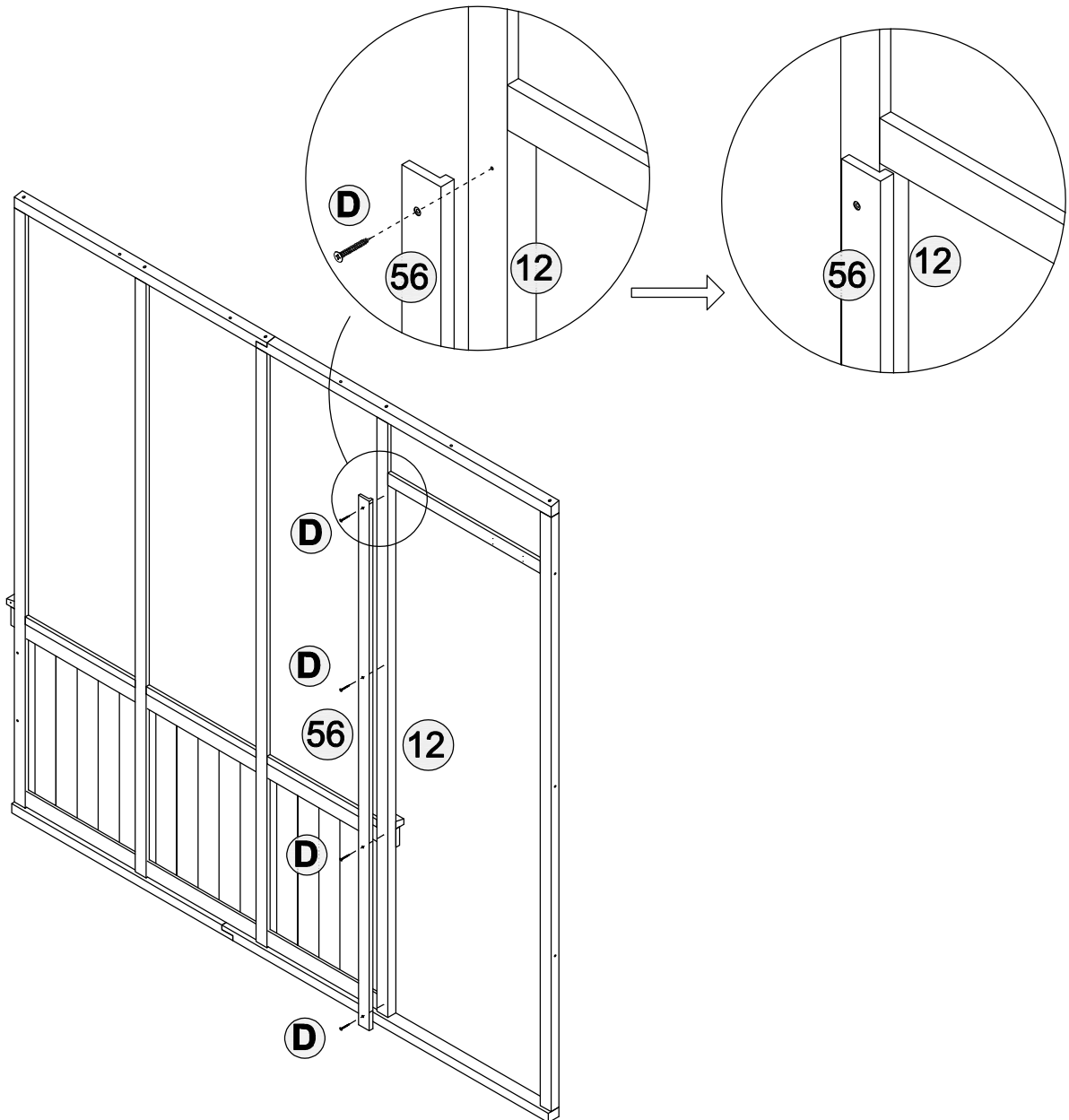

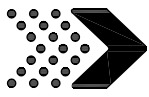

It is recommended to first locate and gather all the parts according to this diagram, which will facilitate quick installation later.

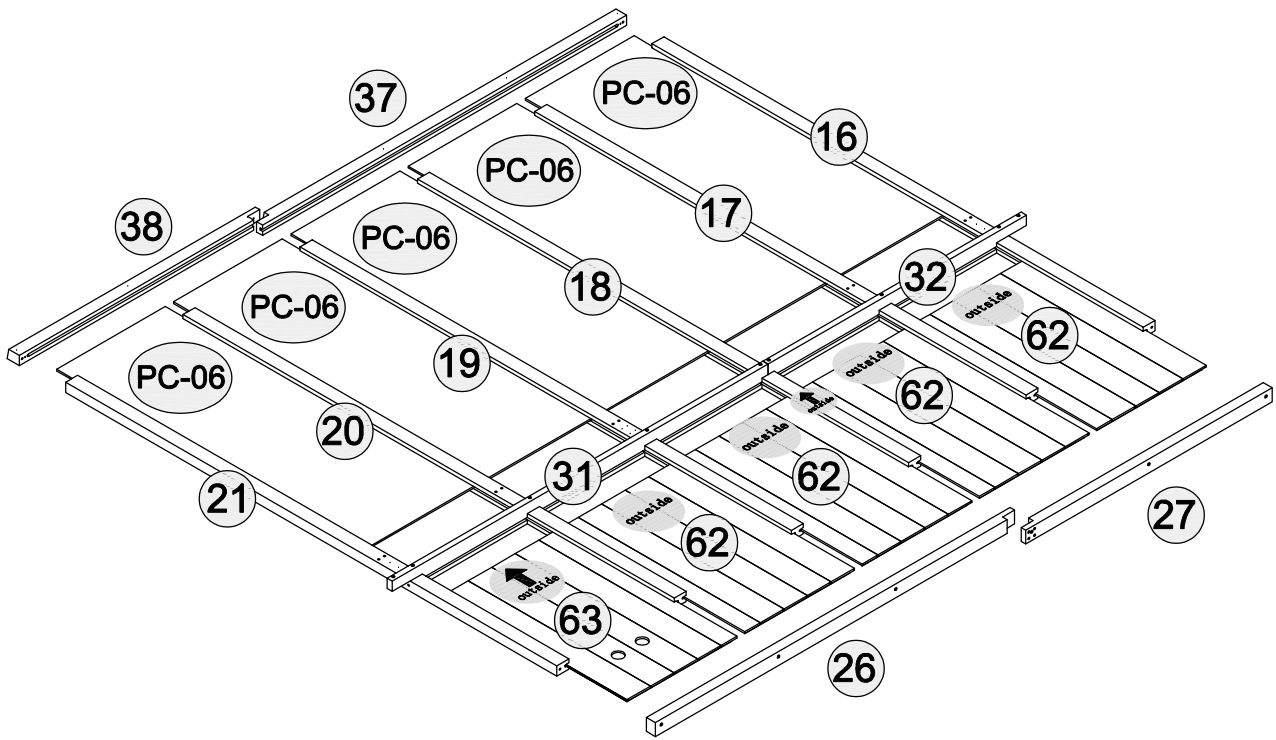

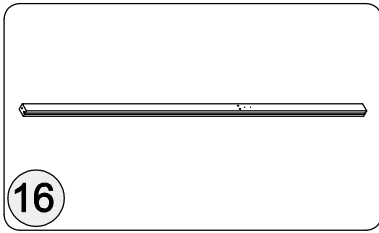
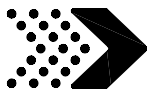

**16**  
Rear left pillar  
Qty: 1

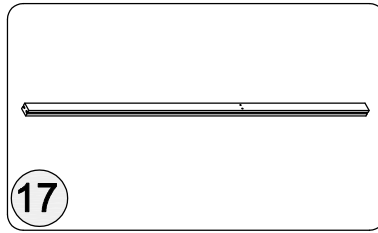

**17**  
Rear center pillar  
Qty: 1

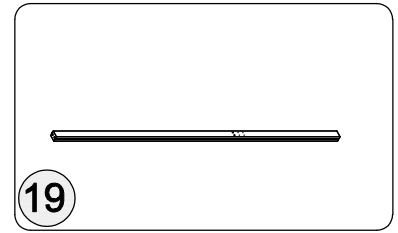

**19**  
Rear center pillar  
Qty: 1

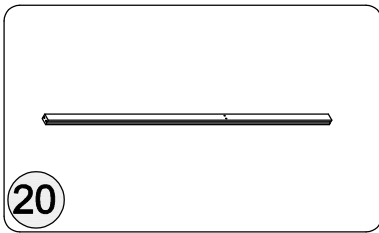

**20**  
Rear center pillar  
Qty: 1

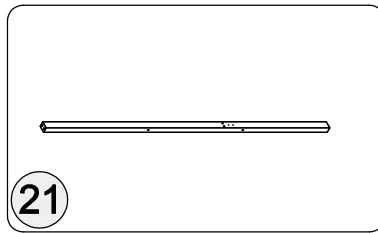

**21**  
Rear right pillar  
Qty: 1

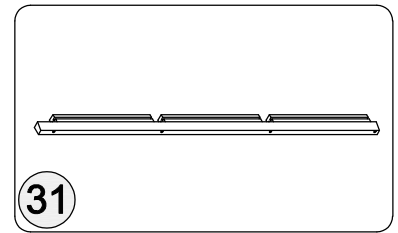

**31**  
Rear middle strip  
Qty: 1

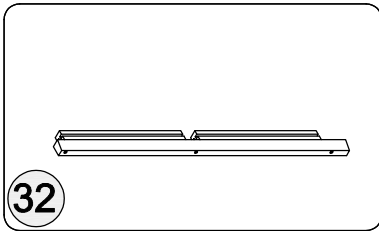

**32**  
Rear middle short strip  
Qty: 1

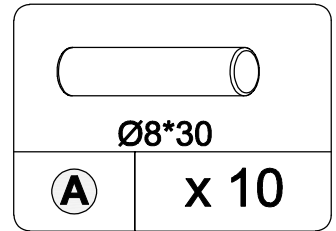

1. Connect with hardware A first

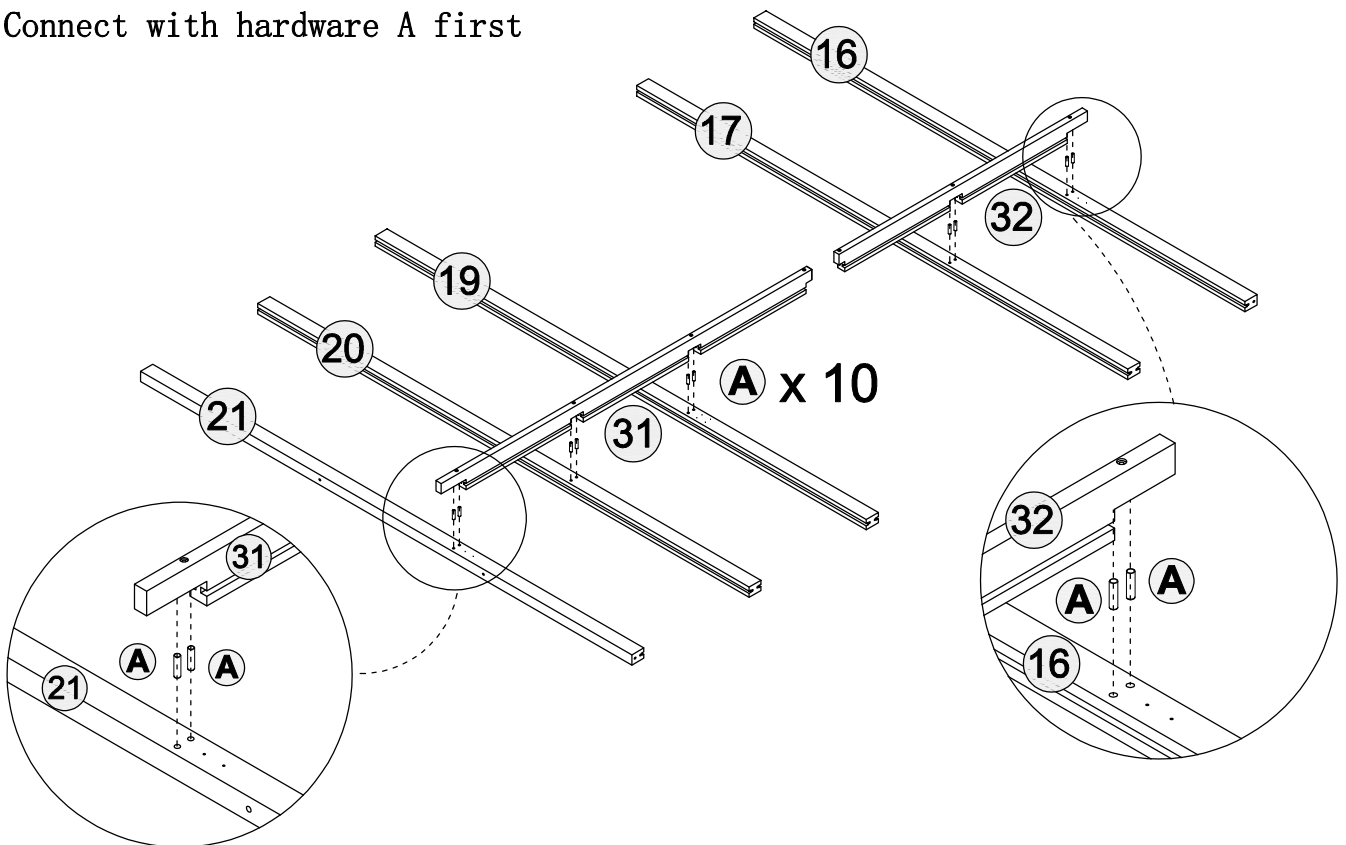

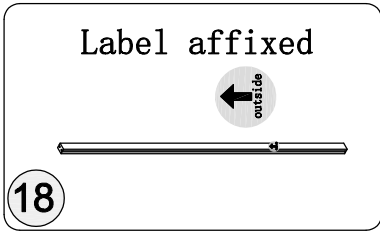
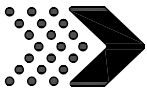

**18**  
Rear center pillar  
Qty: 1

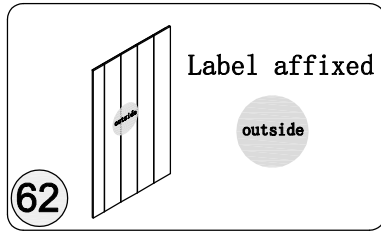

**62**  
Rear core board  
Qty: 4

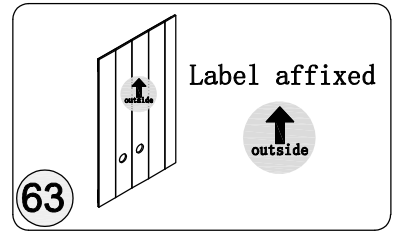

**63**  
Rear core board  
Qty: 1

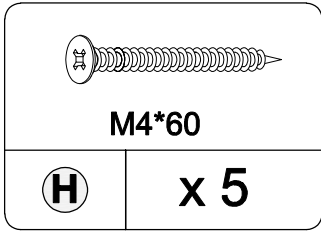

1. Component 18 is placed below components 31 and 32, Don't install the hardware yet
2. Before installing component , insert the guide plate into the slot to align the slot
3. Place the 62,63-side plate into the side slot

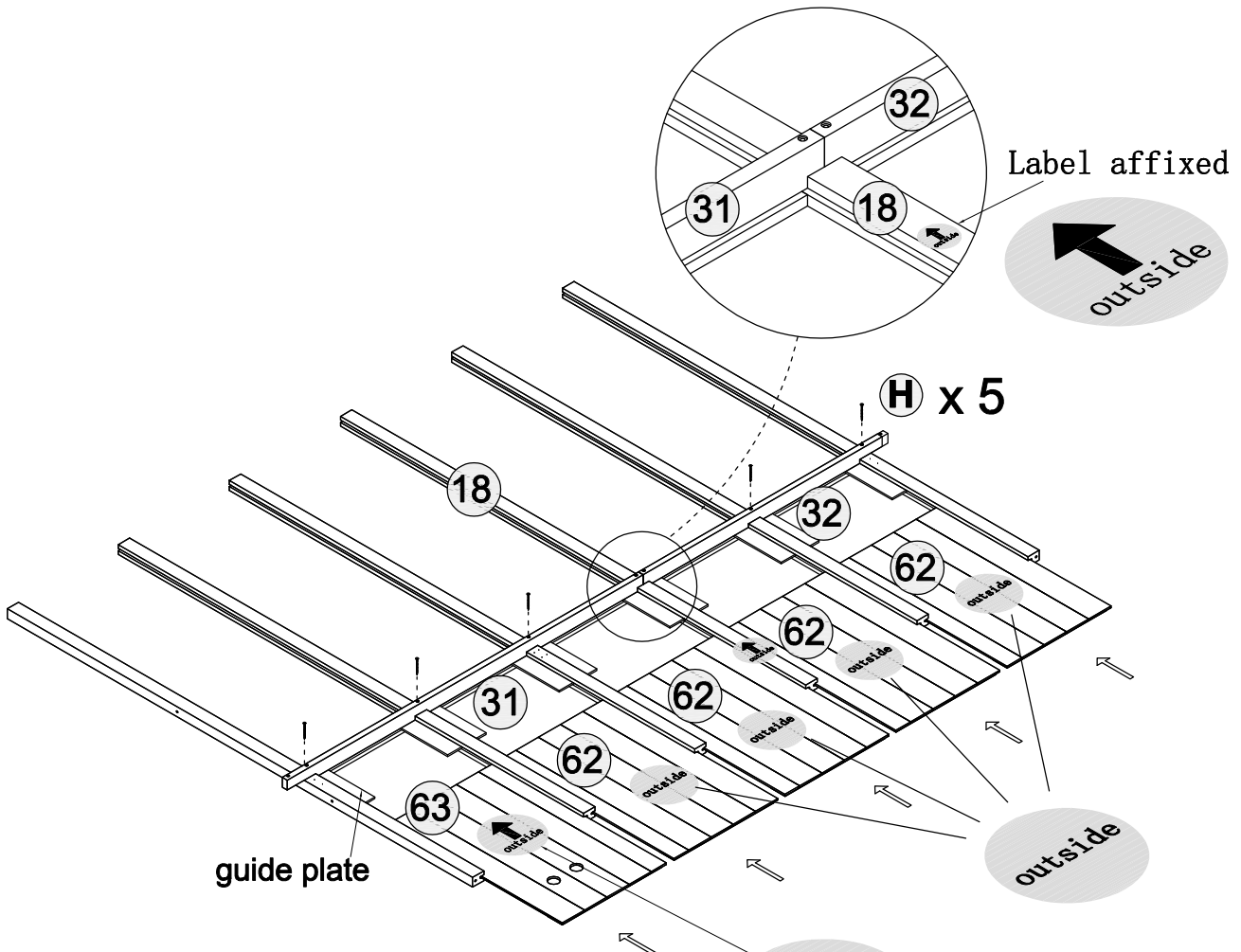

The 2 guide spacers need to be moved to the other side for position when one side is secured.

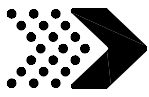

# Rear frame installation

## Step 12

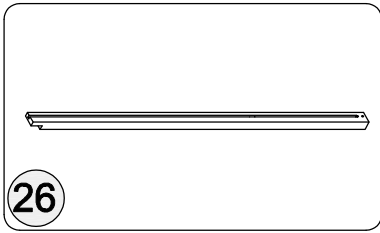

**26**  
Rear long bottom strip  
Qty: 1

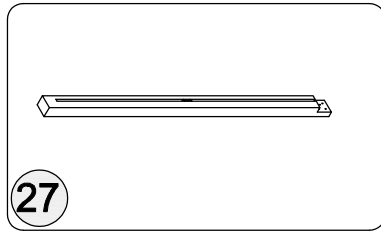

**27**  
Rear short bottom strip  
Qty: 1

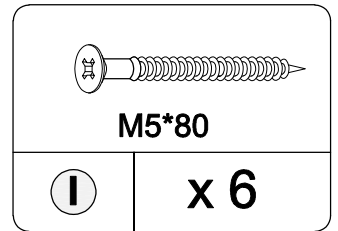
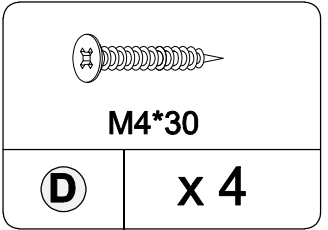
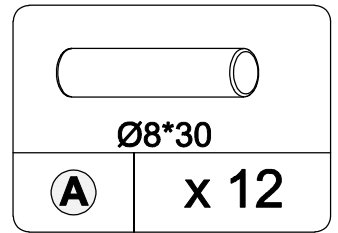

1. Connect with hardware A first, then install with hardware D, I

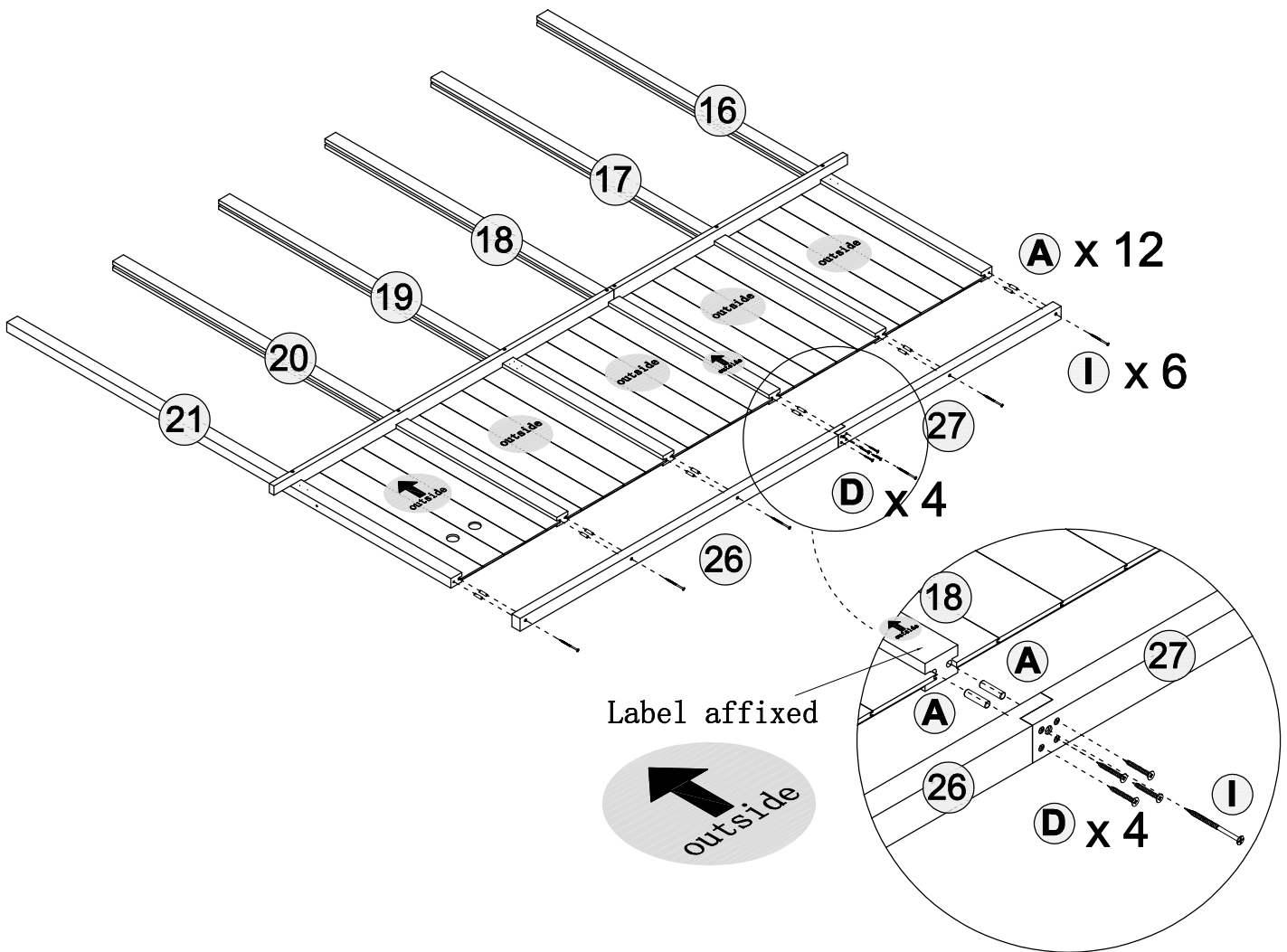

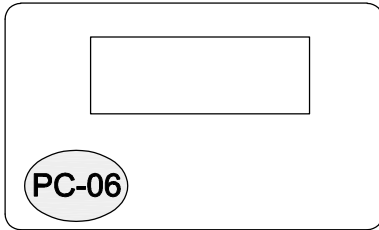

PC-06

Rear sunlight panel  
Qty: 5



M4\*60

H

x 2

1. Connect with hardware H
2. Before installing component PC-06 , insert the guide plate into the slot to align the slot
3. Before installing each PC component, the film should be peeled off first

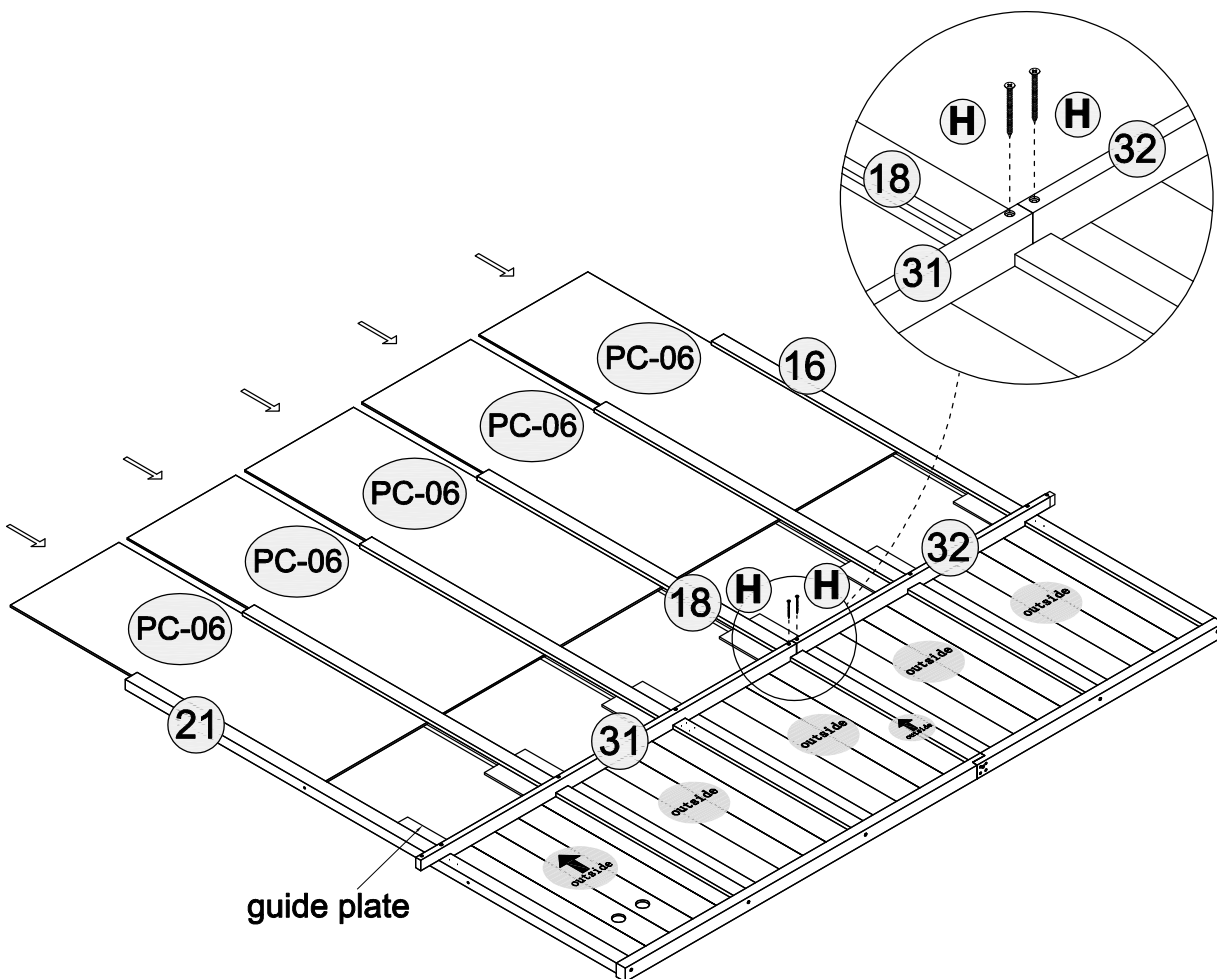

The 2 guide spacers need to be moved to the other side for position when one side is secured.

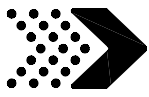

# Rear frame installation

Step 14

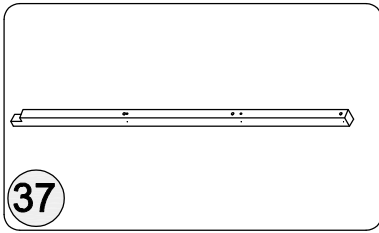

Rear long beam  
Qty: 1

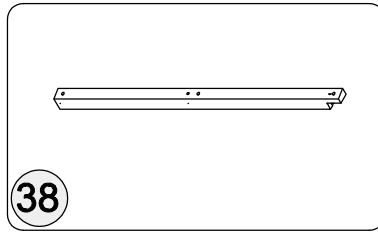

Rear short beam  
Qty: 1

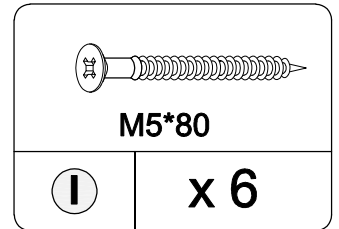
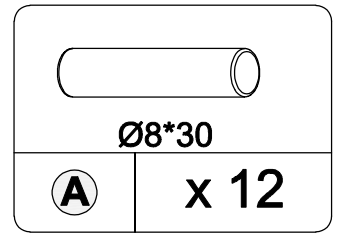

1. Connect with hardware A first, then install with hardware I

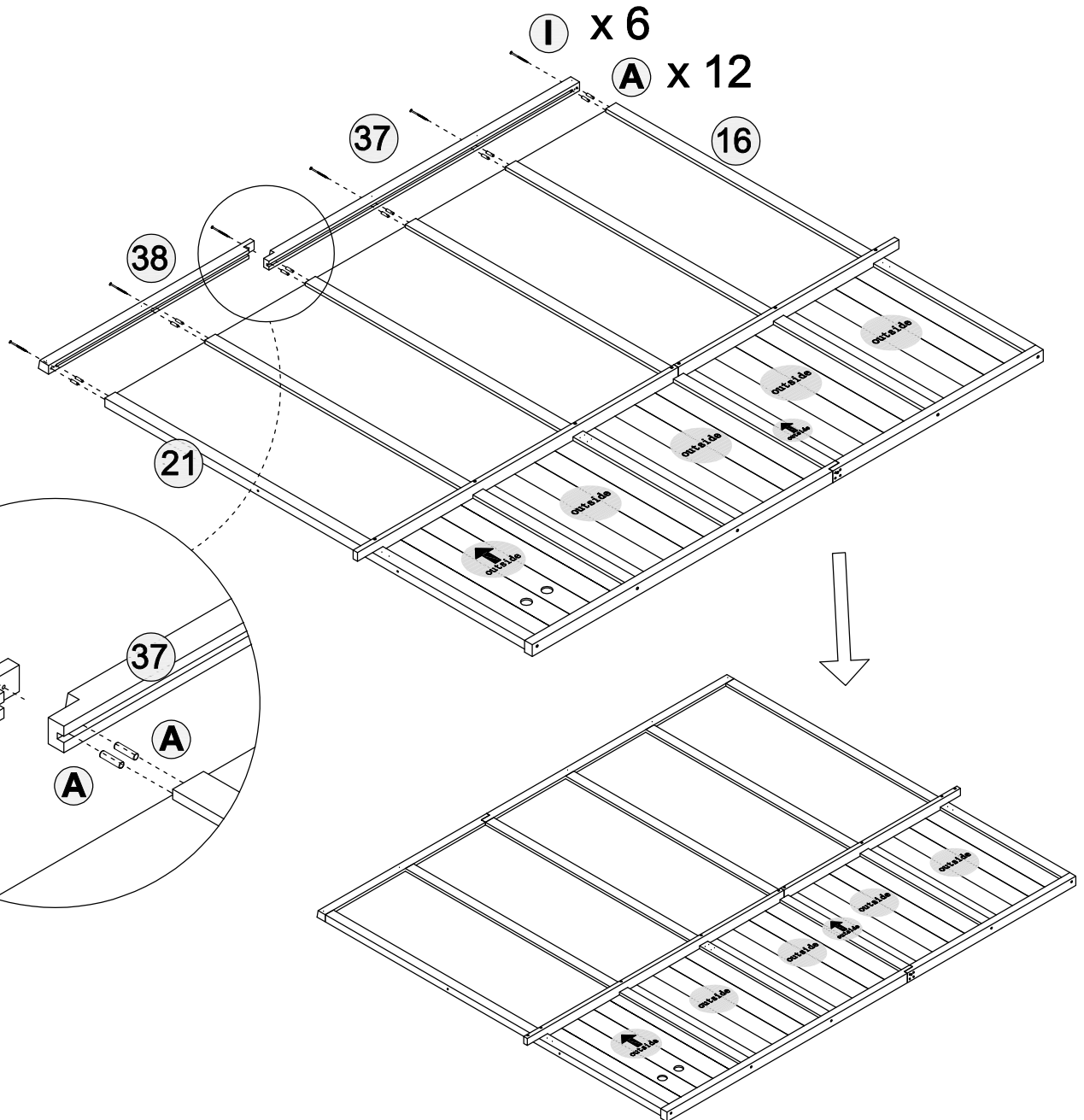

Effect after installation

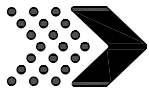

It is recommended to first locate and gather all the parts according to this diagram, which will facilitate quick installation later.

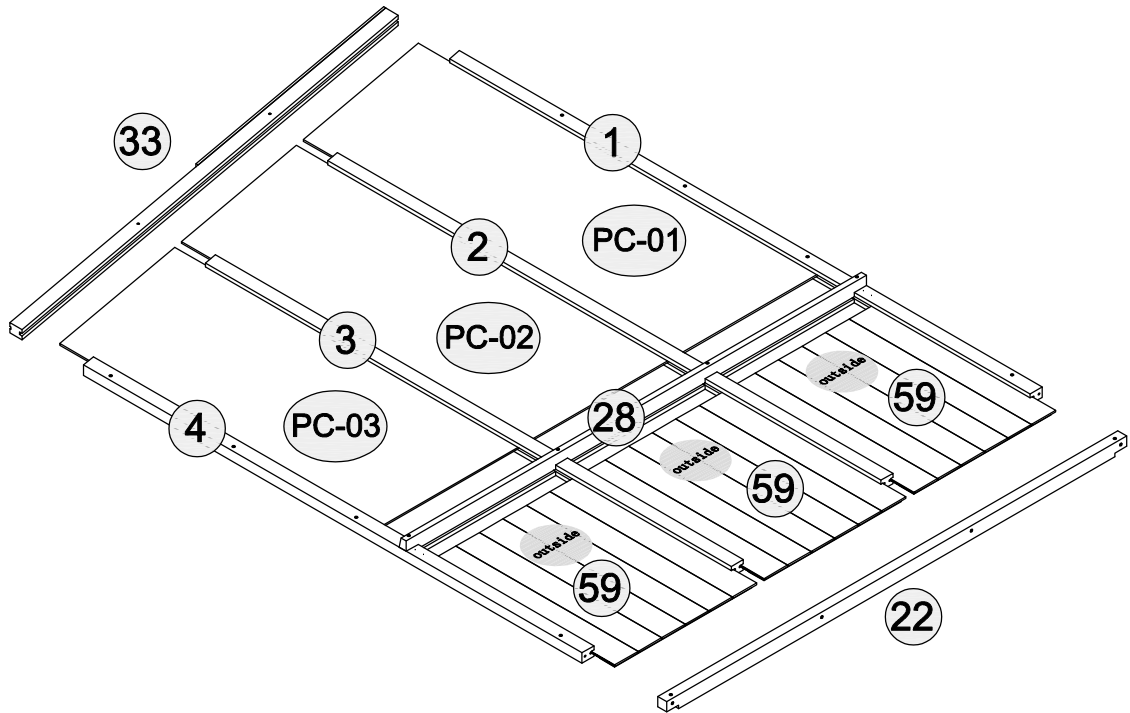

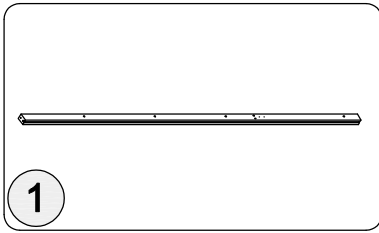
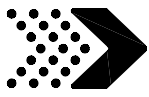

1

Left front pillar  
Qty: 1

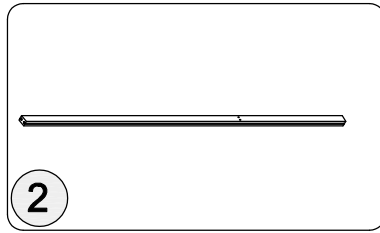

2

Left center pillar  
Qty: 1

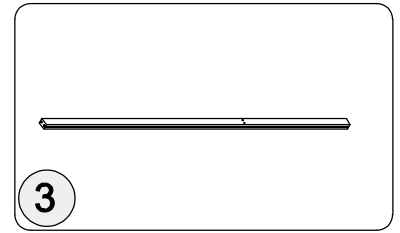

3

Left center pillar  
Qty: 1

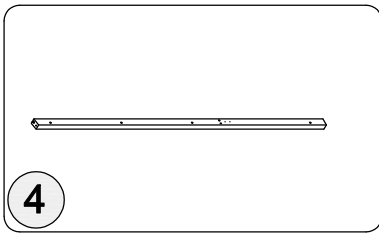

4

Left rear pillar  
Qty: 1

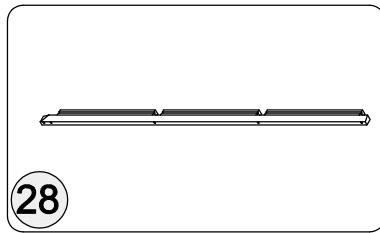

28

Left middle bar  
Qty: 1

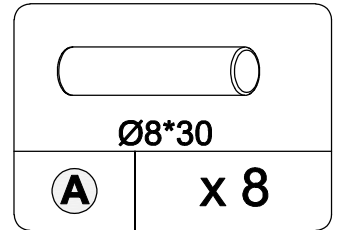

A

x 8

1. Connect with hardware A first

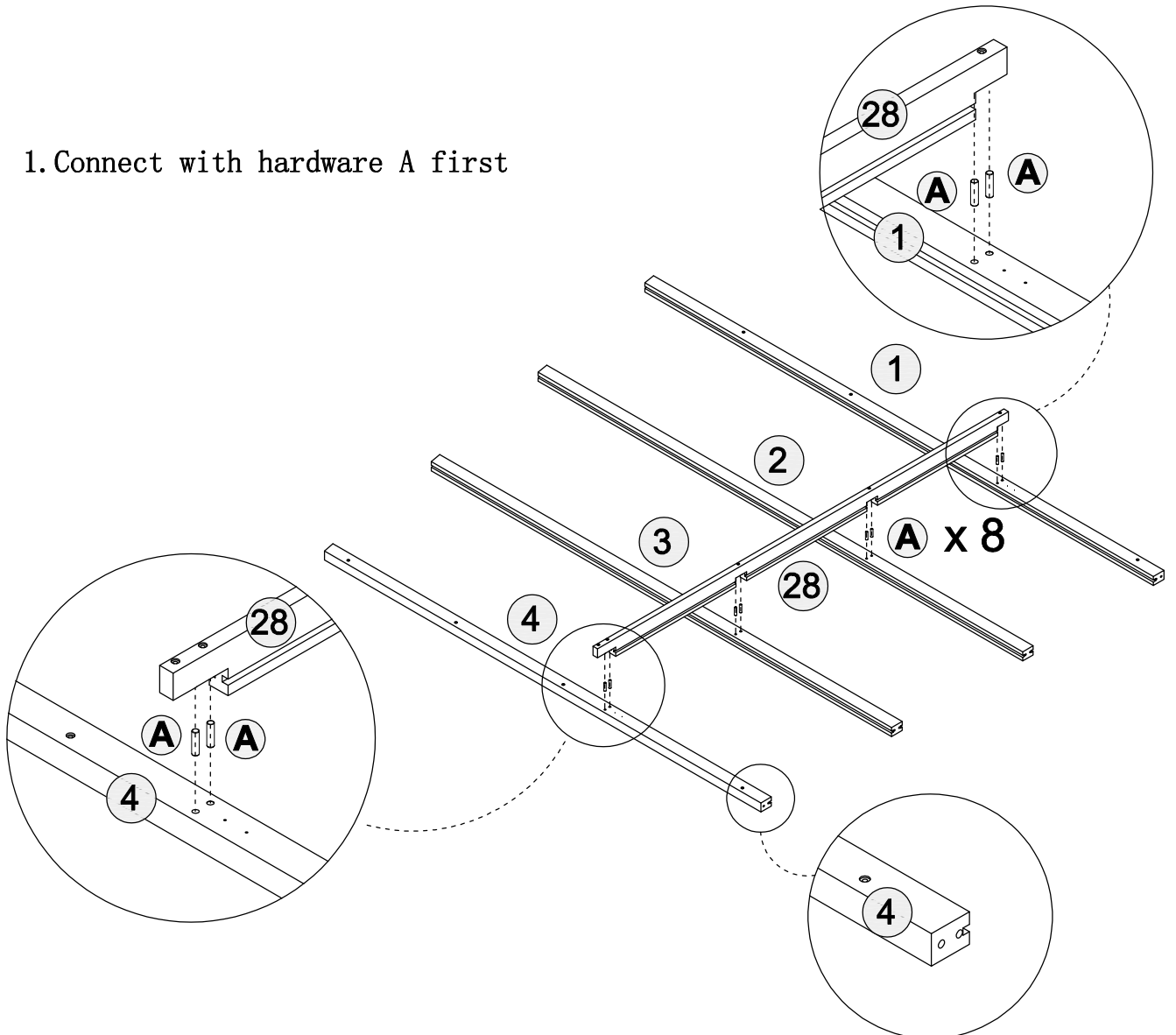

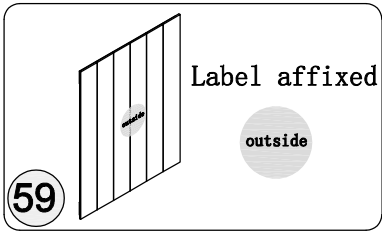

Side core board  
Qty: 3

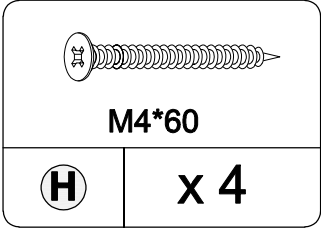

1. Connect with hardware H
2. Before installing component 59, insert the guide plate into the slot to align the slot
3. Place the 59-side plate into the side slot

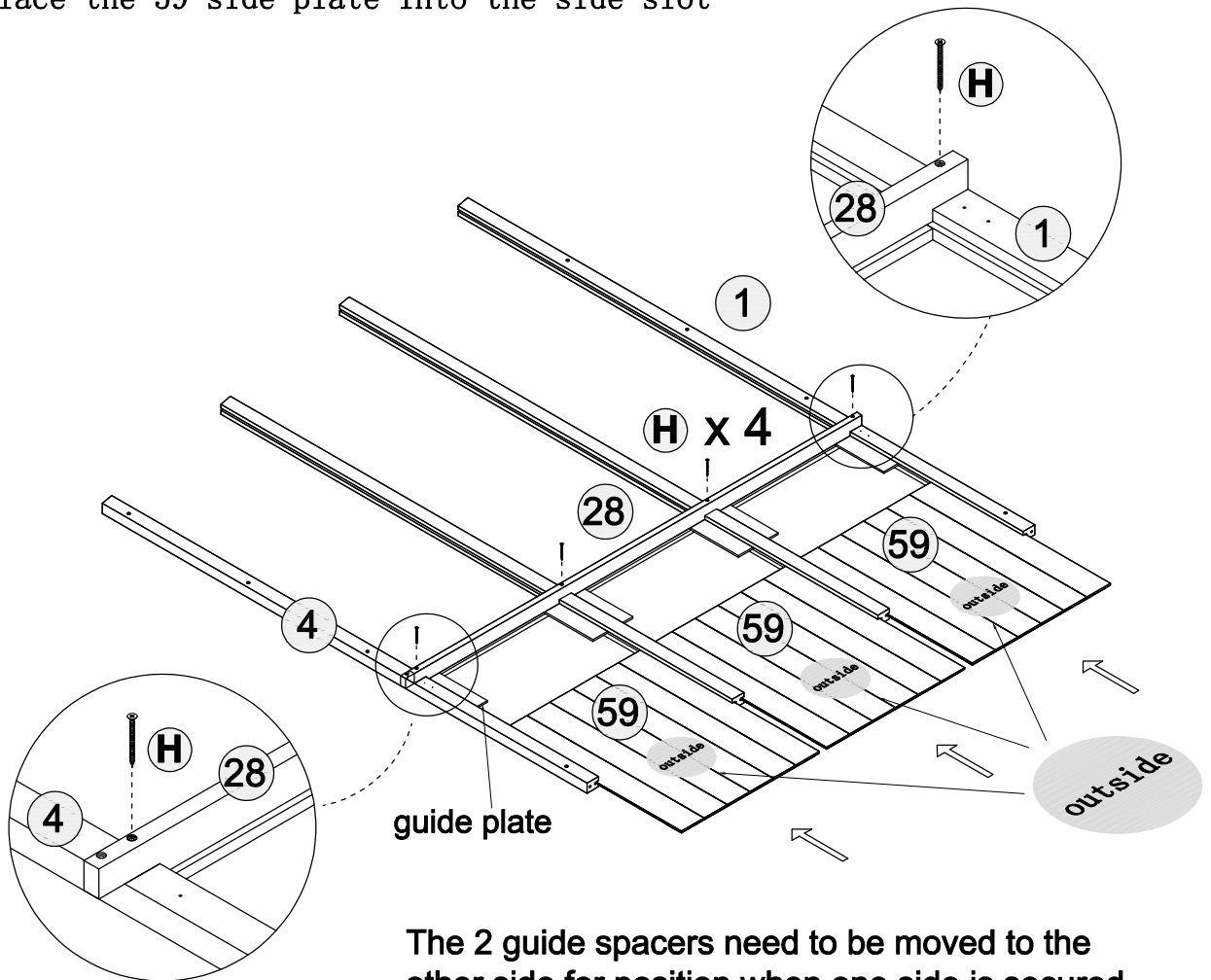

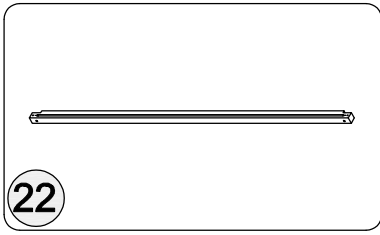
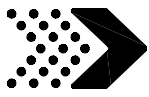

Side bottom Flat noodles  
Qty: 1

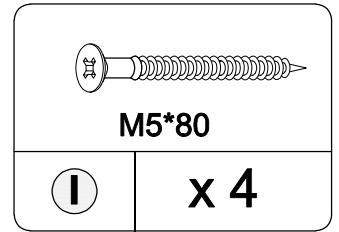
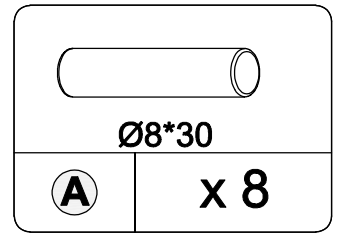

1. Connect with hardware A first, then install with hardware I

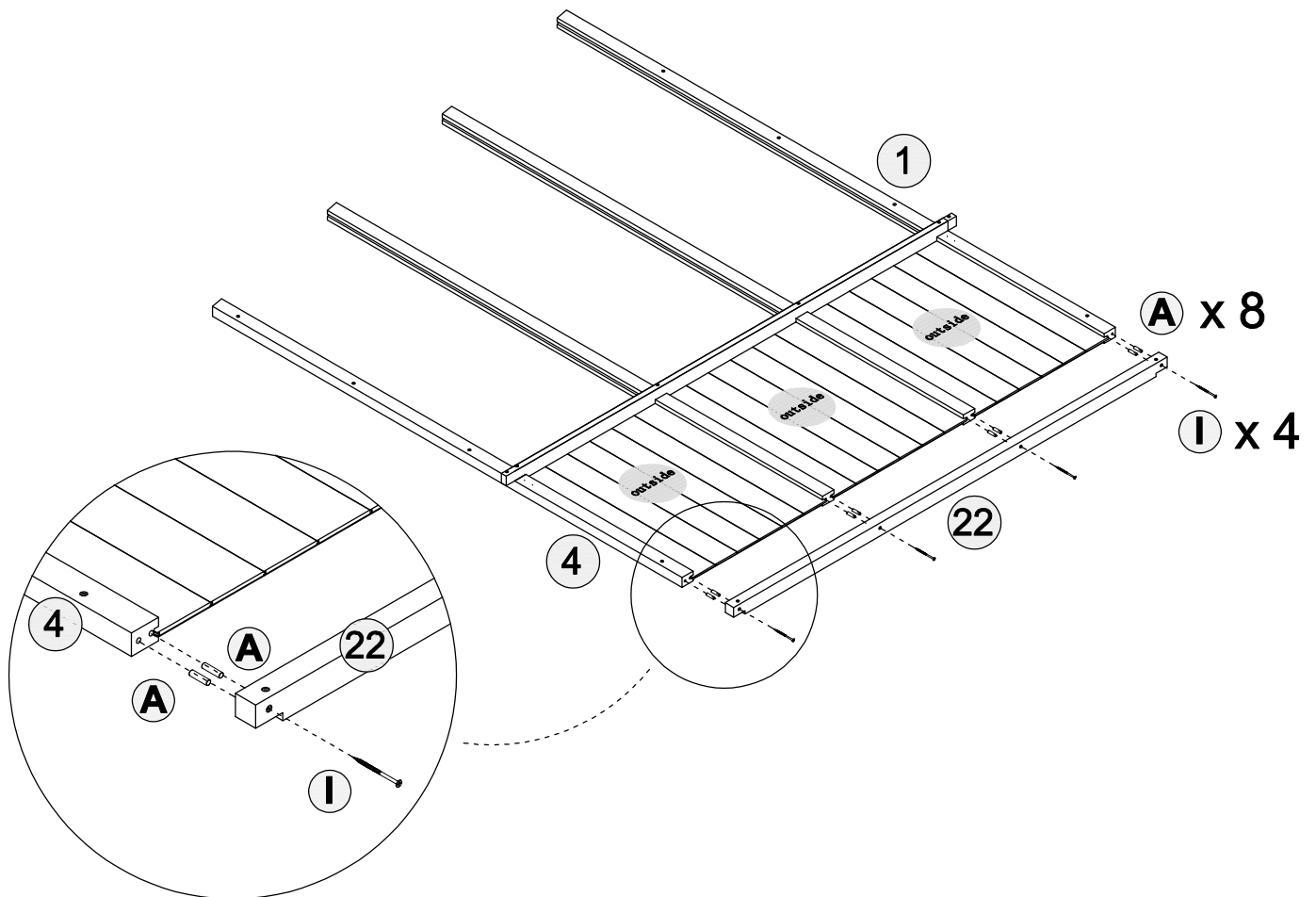

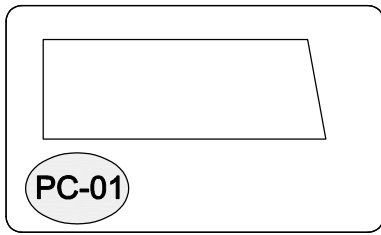
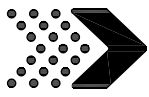

**Front Sunlight Panel**  
Qty: 1

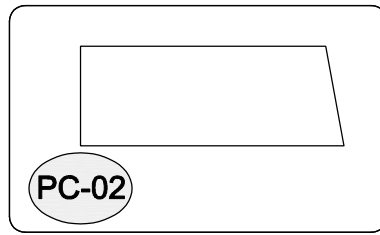

**Sunlight panel**  
Qty: 1

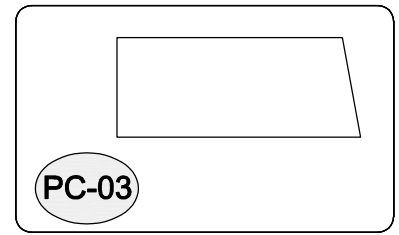

**Rear sunlight panel**  
Qty: 1

1. Before installing component , insert the guide plate into the slot to align the slot
2. Place components PC-01, PC-02, and PC-03 into the slot
3. Before installing each PC component, the film should be peeled off first

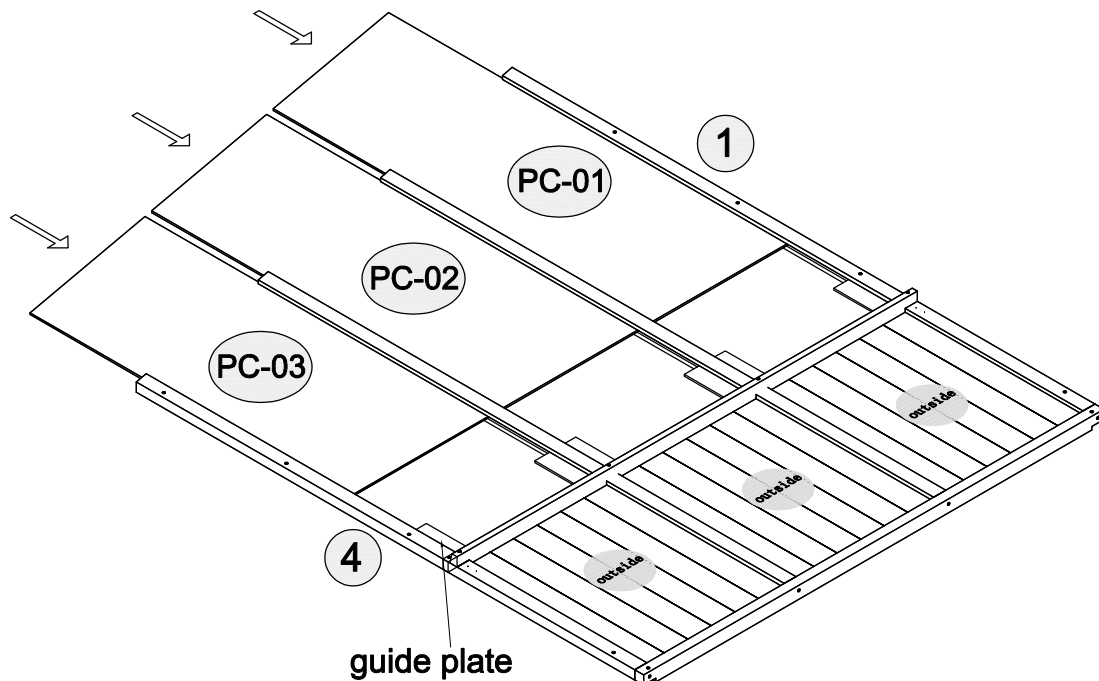

The 2 guide spacers need to be moved to the other side for position when one side is secured.

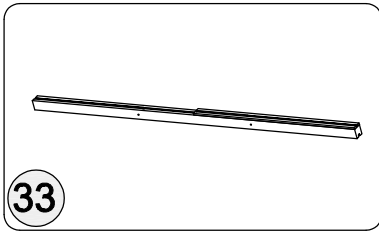
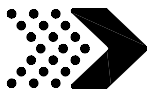

Left side beam

Qty: 1

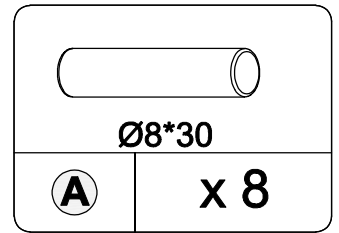

Ø8\*30

A

x 8

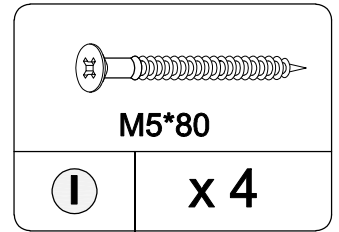

M5\*80

I

x 4

1. Connect with hardware A first, then install with hardware I

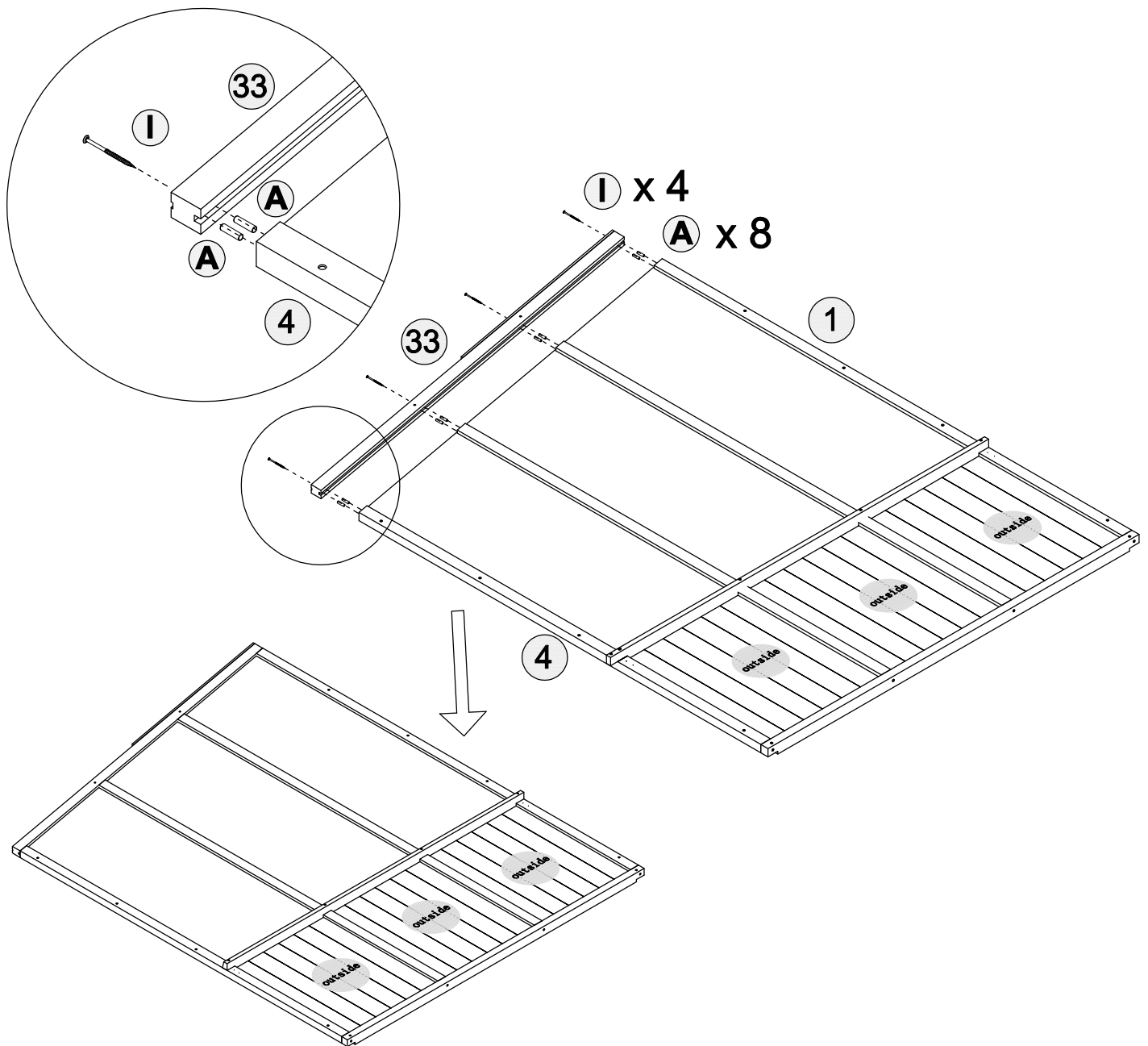

Effect after installation

It is recommended to first locate and gather all the parts according to this diagram, which will facilitate quick installation later.

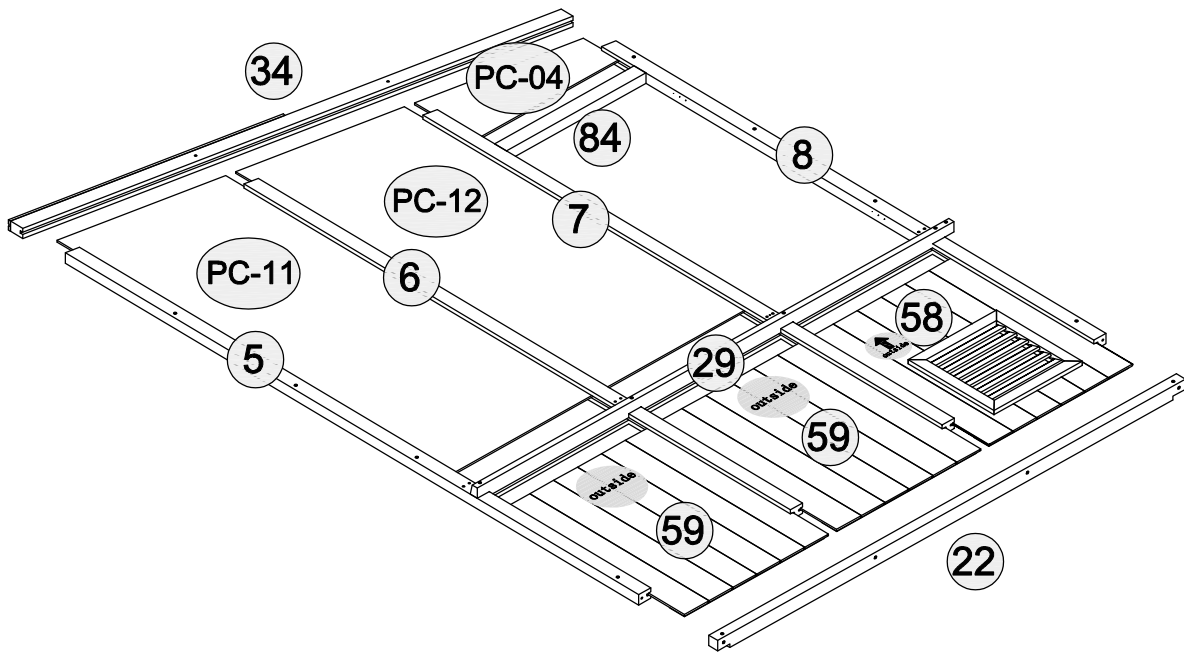

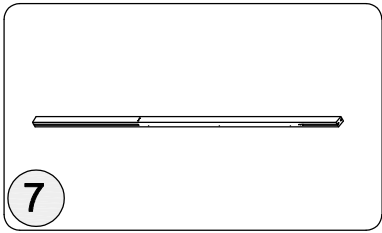

**7**  
Right center pillar  
Qty: 1

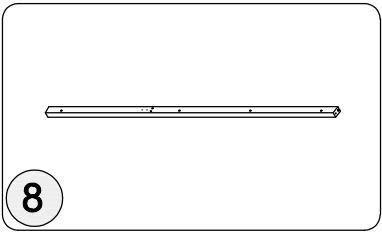

**8**  
Right rear pillar  
Qty: 1

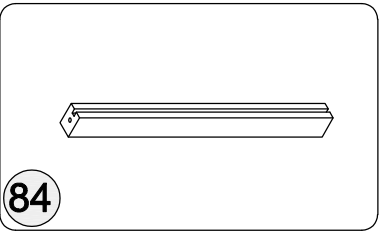

**84**  
Noodles on the window  
Qty: 1

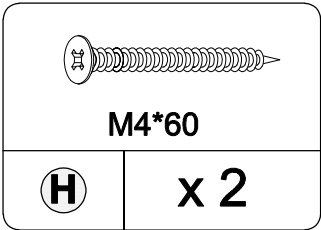
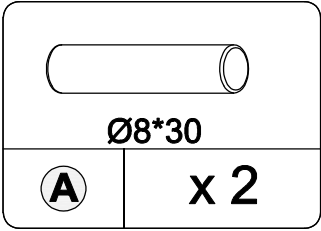

1. Connect with hardware A first, then install with hardware H

 2. Note that slot 84 is facing upwards

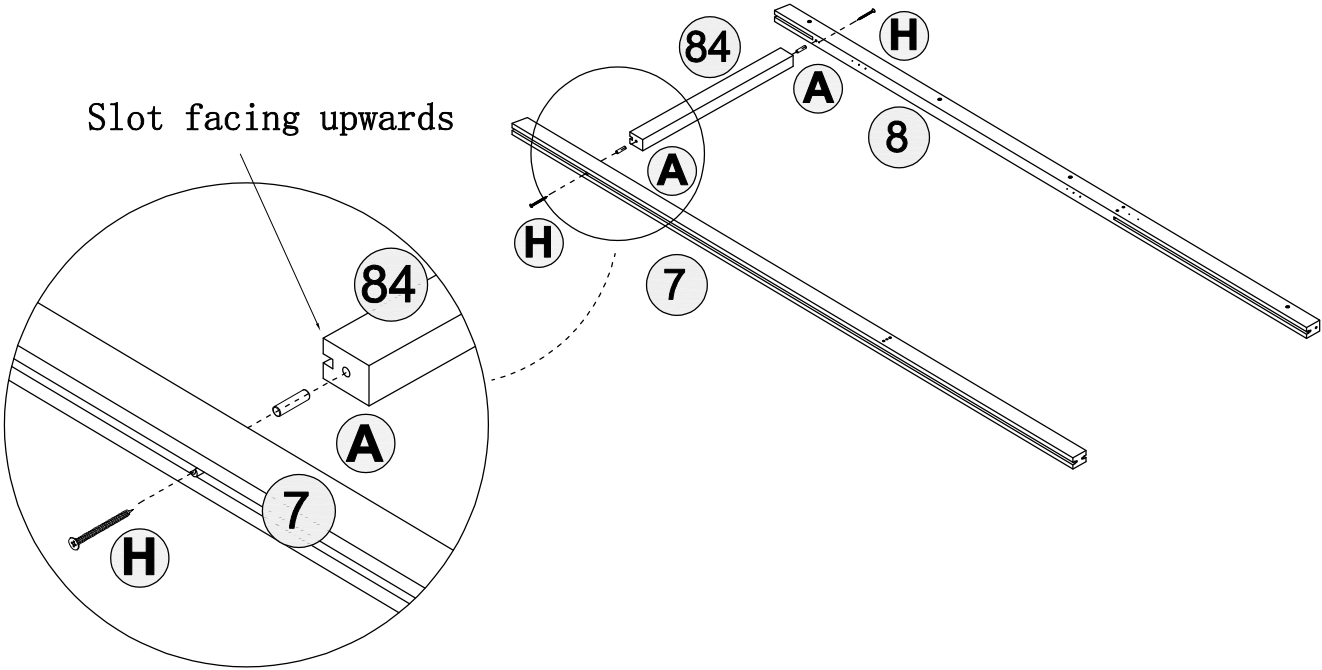

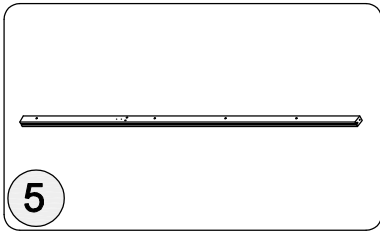
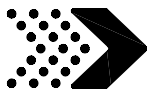

**5**  
Right front pillar  
Qty: 1

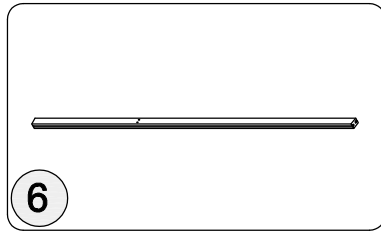

**6**  
Right center pillar  
Qty: 1

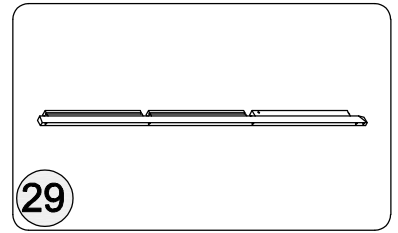

**29**  
Right middle bar  
Qty: 1

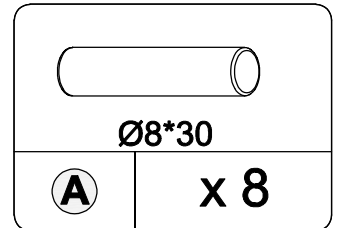

1. Connect with hardware A first

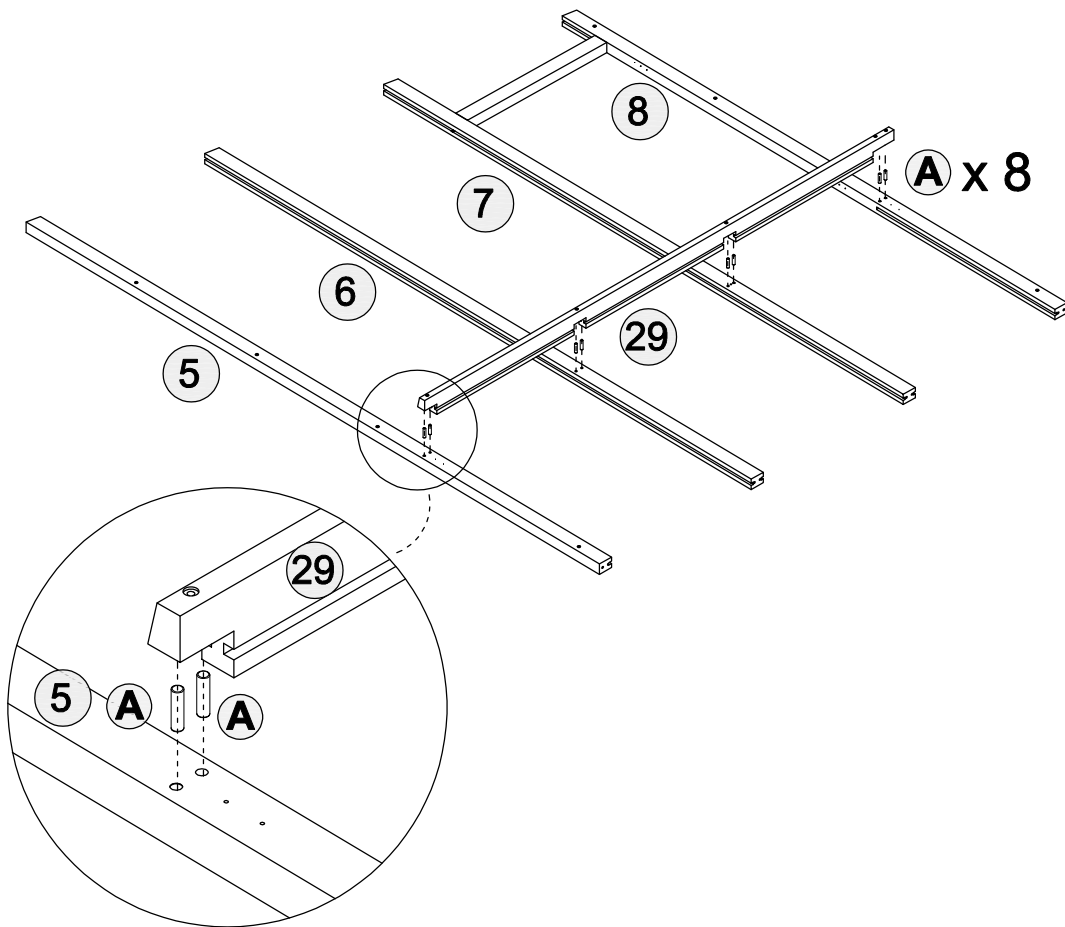

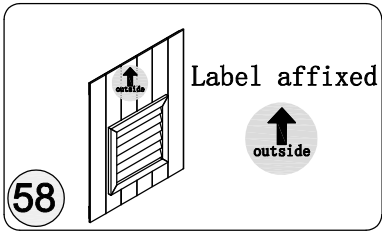

**58**  
Side core board  
Qty: 1

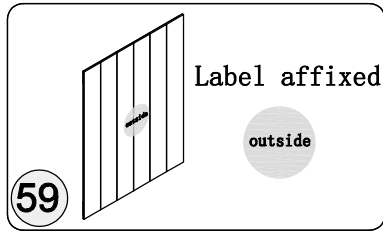

**59**  
Side core board  
Qty: 2

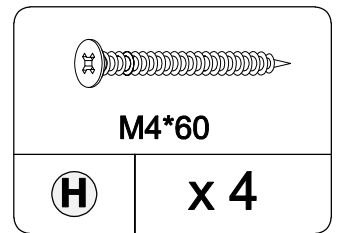

1. Connect with hardware H
2. Before installing component 58, 59, insert the guide plate into the slot to align the slot
3. Place the 58, 59-side plate into the side slot

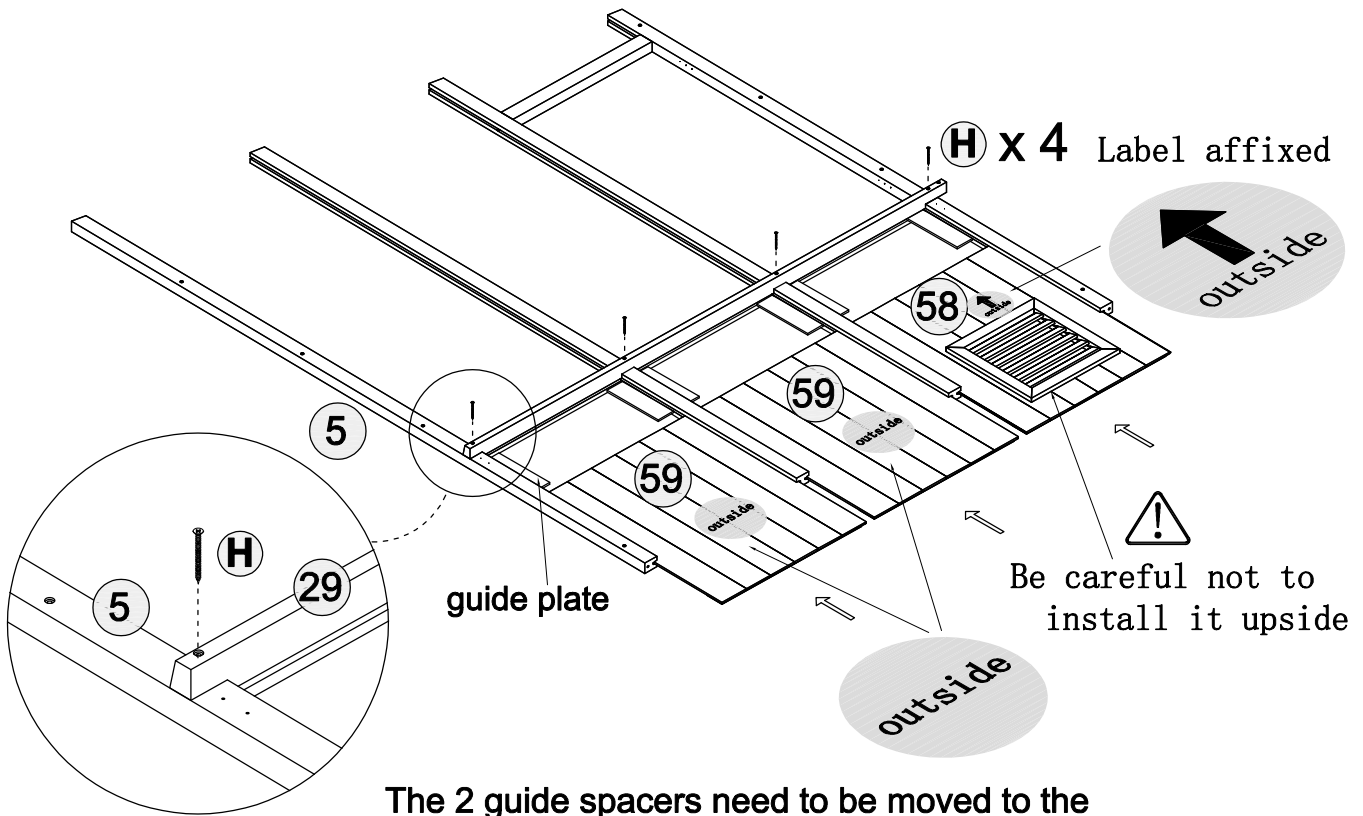

The 2 guide spacers need to be moved to the other side for position when one side is secured.

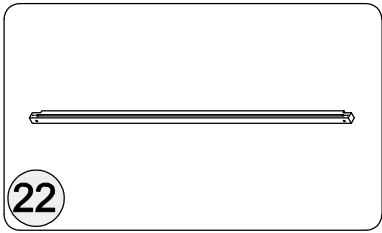

Side bottom Flat noodles  
Qty: 1

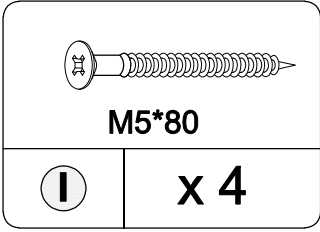
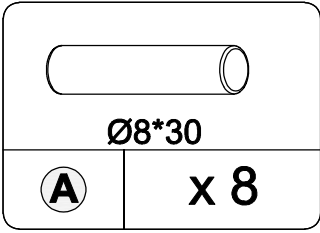

1. Connect with hardware A first, then install with hardware I

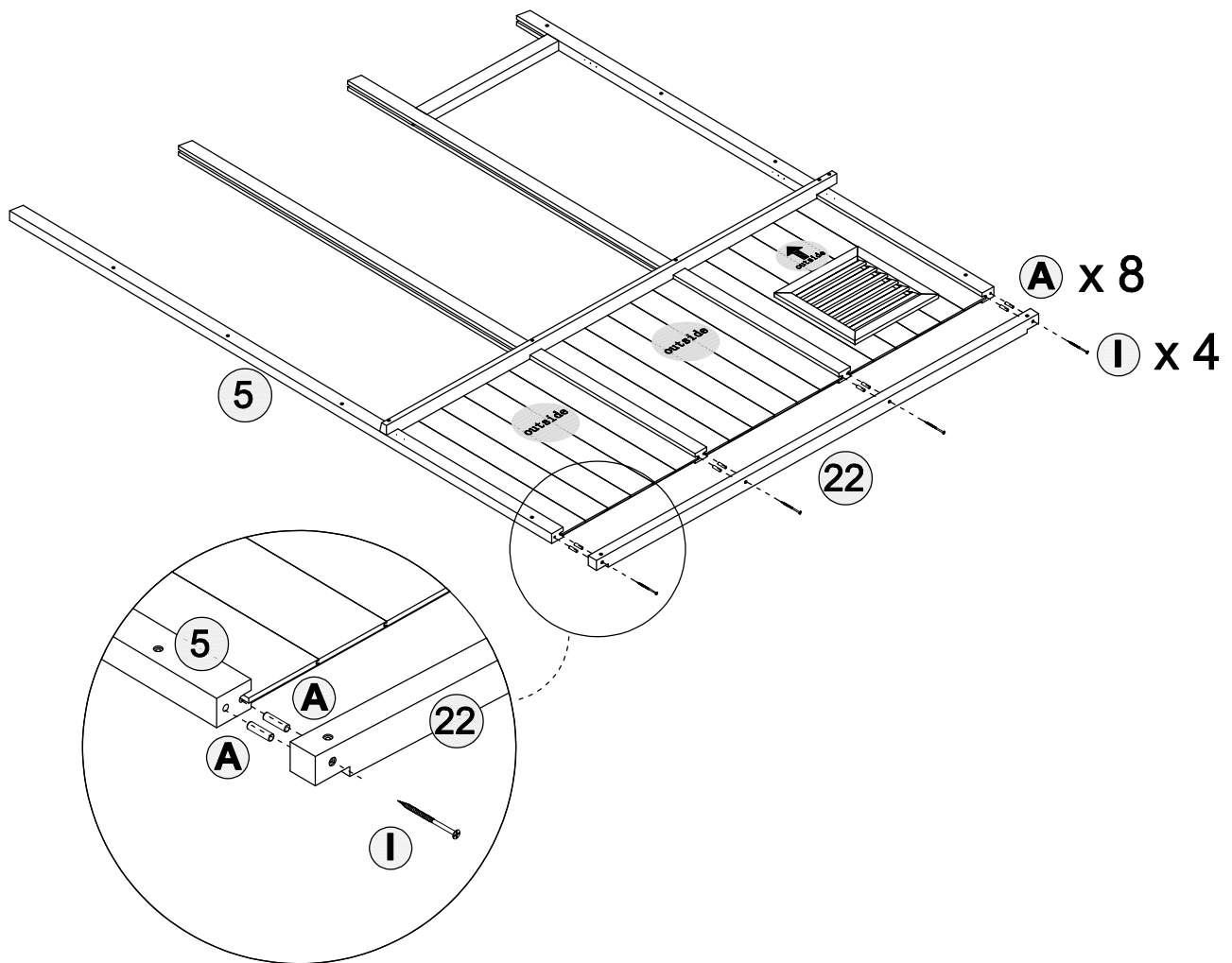

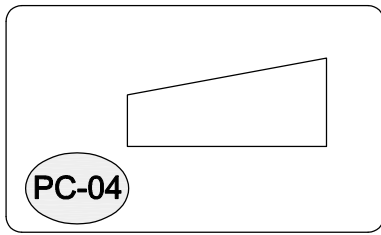
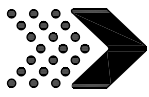

Rear sunlight panel  
Qty: 1

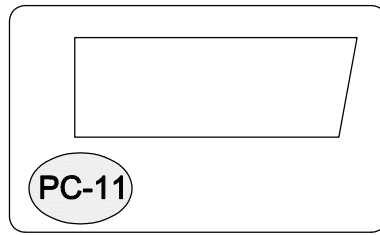

Side sunlight panel  
Qty: 1

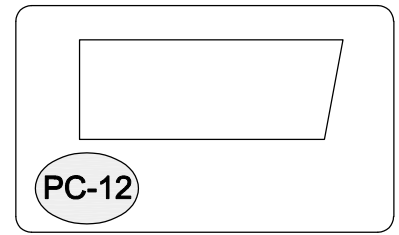

Side sunlight panel  
Qty: 1

1. Before installing component , insert the guide plate into the slot to align the slot
2. Place components PC-04, PC-11, and PC-12 into the slot
3. Before installing each PC component, the film should be peeled off first

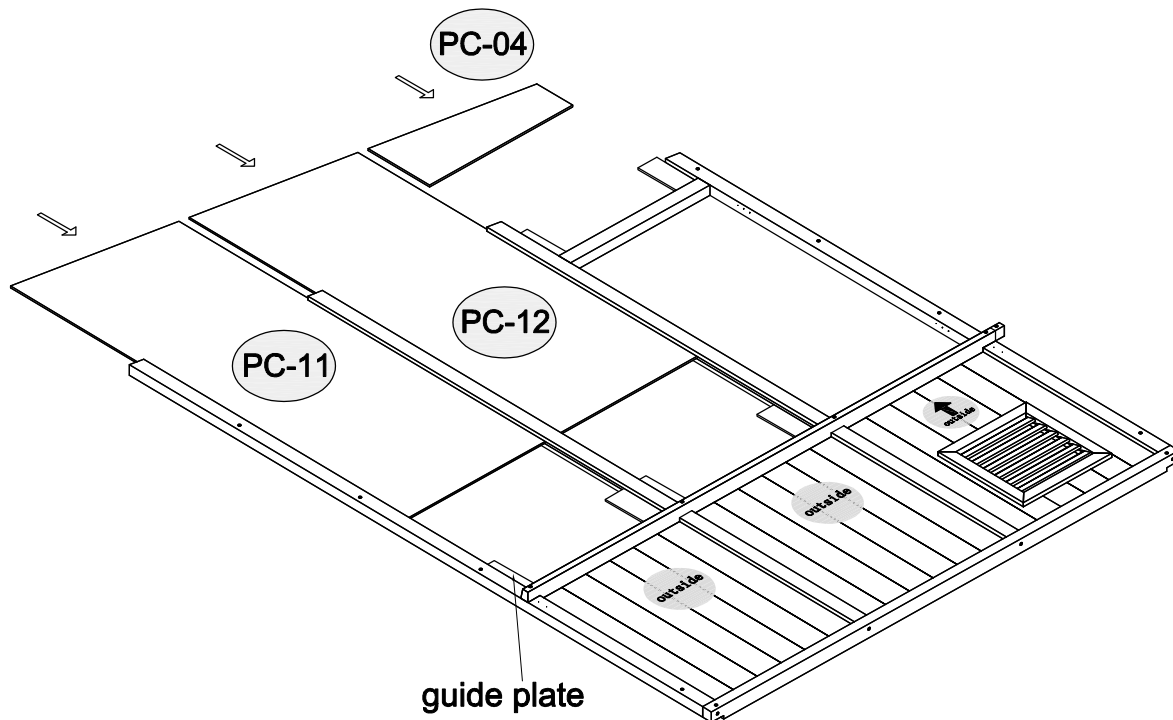

The 2 guide spacers need to be moved to the other side for position when one side is secured.

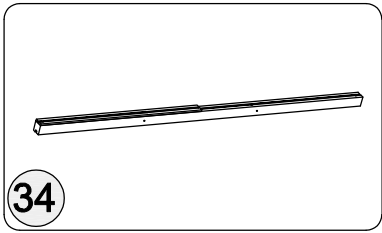

Right side beam  
Qty: 1

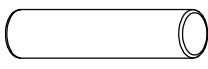
	
Ø8*30	
<b>A</b>	<b>x 8</b>

	
M5*80	
<b>I</b>	<b>x 4</b>

1. Connect with hardware A first, then install with hardware I

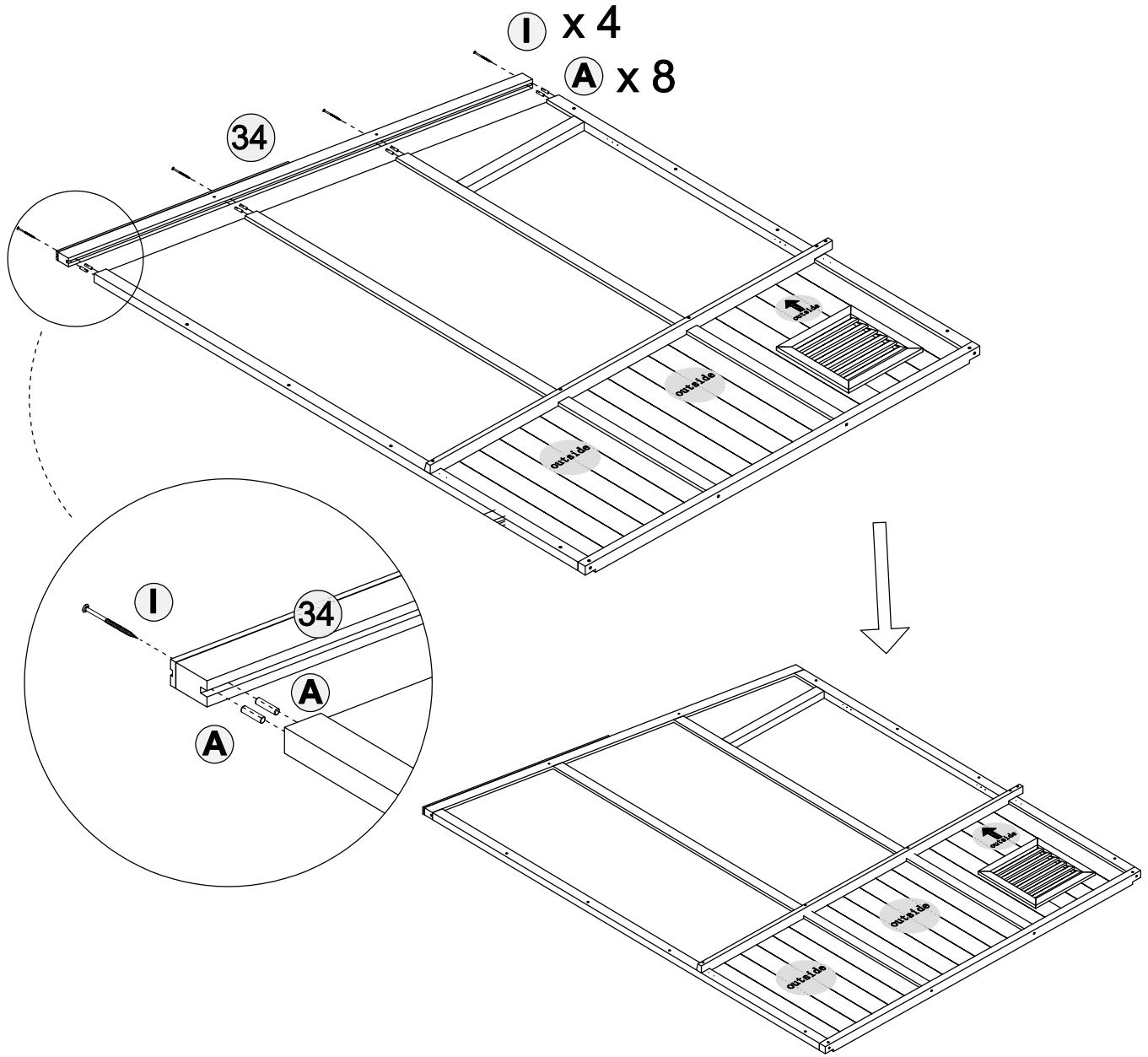

Effect after installation

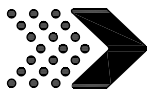

# Four sided frame assembly

Step 28

1. The diagram shows that the walls should be at a 90 degree angle to each other
2. Connect with hardware A first, then install with hardware F
3. Two people need to cooperate to do it
4. Double-check that all the door panels are facing the correct direction to avoid having to disassemble everything after the top section is installed due to an error.

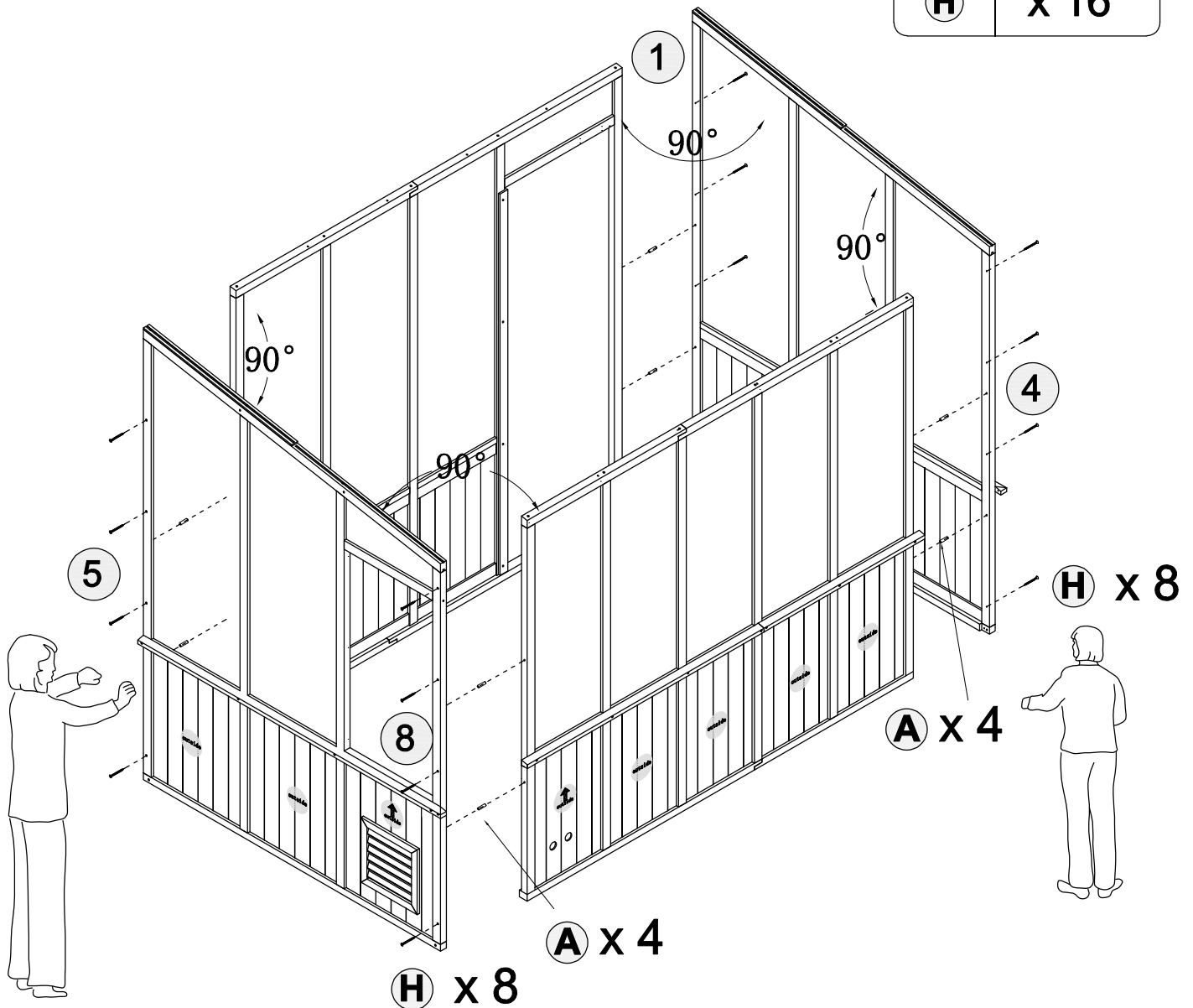
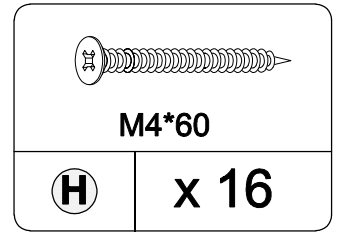
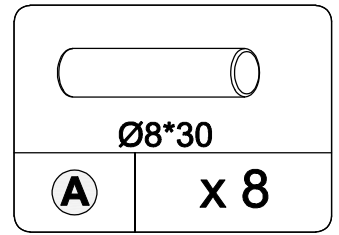

1. The diagonal of the bottom inner space is the same, with a length of 2877mm
2. After adjustment, install hardware G and I

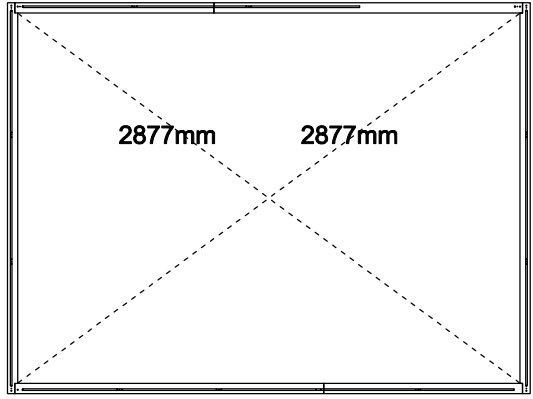

	
<b>M4*50</b>	
<b>G</b>	<b>x 3</b>

	
<b>M5*80</b>	
<b>I</b>	<b>x 4</b>

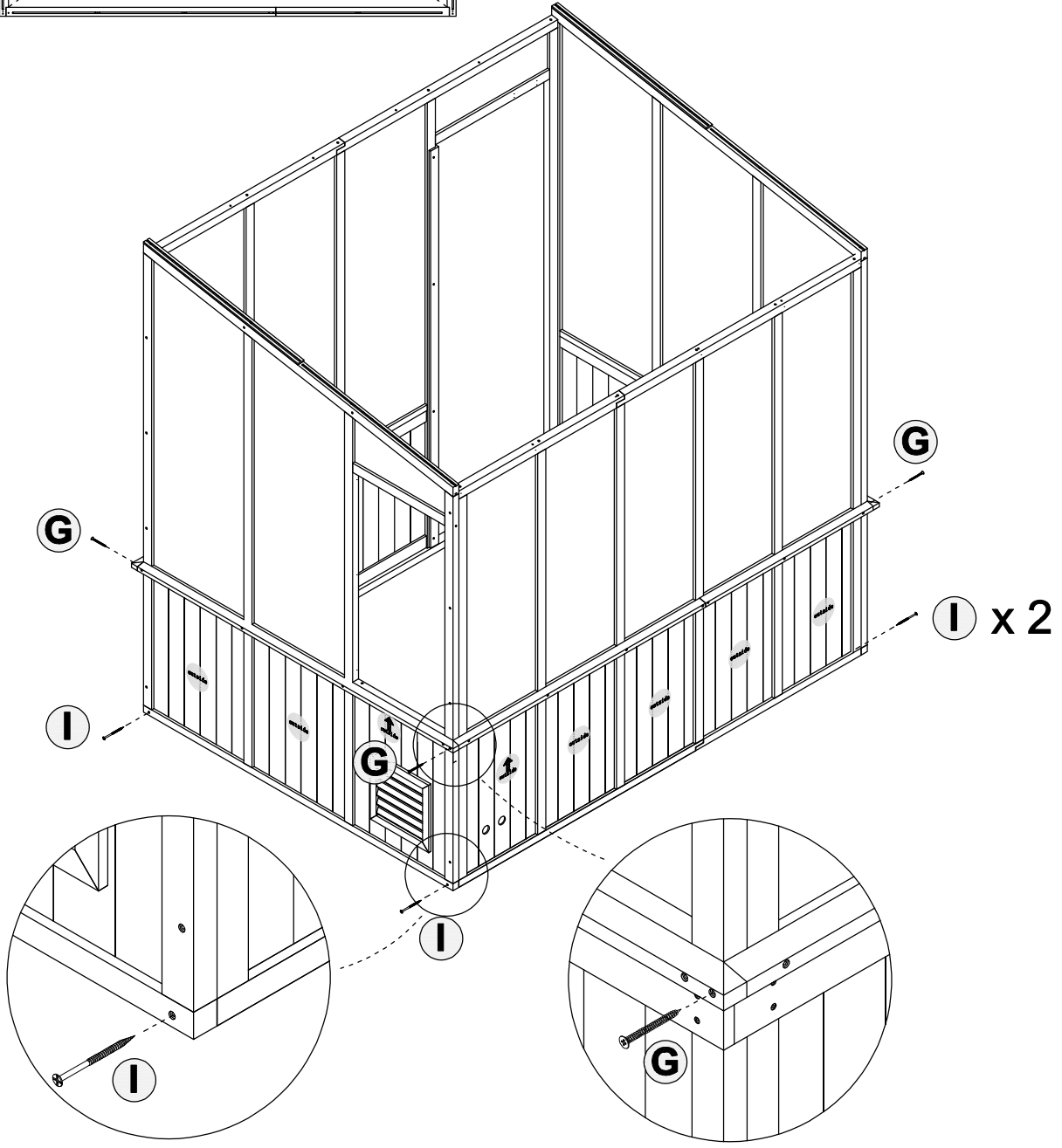

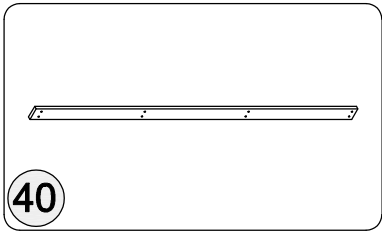

**40**

**side baffle**  
Qty: 1

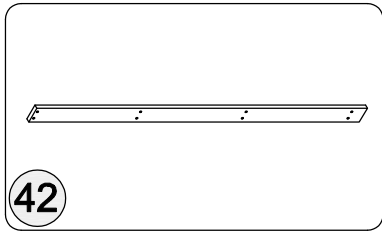

**42**

**Rear long baffle**  
Qty: 1

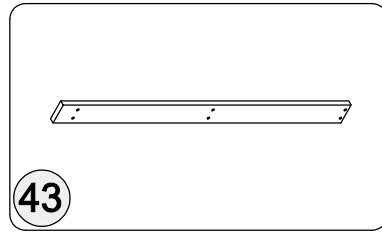

**43**

**Rear short baffle**  
Qty: 1

1. Use hardware E to pass through component and install it towards the lead hole
2. The front end of component 40 is flush with component 5, and the right end of component 42 is flush with the outer edge of component 4

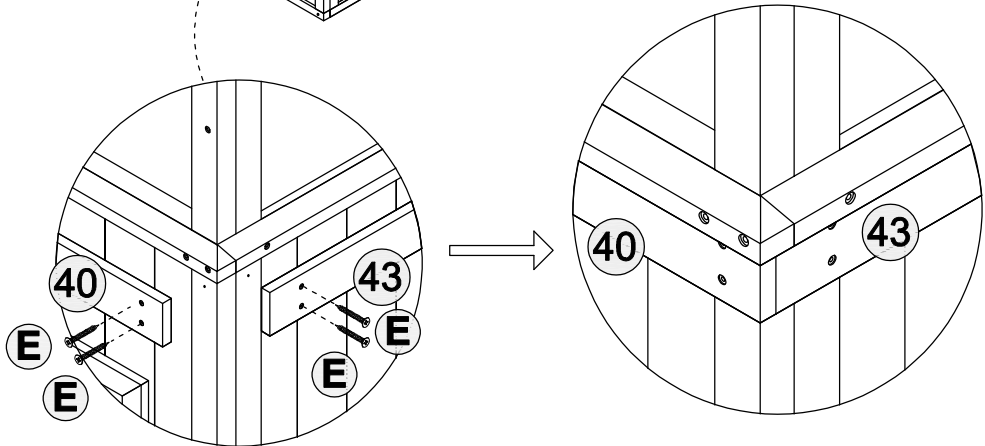
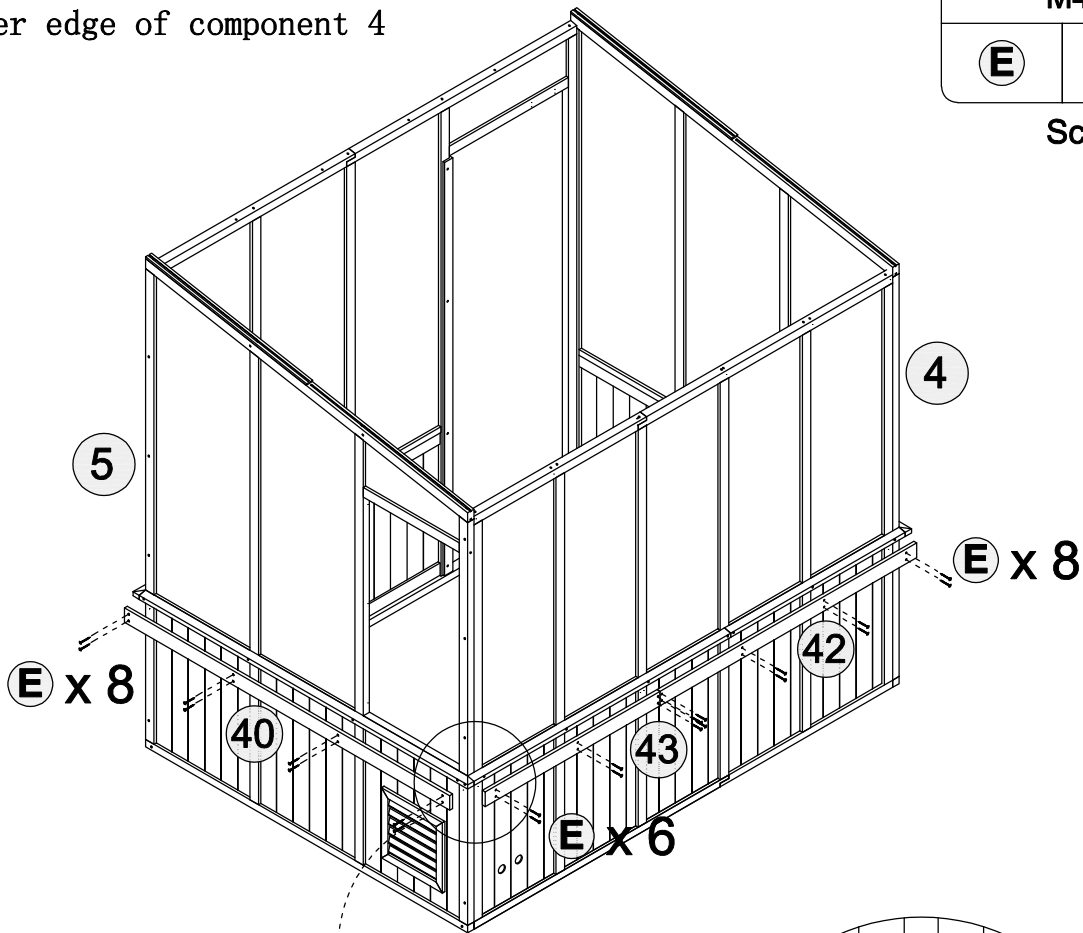
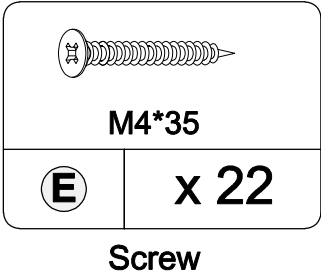

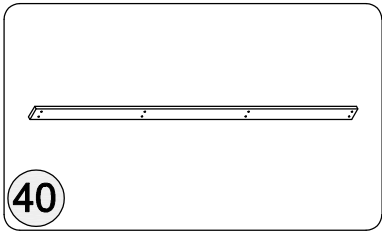

**40**  
side baffle  
Qty: 1

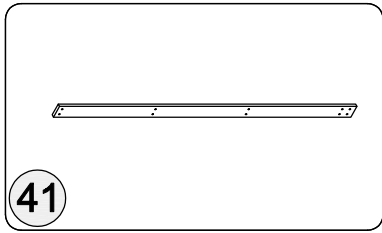

**41**  
front fender  
Qty: 1

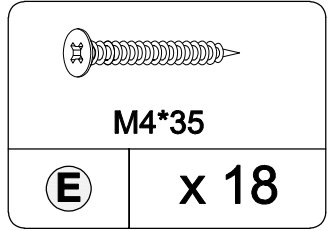

**E** | **M4\*35**  
**x 18**  
Screw

1. Use hardware E to pass through component and install it towards the lead hole

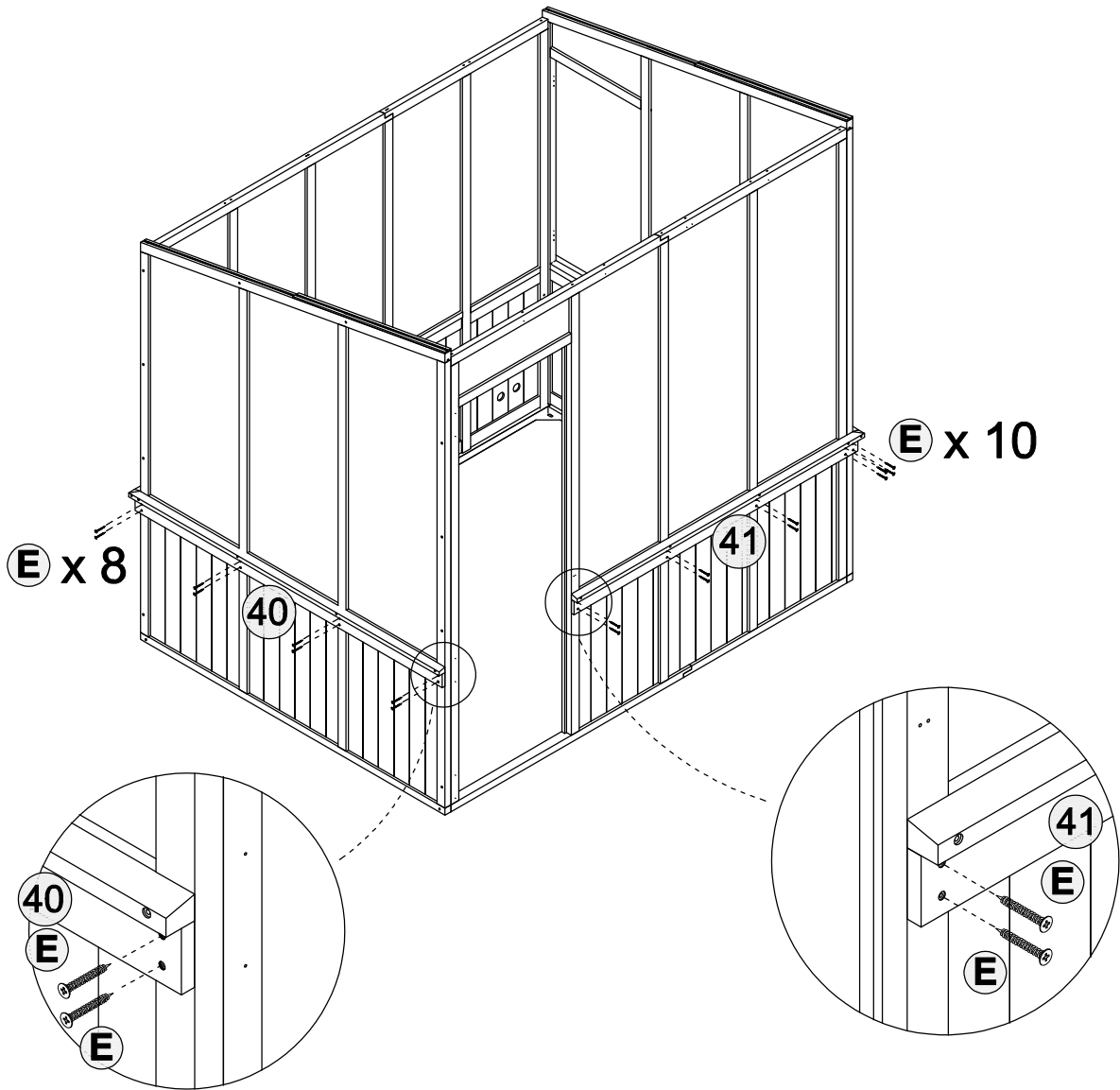

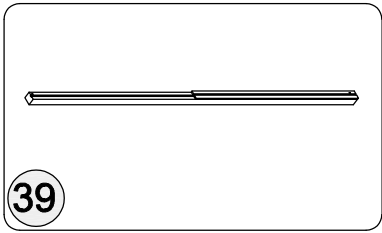

middle beam  
Qty: 4

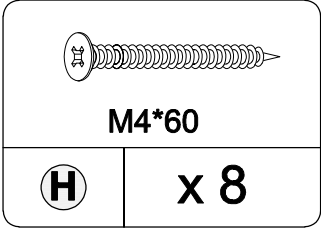
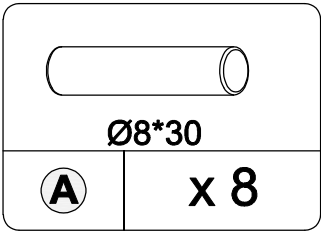

1. Connect with hardware A first, then install with hardware H
2. It needs to be installed one by one in sequence

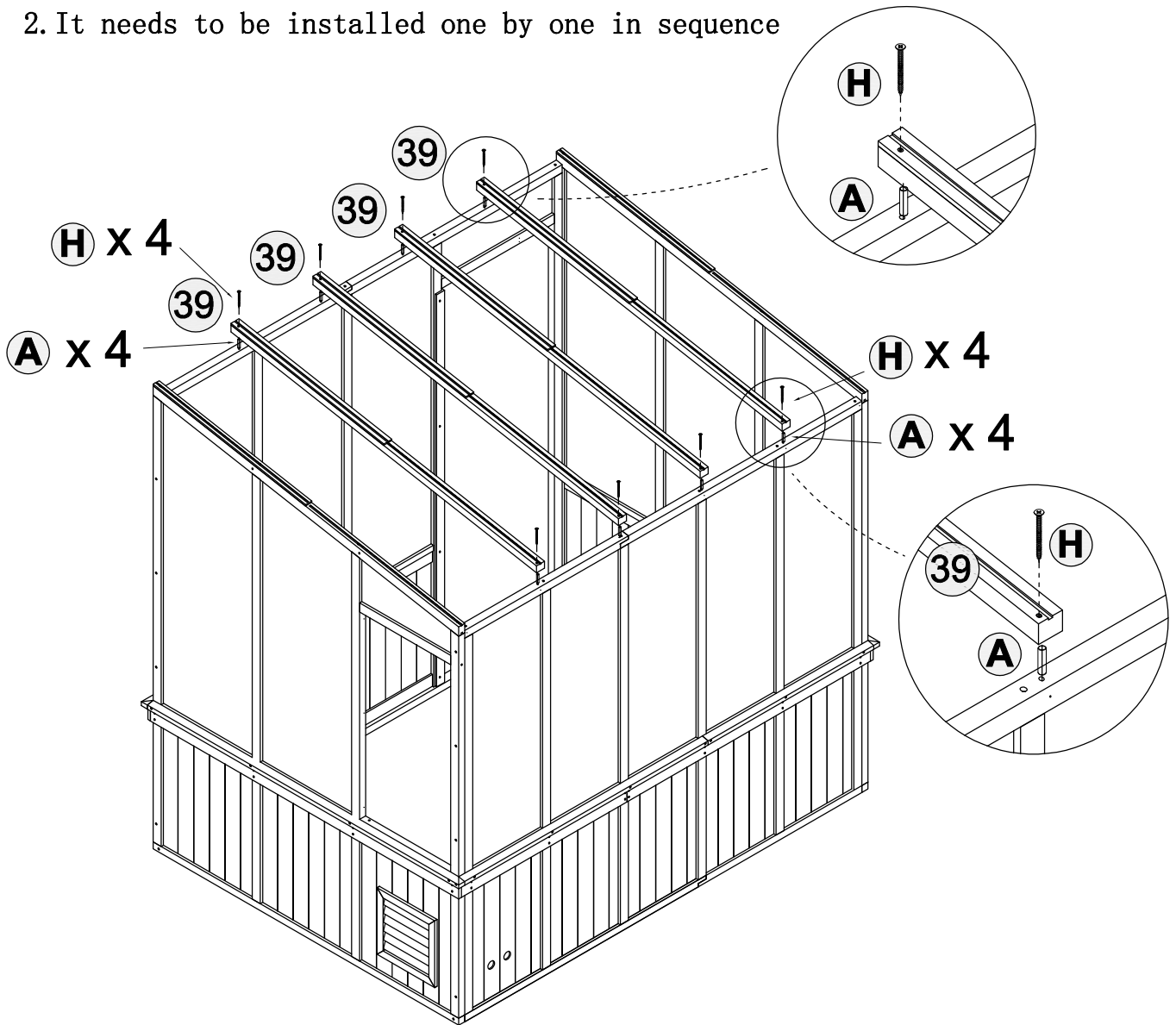

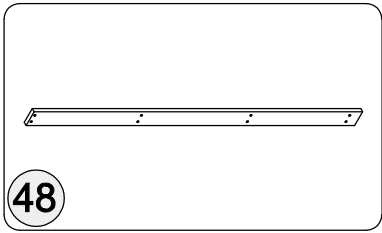

**Top rear long baffle**  
Qty: 1

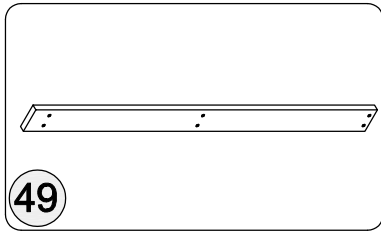

**Top rear short baffle**  
Qty: 1

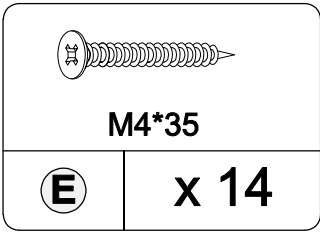

1. Use hardware E to pass through component 48 and install it towards the lead hole

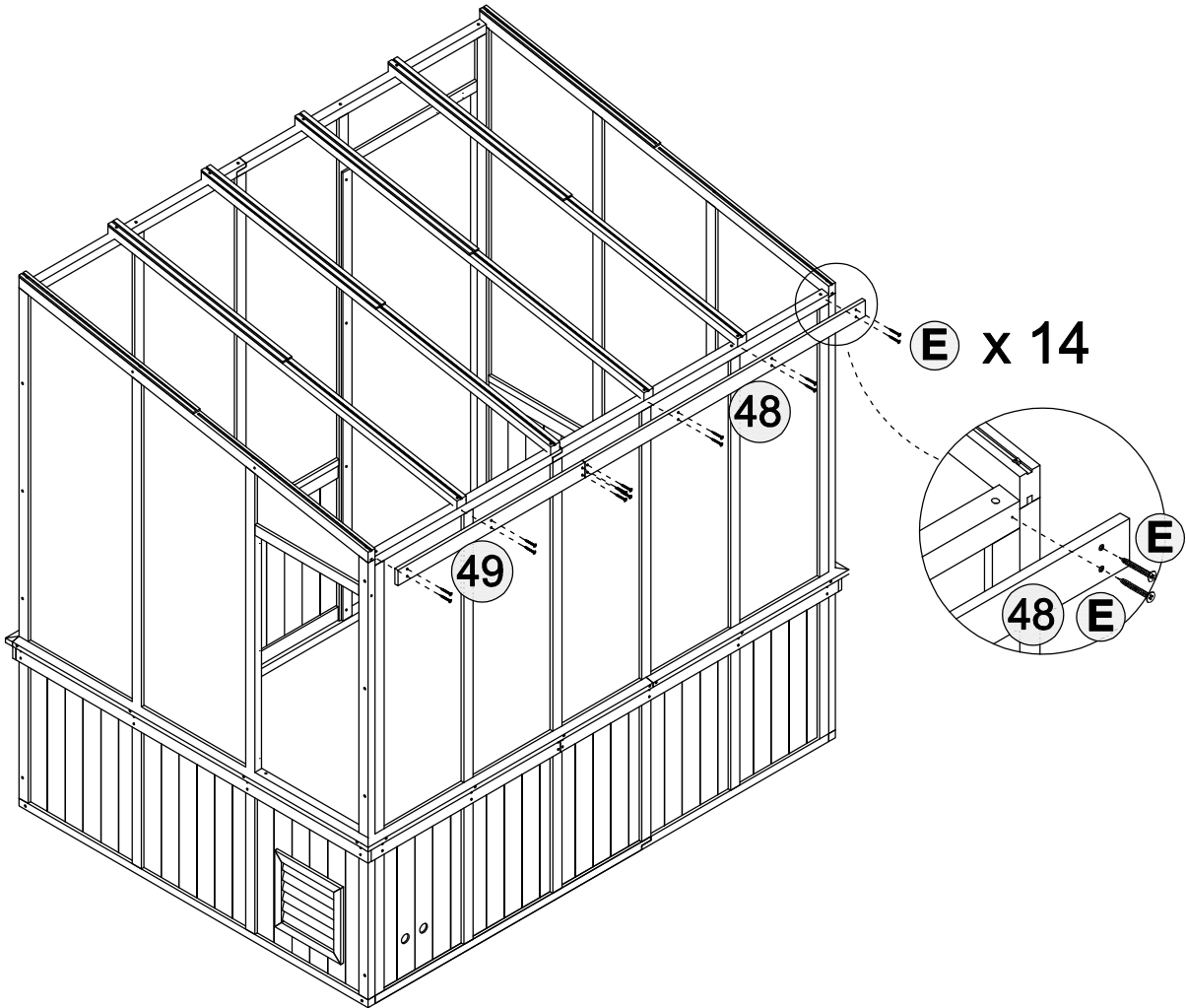

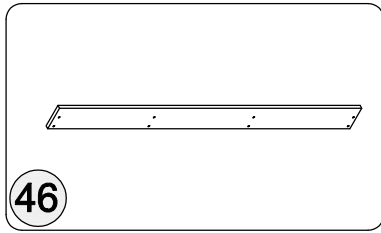
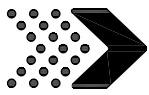

46

Top front long baffle

Qty: 1

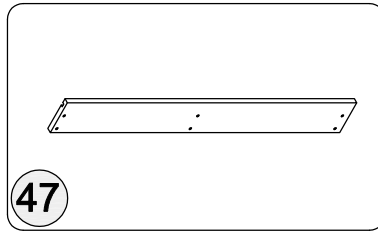

47

Top front short baffle

Qty: 1

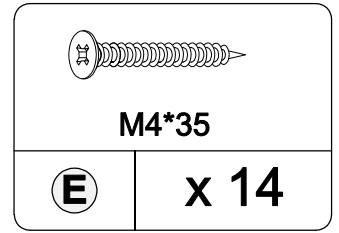

M4\*35

E

X 14

1. Components 46 and 47 have slots facing upwards from the back, and after installation, the bottom of the slots should be level with the top of the inclined beam
2. Use hardware E to pass through component 47 and install it towards the lead hole

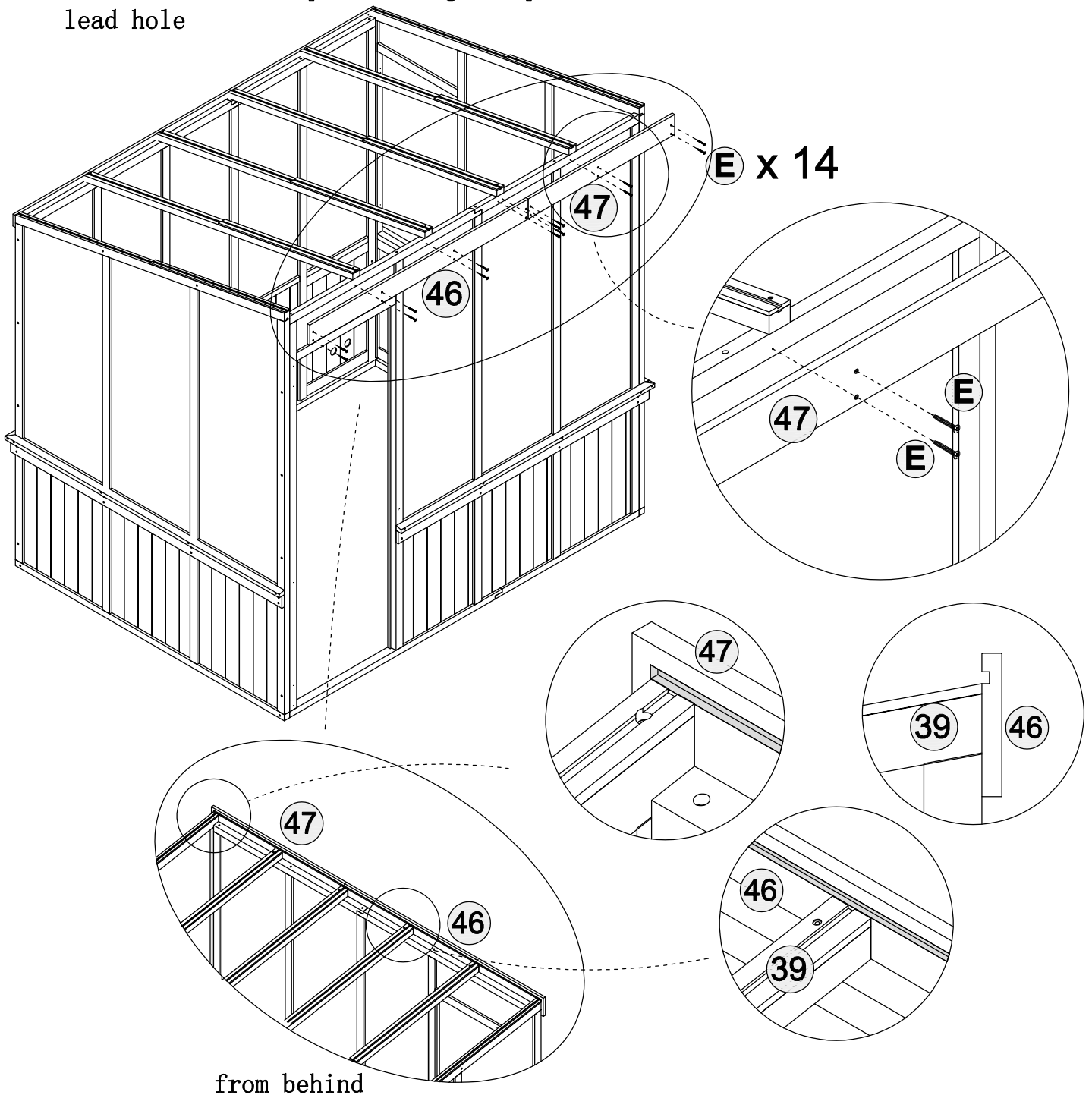

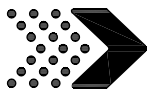

**44**  
Top left baffle  
Qty: 1



**45**  
Top right baffle  
Qty: 1

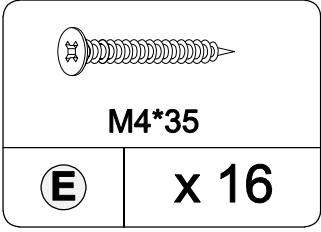
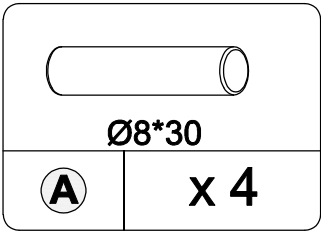

1. Connect with hardware A first, then install with hardware E

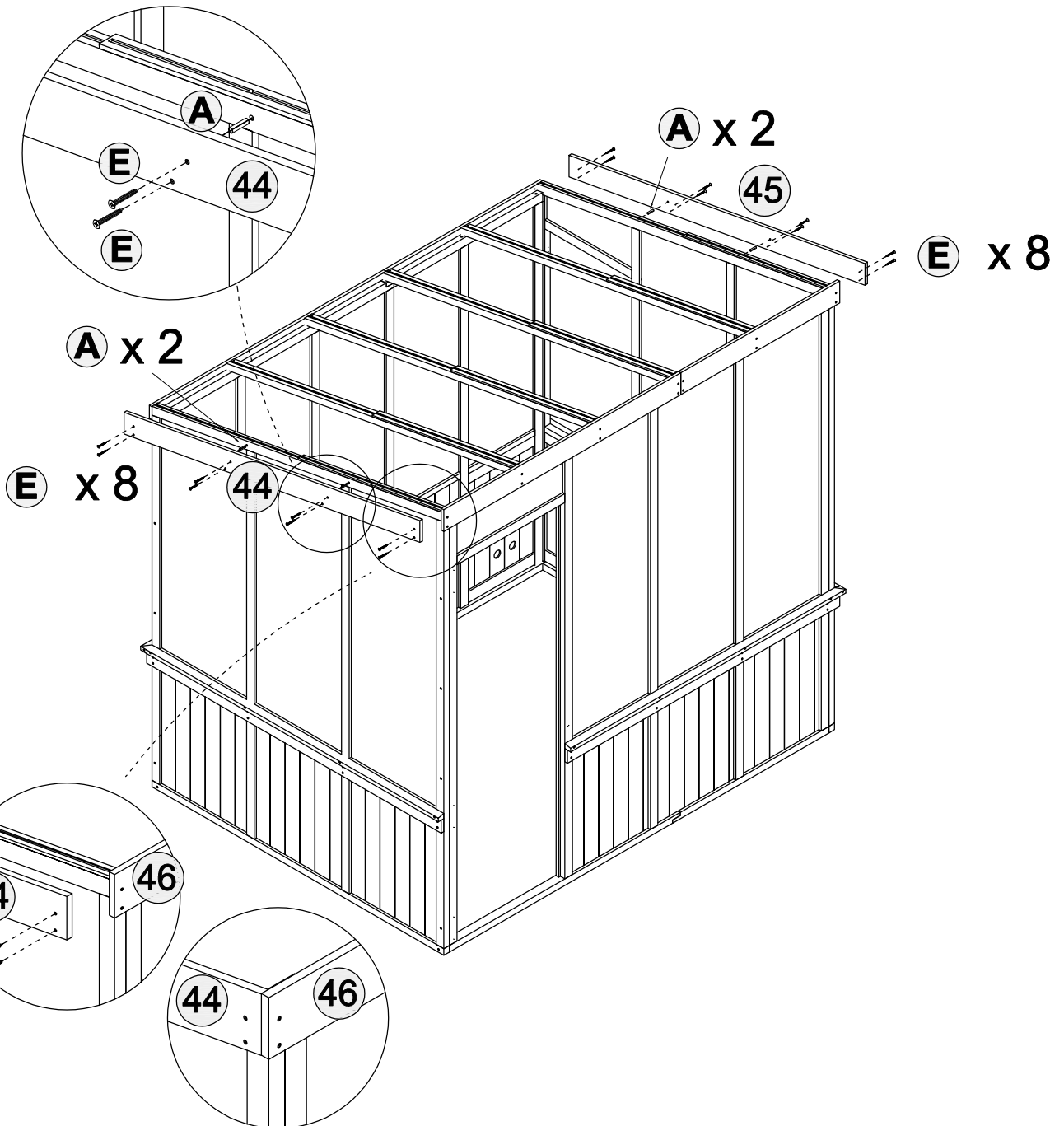

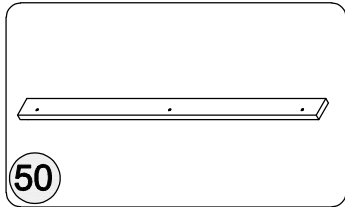
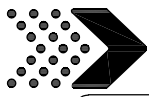

50

Top cover plate  
Qty: 1

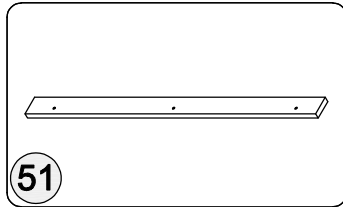

51

Top cover plate  
Qty: 1

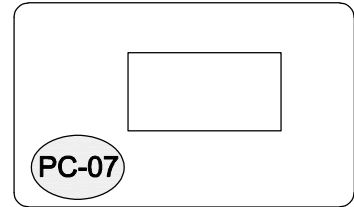

PC-07

Top Sunshine Board  
Qty: 1

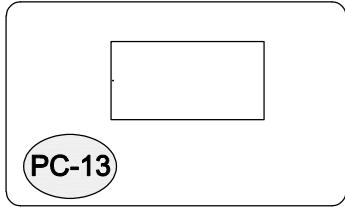

PC-13

Top rear sunlight panel  
Qty: 1

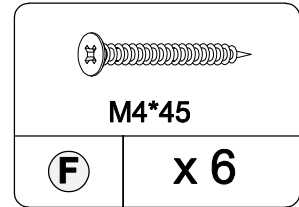

M4\*45

F

x 6

1. The component on the outer side of PC-13 that is flush with the edge
2. Place the front end of component PC-07 onto the front component and cover it with component PC-13
3. The components on the top and right sides of component 50 that are flush with each other
4. Before installing each PC component, the film should be peeled off first

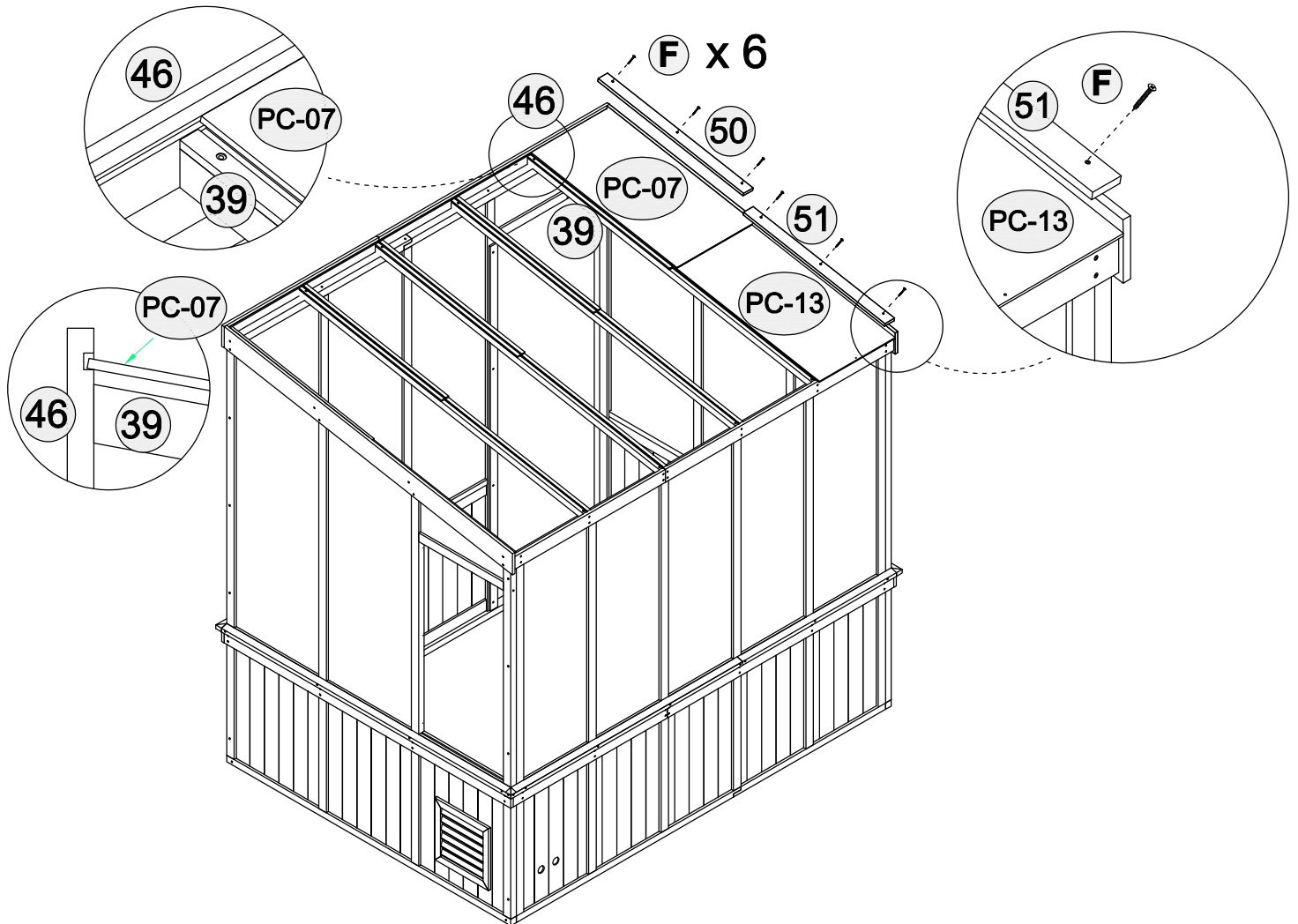

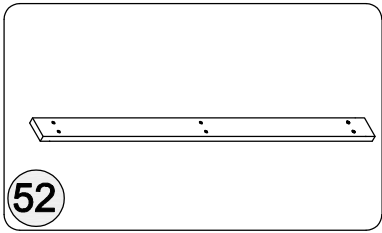

**52**

**Top middle cover plate**  
Qty: 1

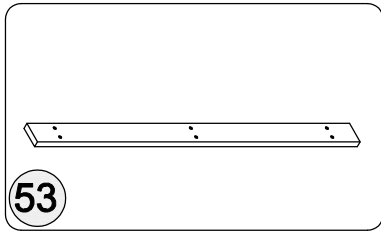

**53**

**Top middle cover plate**  
Qty: 1

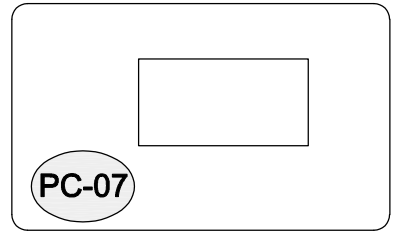

**PC-07**

**Top Sunshine Board**  
Qty: 1

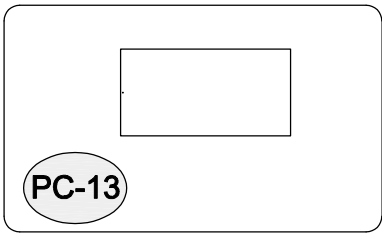

**PC-13**

**Top rear sunlight panel**  
Qty: 1

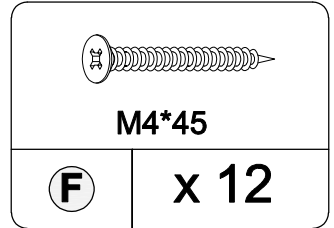

1. Place the components PC-07 and PC-13 according to the original method, with a gap of about 3MM on the edges
2. Components 52 and 53 are pressed in the middle of the PC component
3. Before installing each PC component, the film should be peeled off first

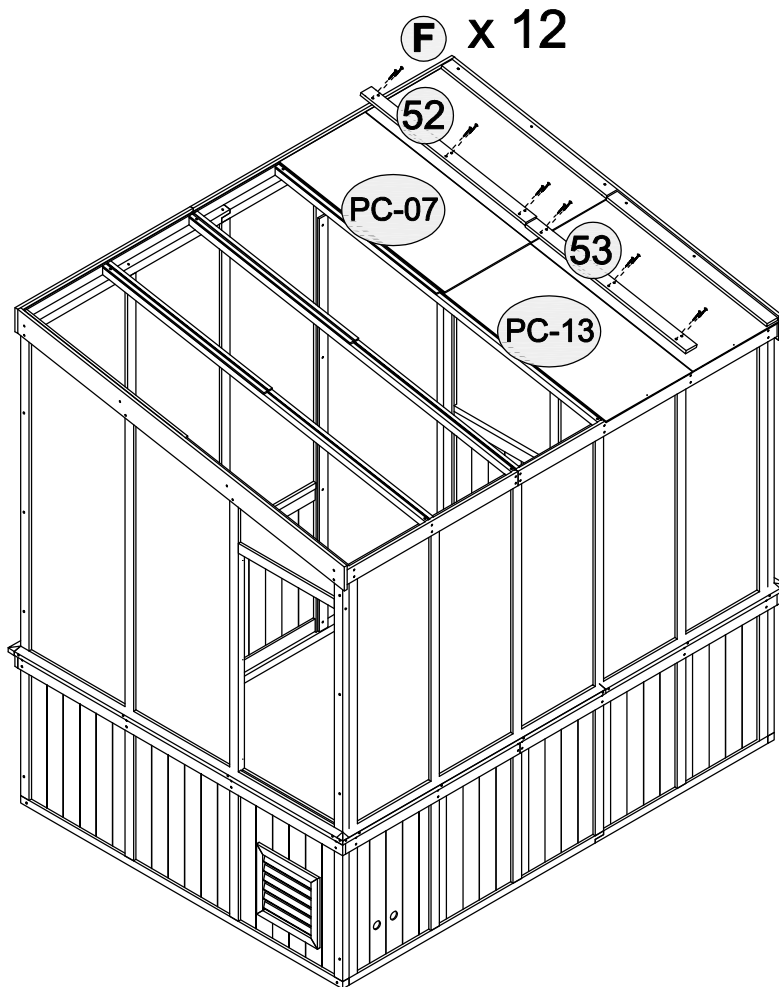

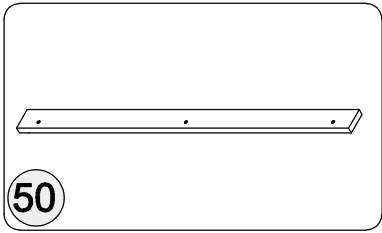
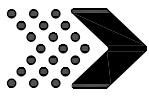

50

Top cover plate  
Qty: 1

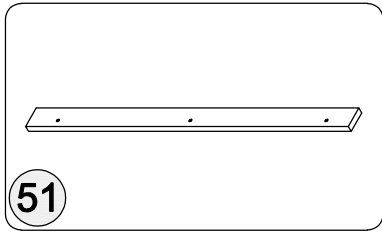

51

Top cover plate  
Qty: 1

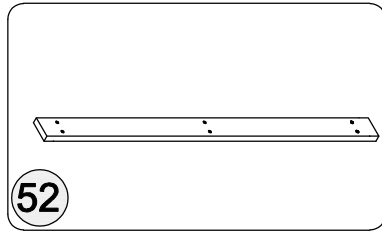

52

Top middle cover plate  
Qty: 3

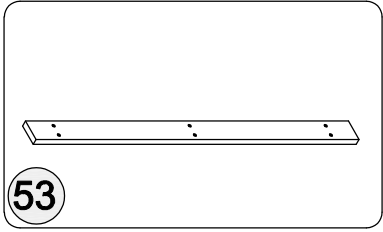

53

Top middle cover plate  
Qty: 3

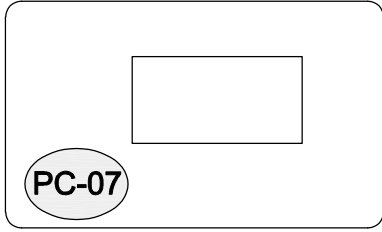

PC-07

Top Sunshine Board  
Qty: 3

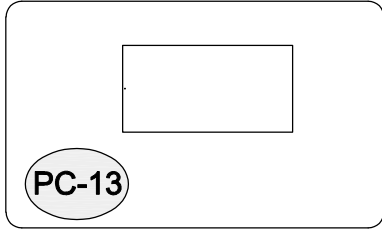

PC-13

Top rear sunlight panel  
Qty: 3

1. Install the components in sequence according to the original method
2. Before installing each PC component, the film should be peeled off first

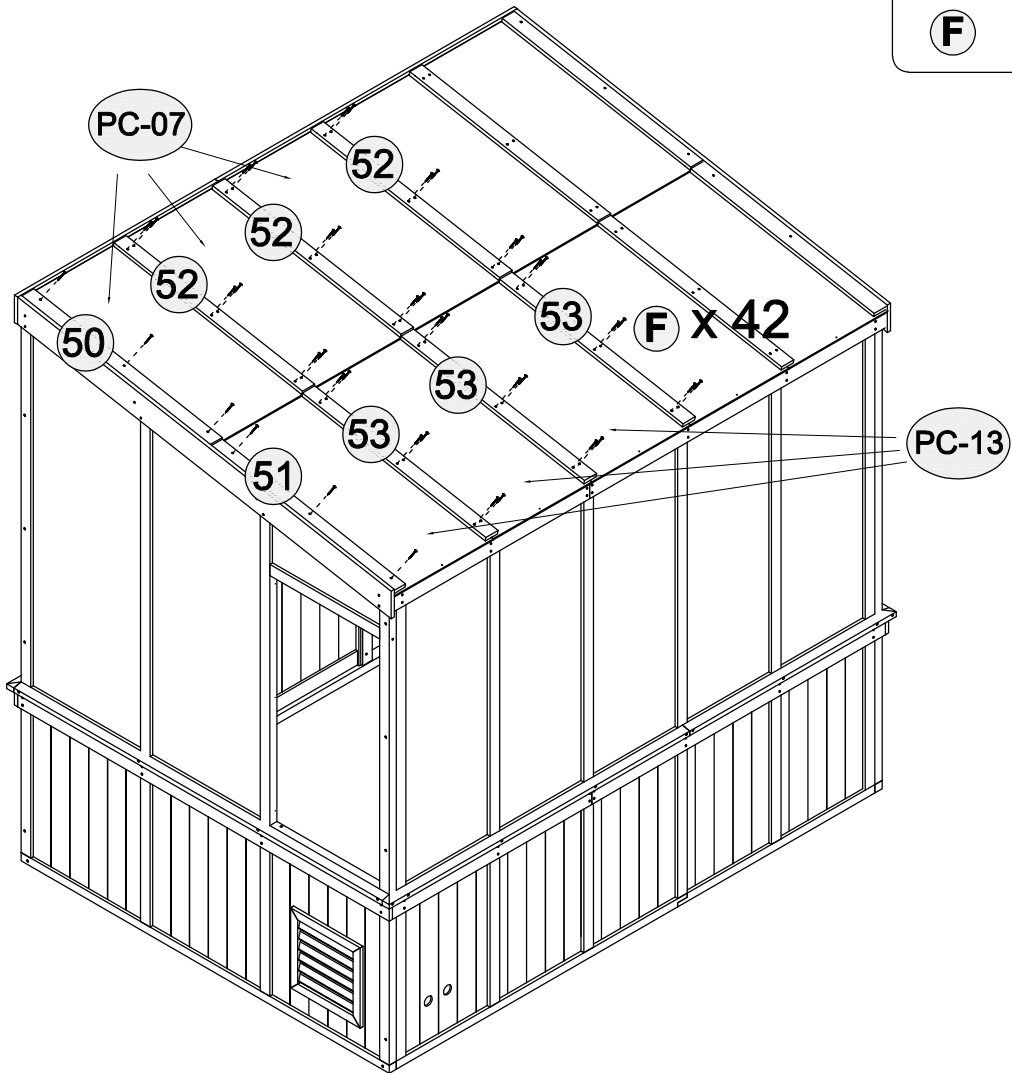
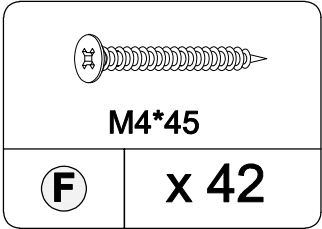

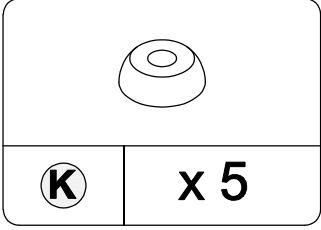
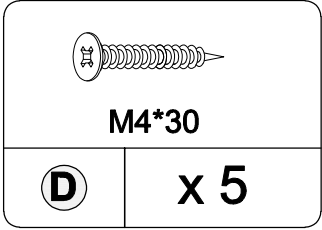

1. Thread hardware D through hardware K and install it into the lead hole of component PC-13

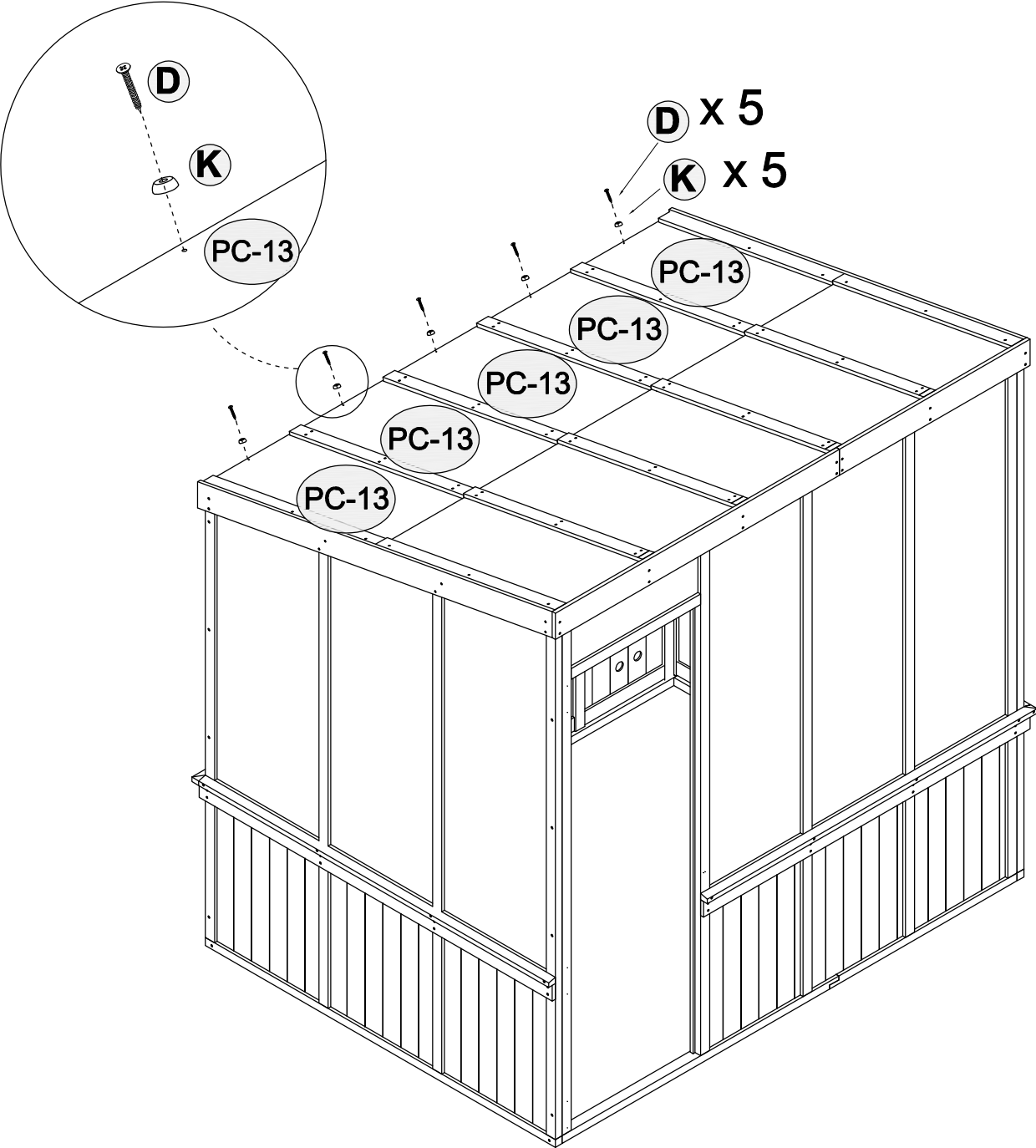

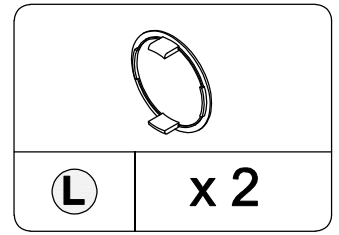
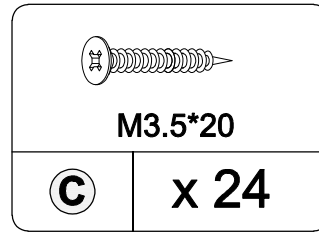
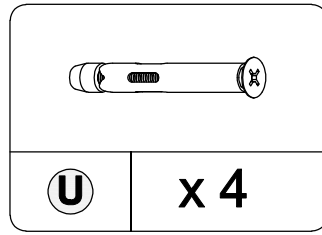
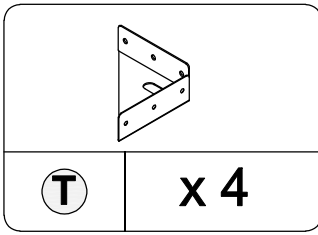
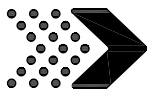

1. The four corners of the room have the same corner code, and the hardware U is installed underground through the hardware T
2. Cover with hardware L

The four corners are fitted with such corner codes

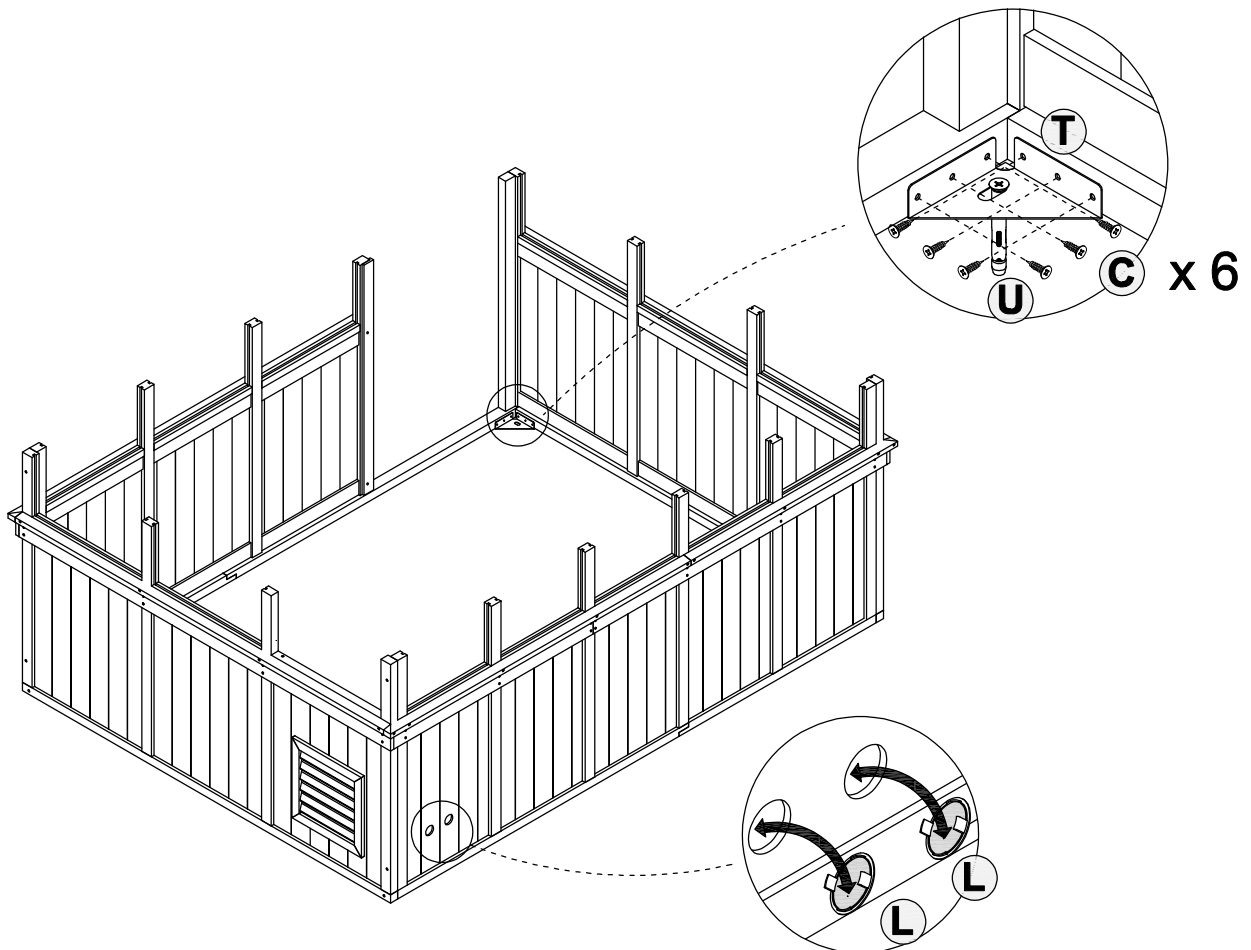

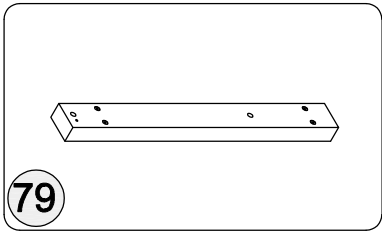

**79**  
vertical bar  
Qty: 5

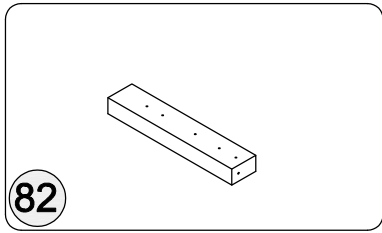

**82**  
Triangular horizontal bar  
Qty: 5

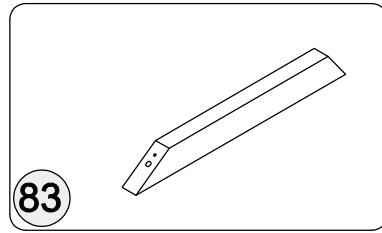

**83**  
Triangular diagonal bar  
Qty: 5

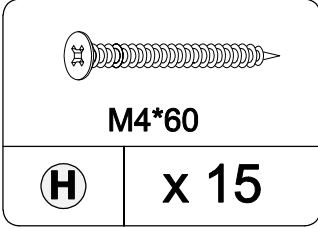
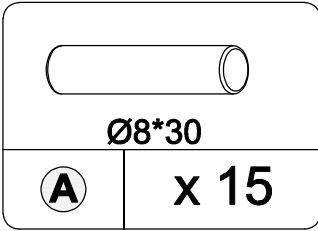

1. Connect with hardware A first, then install with hardware H
2. Install a total of 5

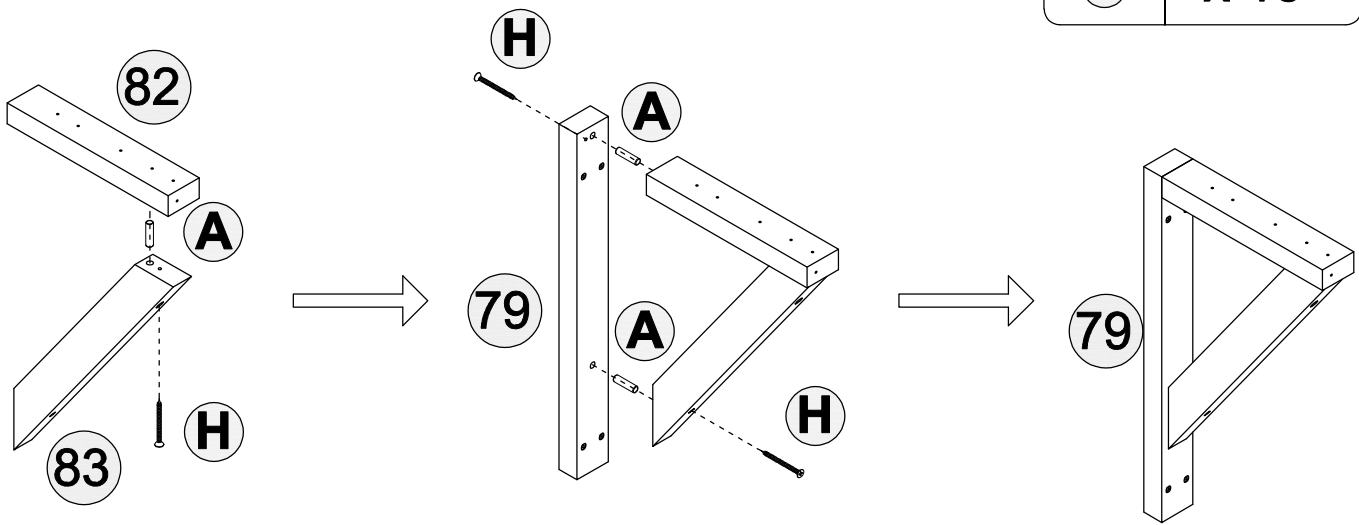

Install a total of 5

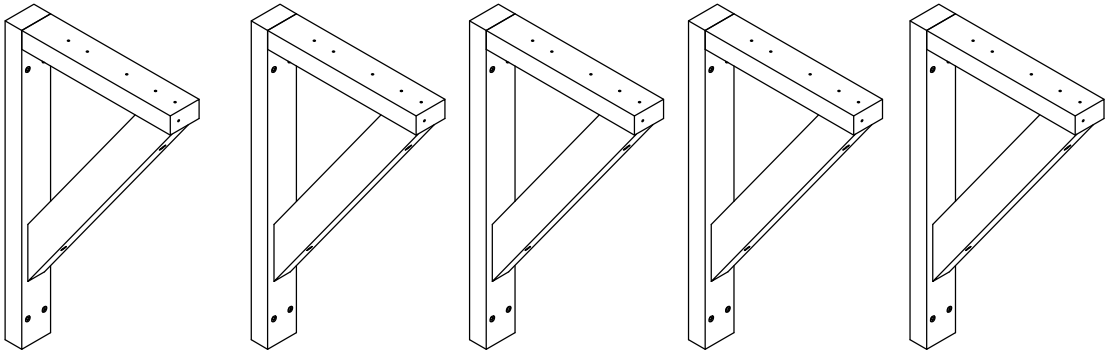

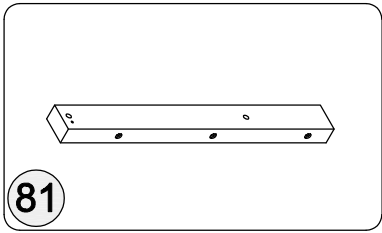

**81**  
Right vertical bar  
Qty: 1

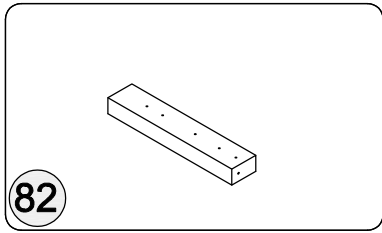

**82**  
Triangular horizontal bar  
Qty: 1

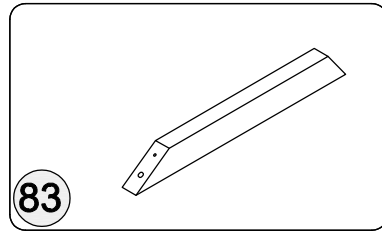

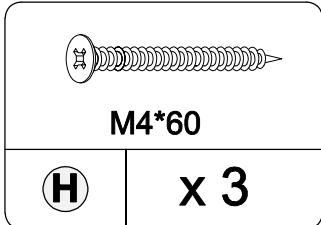
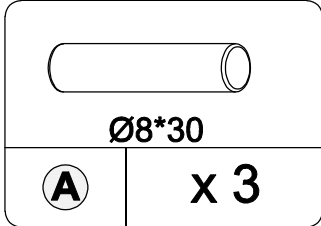

**83**  
Triangular diagonal bar  
Qty: 1

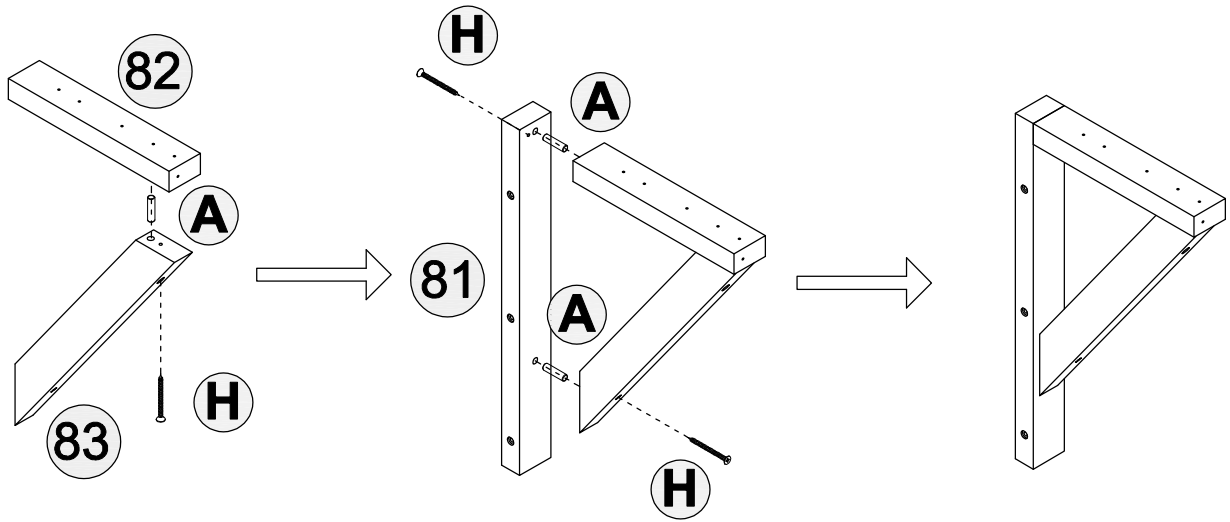

1. Connect with hardware A first, then install with hardware H



	
M4*60	
<b>H</b>	x 3

	
Ø8*30	
<b>A</b>	x 2

1. Connect with hardware A first, then install with hardware H

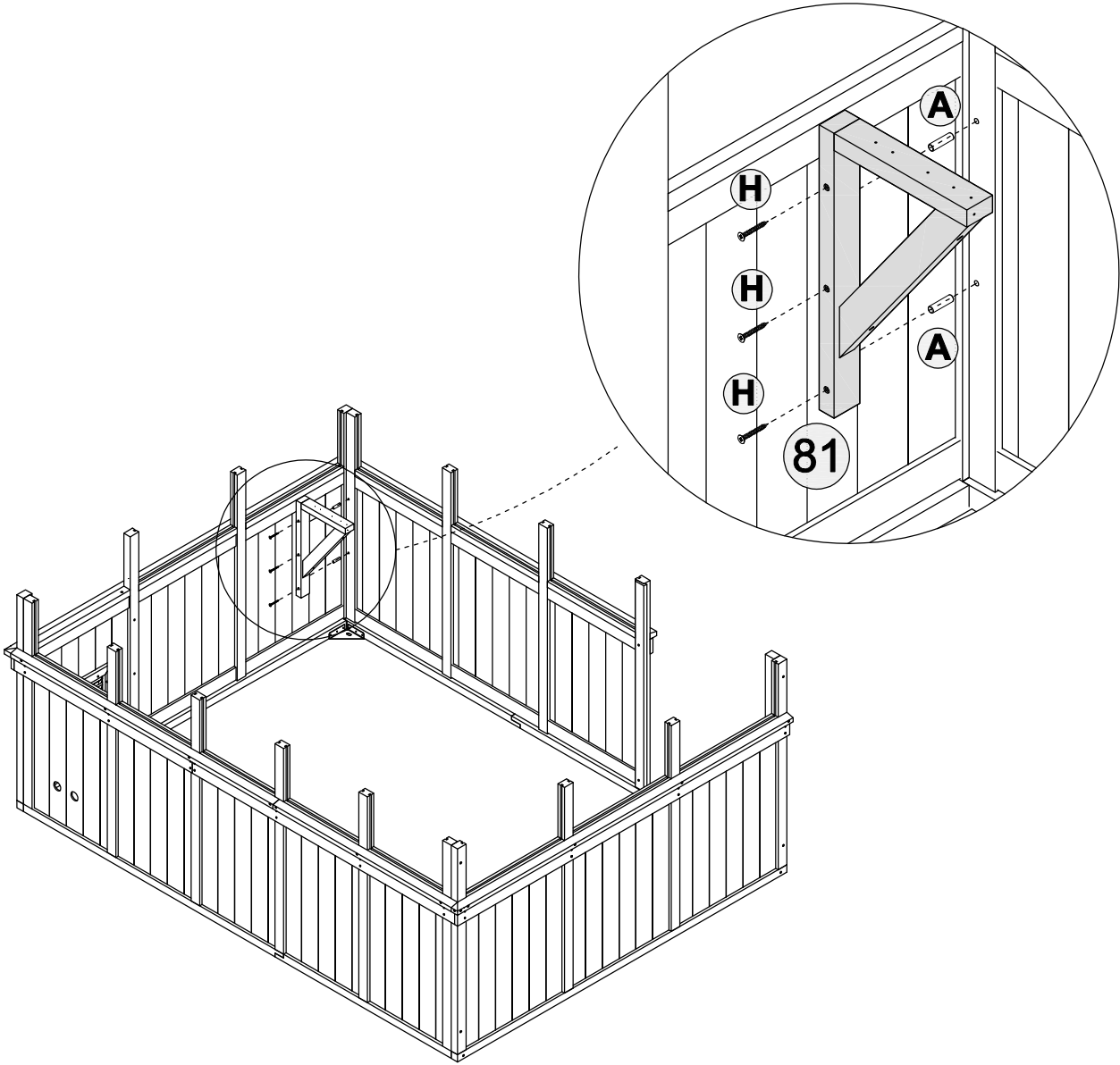

1. Connect with hardware A first, then install with hardware G

	
Ø8*30	
<b>A</b>	<b>x 8</b>

	
M4*50	
<b>G</b>	<b>x 16</b>

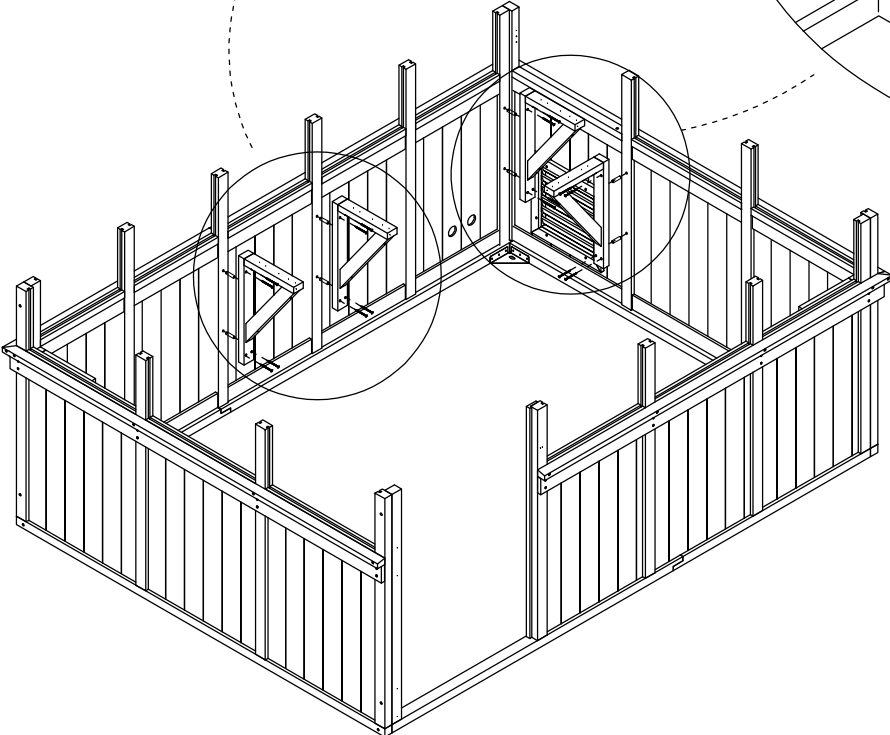
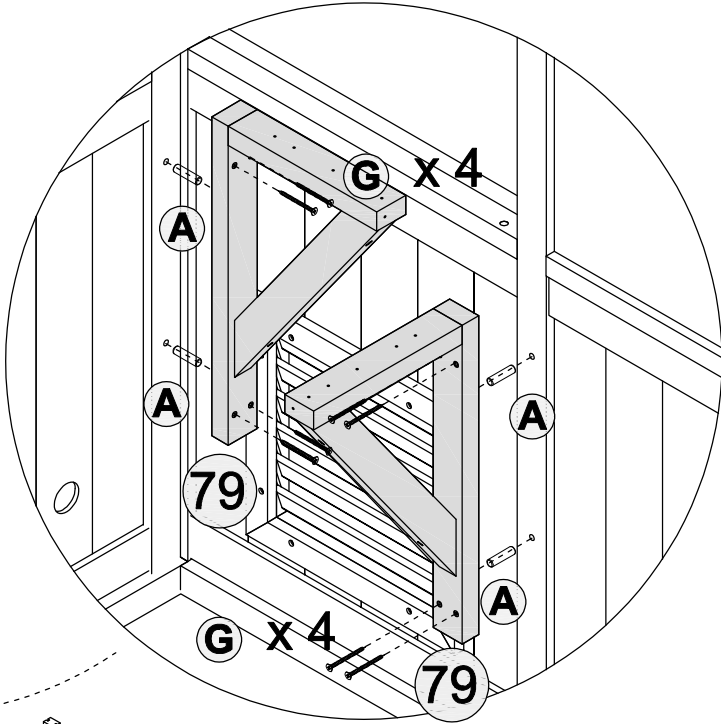
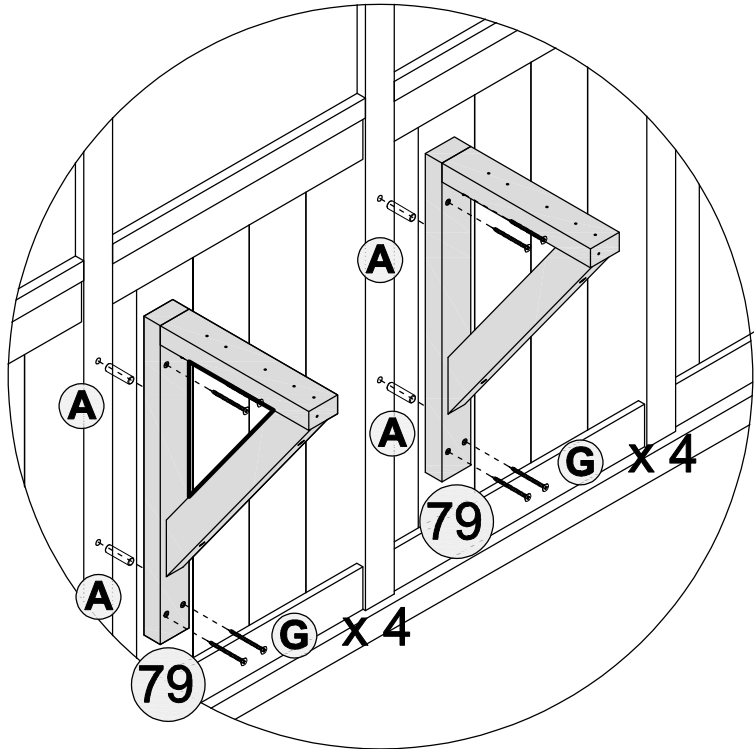

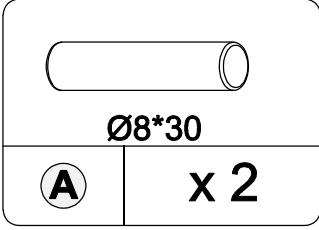
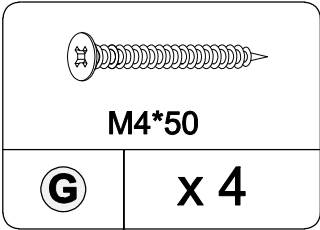

1. Connect with hardware A first, then install with hardware G

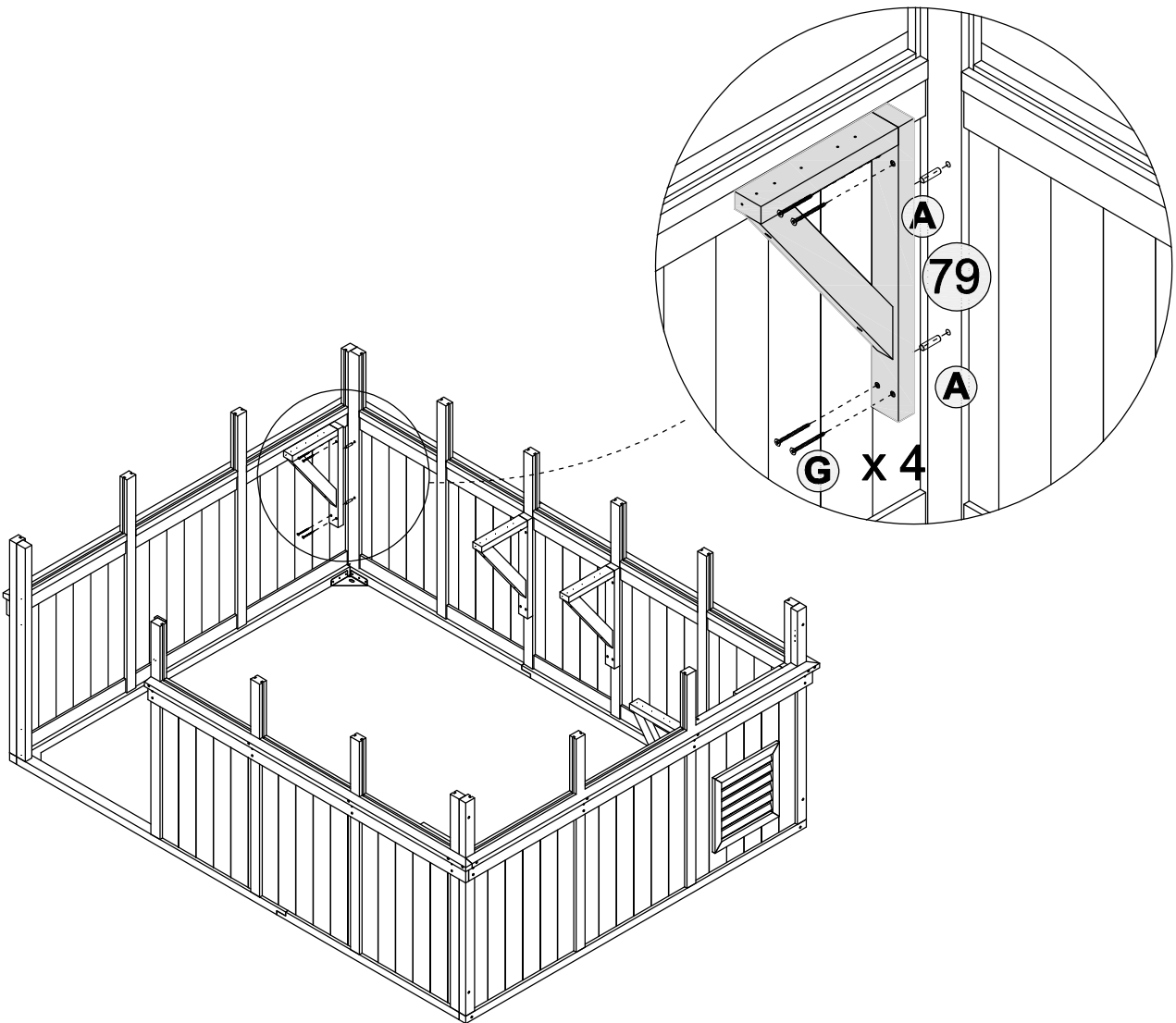

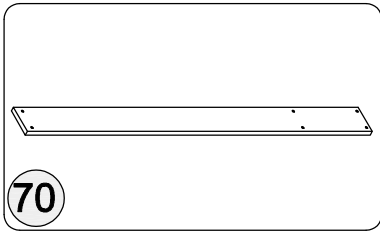
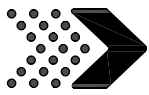

**70**  
Rear left layer board  
Qty: 2

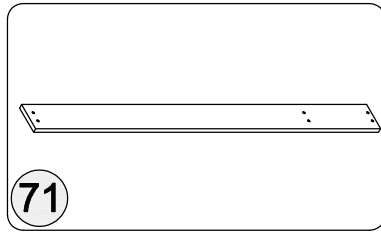

**71**  
Rear left layer board  
Qty: 1

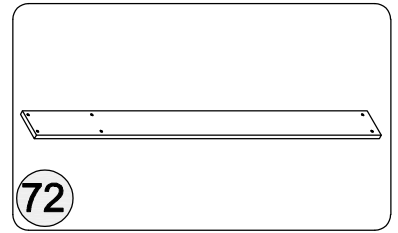

**72**  
Rear right layer board  
Qty: 2

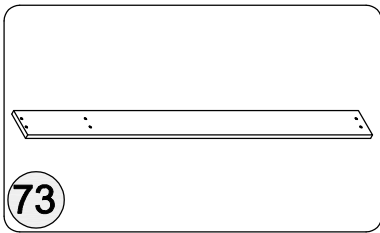

**73**  
Rear right layer board  
Qty: 1

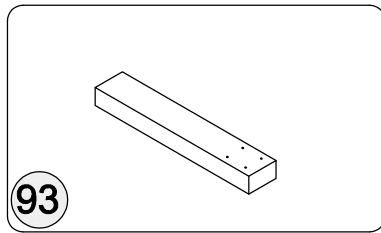

**93**  
connecting strip  
Qty: 1

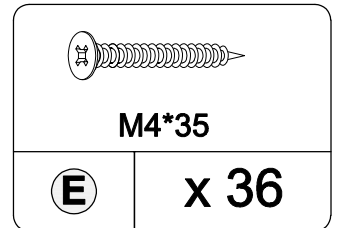

1. Use hardware E to pass through component and install it towards the lead hole

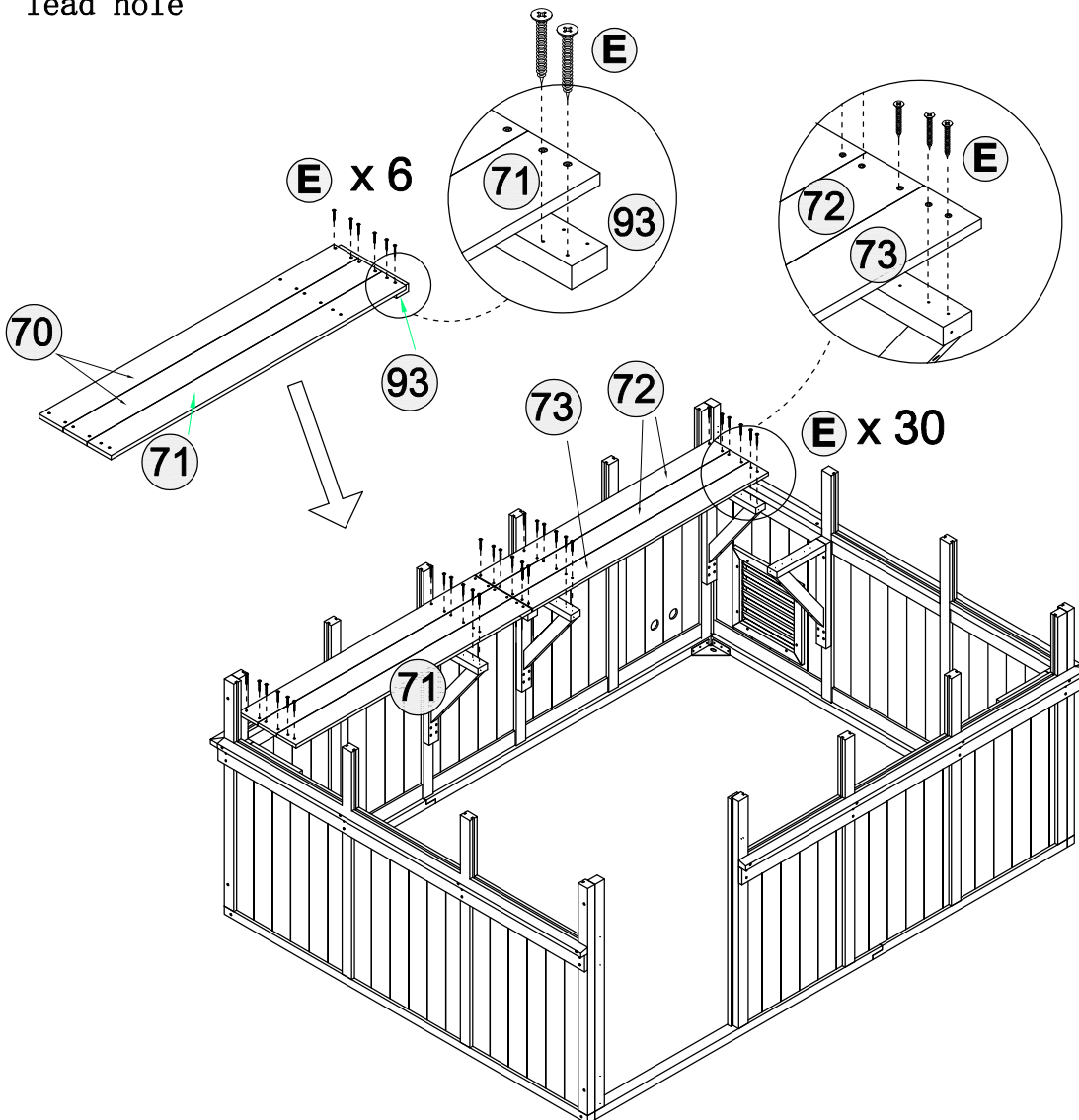

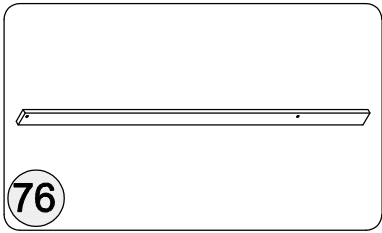

Front gear strip  
Qty: 1

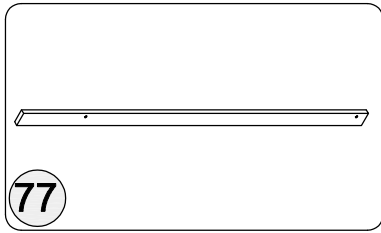

Front gear strip  
Qty: 1

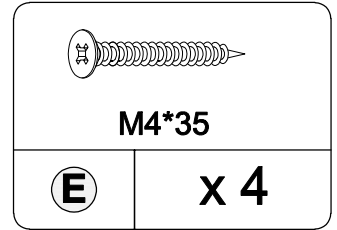

1. Use hardware E to pass through component 76,77, and install it towards the lead hole

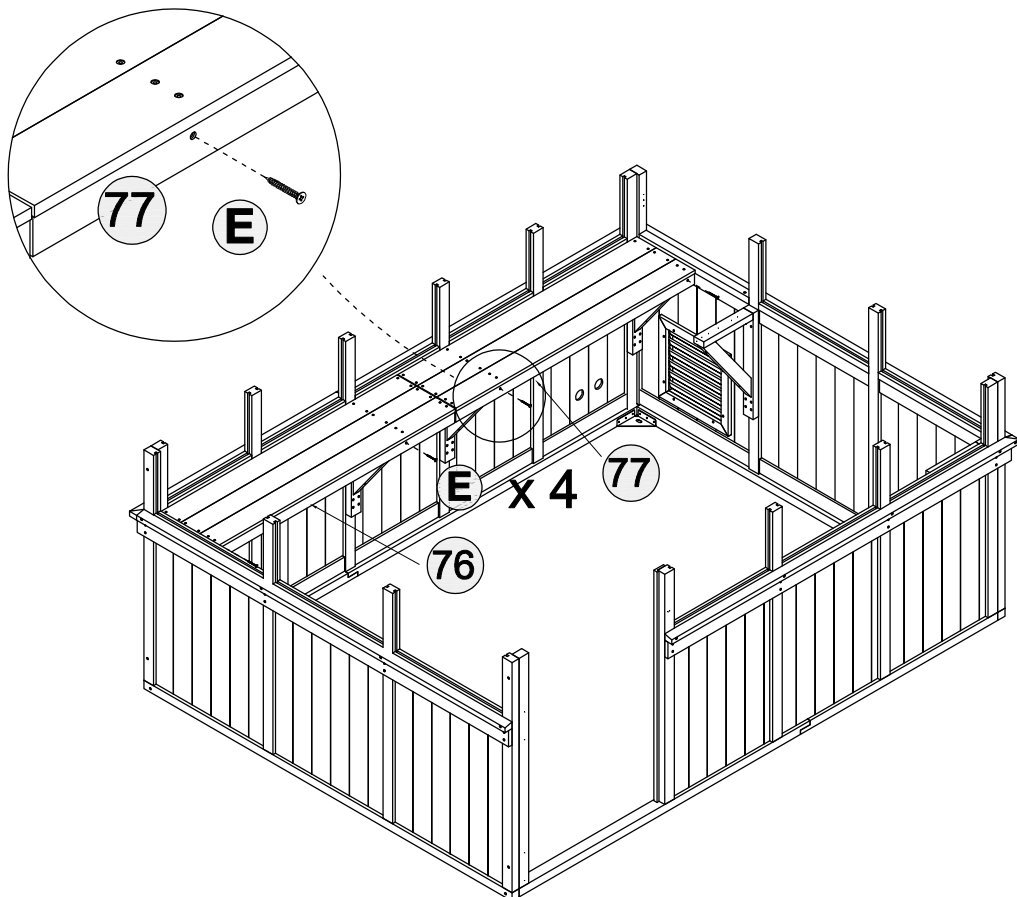

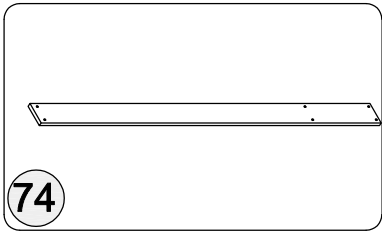

**74**  
Right middle Flat noodles  
Qty: 1

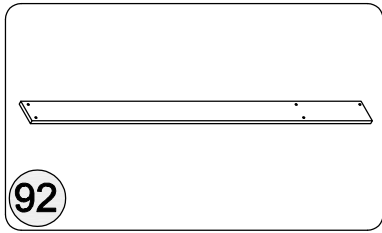

**92**  
Right rear Flat noodles  
Qty: 1

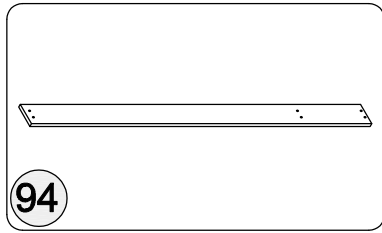

**94**  
Front right Flat noodles  
Qty: 1

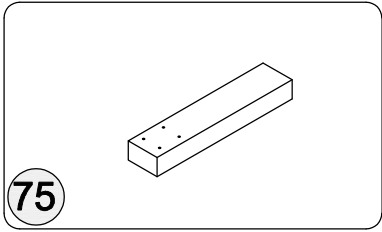

**75**  
connecting strip  
Qty: 1

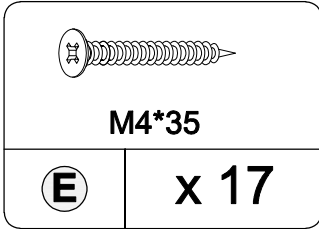

1. Use hardware E to pass through component and install it towards the lead hole

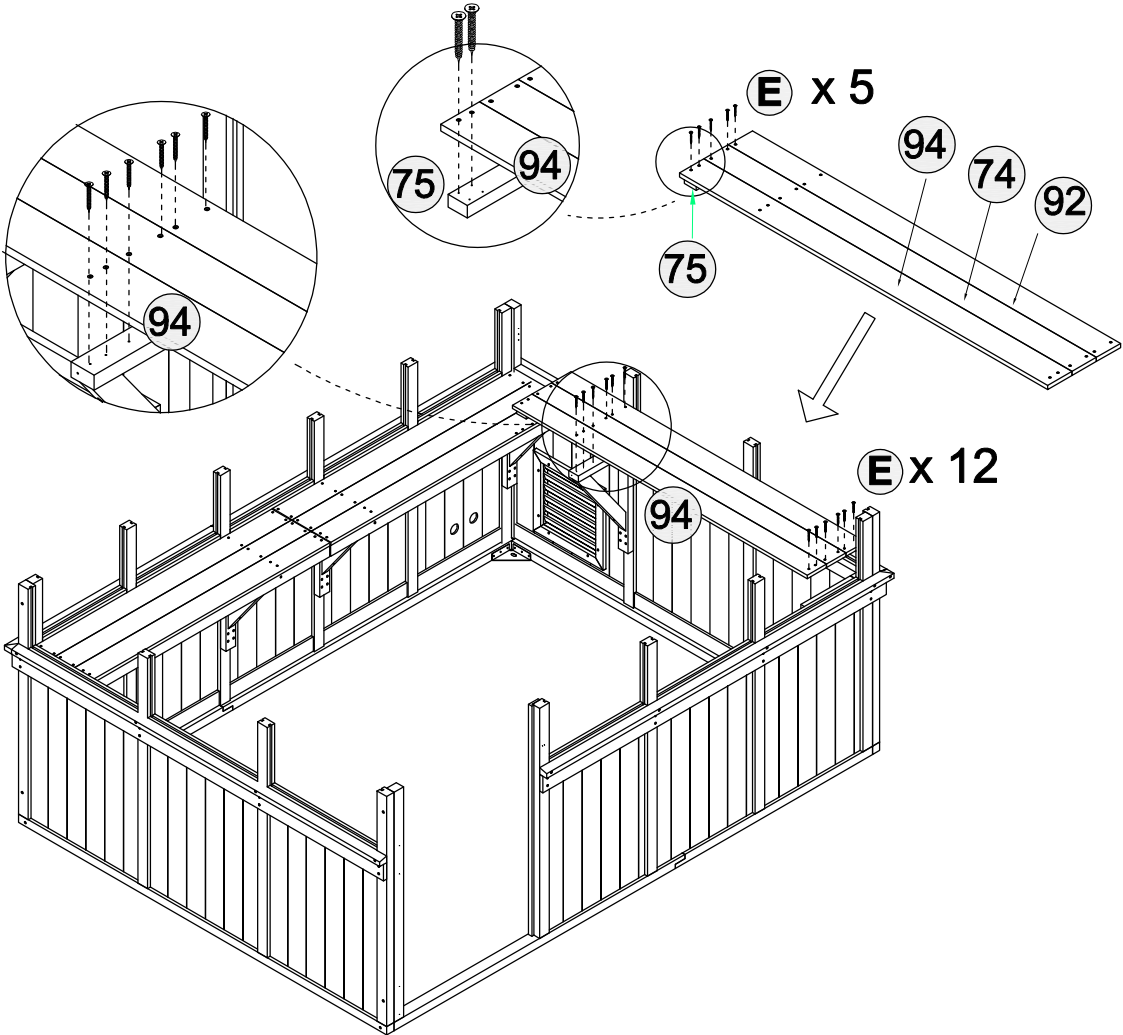

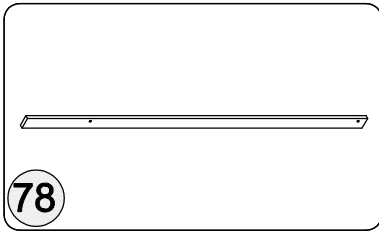
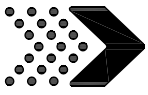

Right front gear strip  
Qty: 1

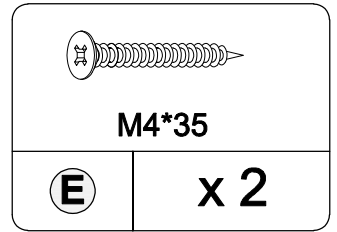

1. Use hardware E to pass through component 78 and install it towards the lead hole

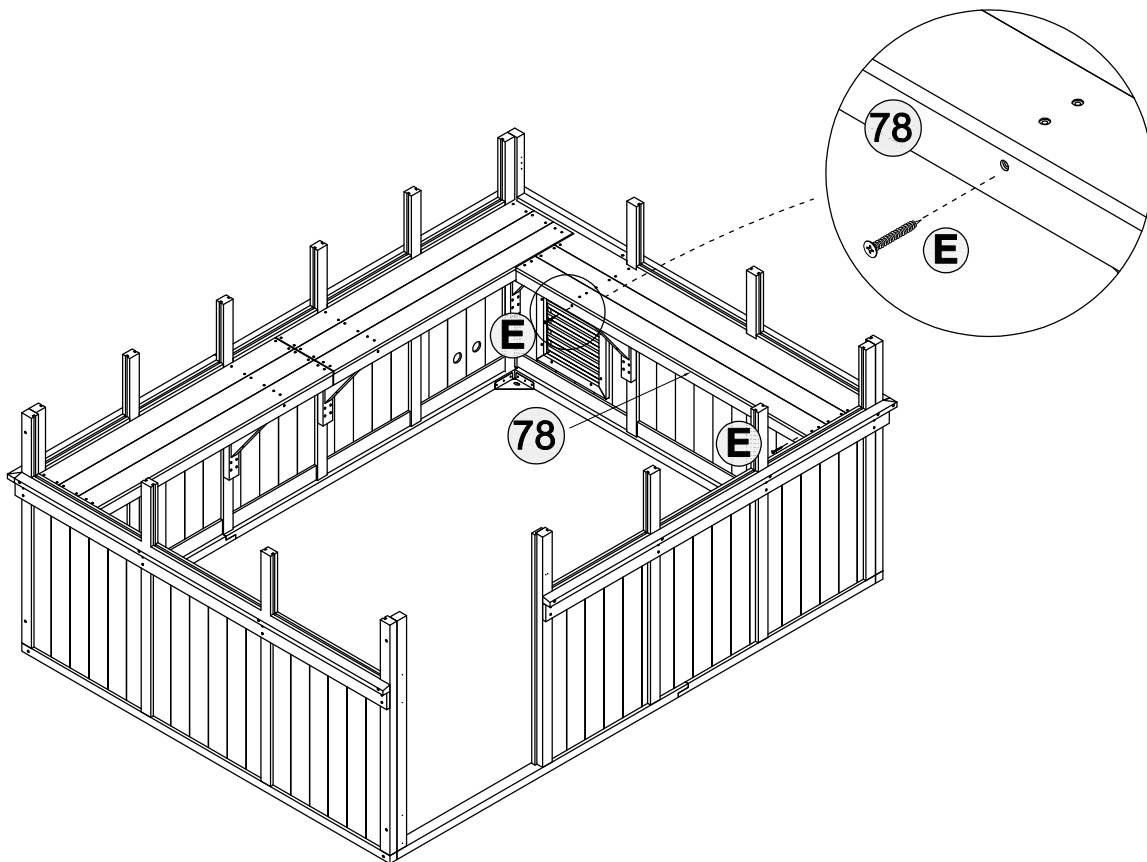

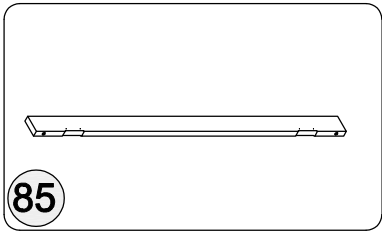

**85**  
Left vertical bar  
Qty: 1



**86**  
Right vertical bar  
Qty: 1

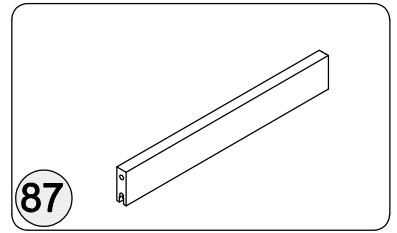

**87**  
Up and down wooden strips  
Qty: 2

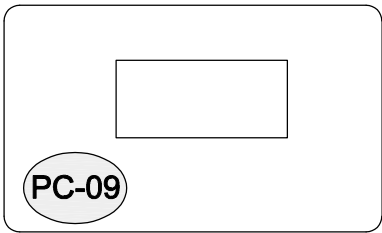

**PC-09**  
Window Sunlight Panel  
Qty: 1

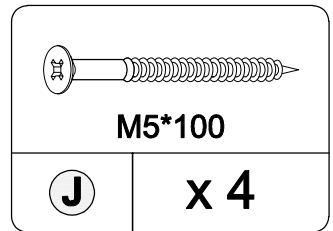
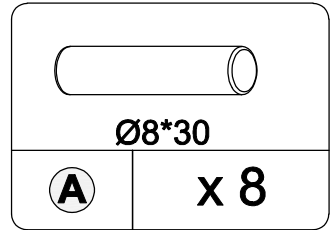

1. Connect with hardware A first, then install with hardware J

 2. Pay attention to the front and back of the components

3. Before installing each PC component, the film should be peeled off first

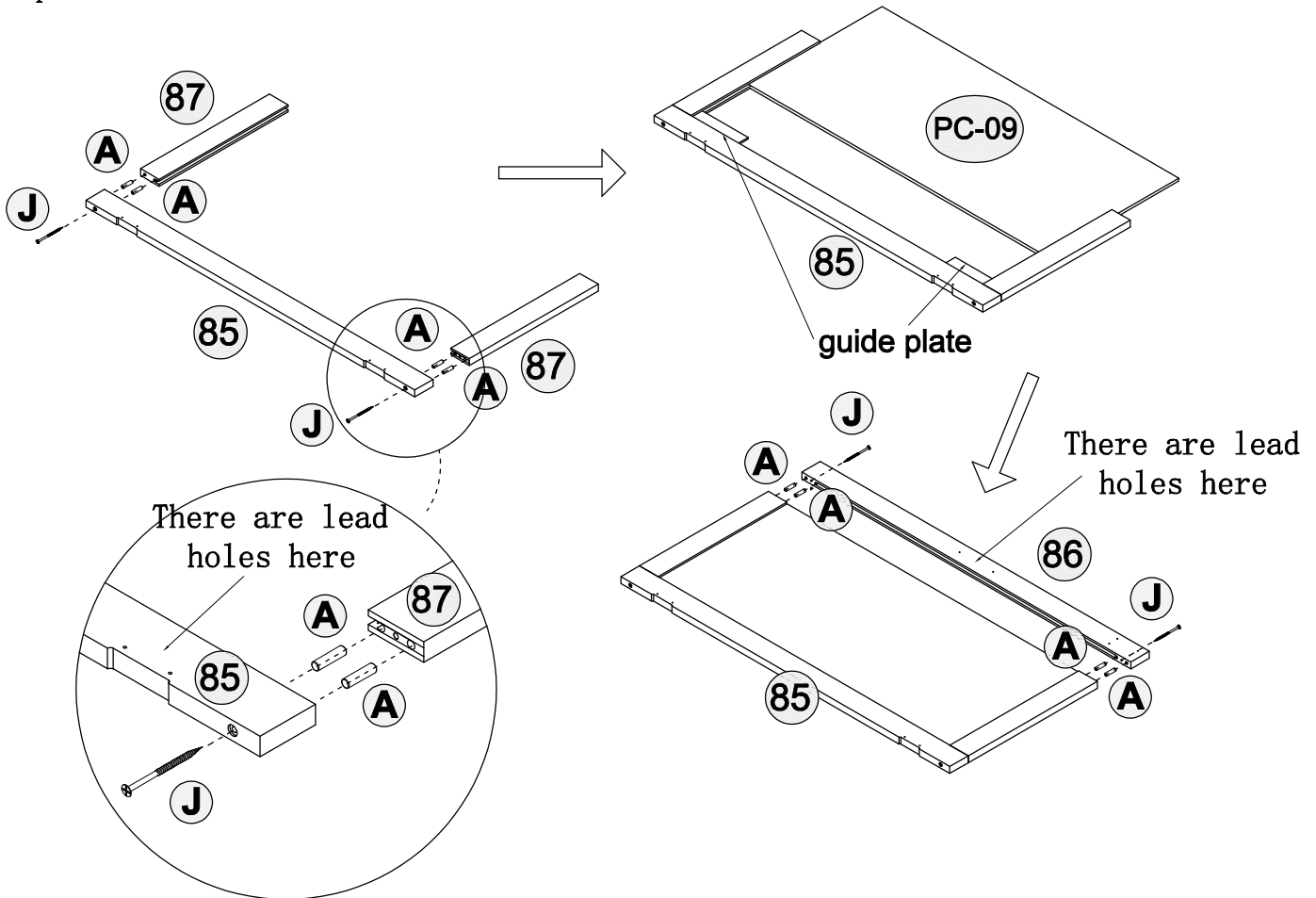

	
M3*16	
<b>B</b>	<b>x14</b>

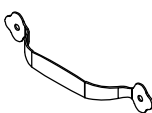
	
<b>Q</b>	<b>x 1</b>

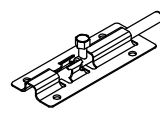
	
<b>M</b>	<b>x 1</b>

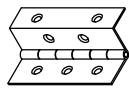
	
L=62	
<b>N</b>	<b>x 2</b>

1. Install hardware onto the lead hole

 2. Pre-install the hardware B for the pilot hole, and then install the other holes of the hardware B.

3. Please note that the hole positions of the pilot holes must be aligned

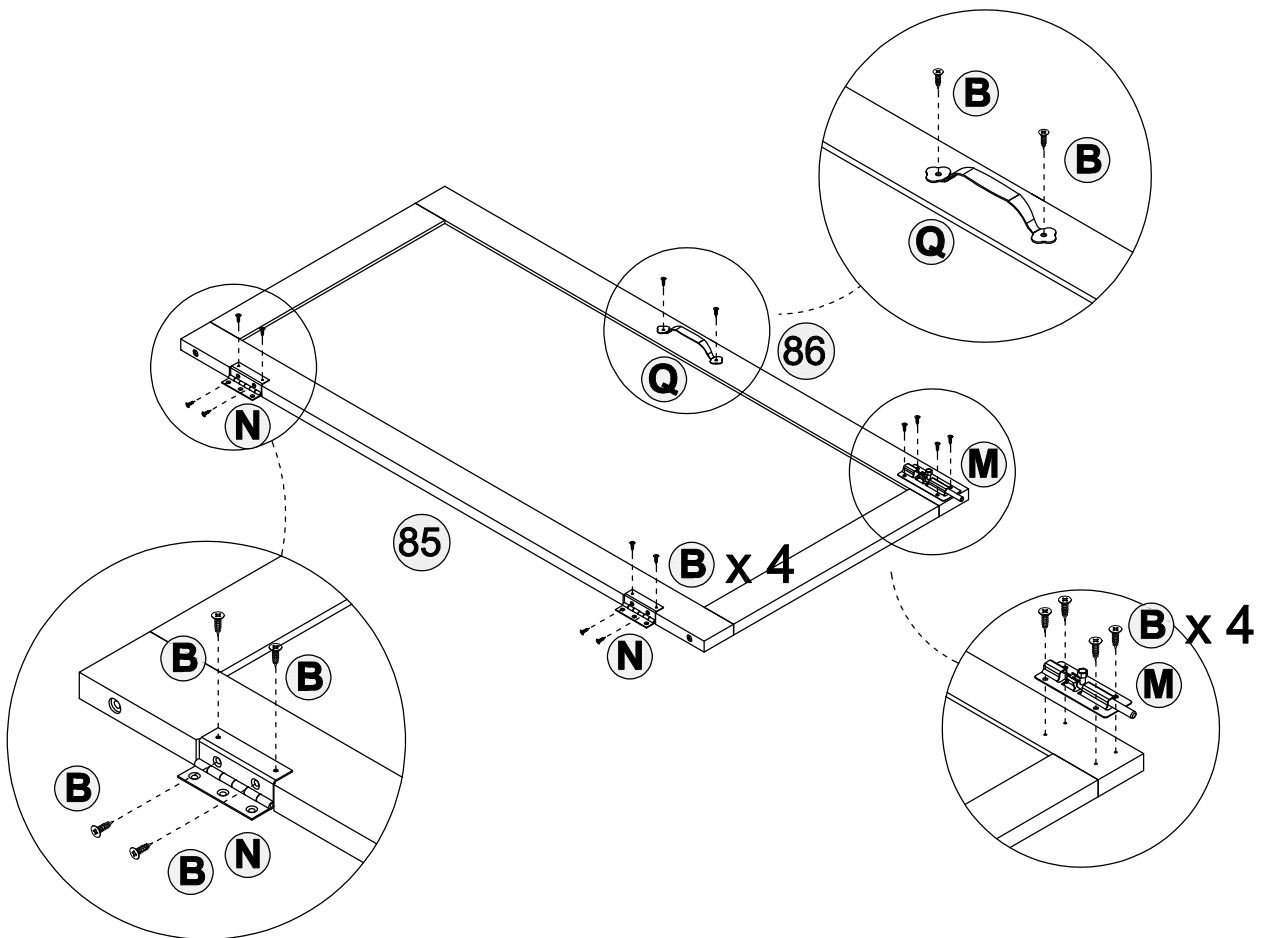

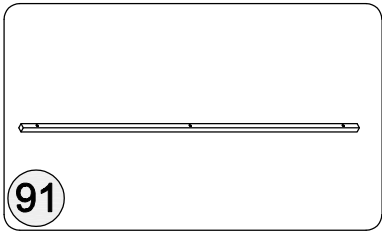

retaining strip  
Qty: 1

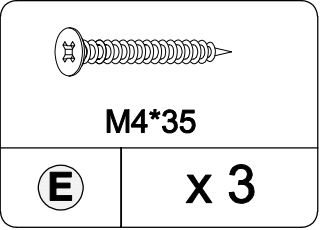
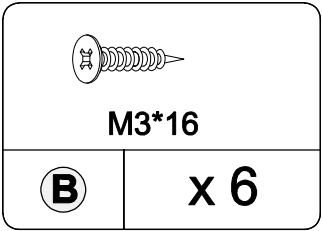

1. Use hardware E to pass through component 91 and install it towards the lead hole

 2. Pre-install the hardware B for the pilot hole, and then install the other holes of the hardware B.

3. Please note that the hole positions of the pilot holes must be aligned

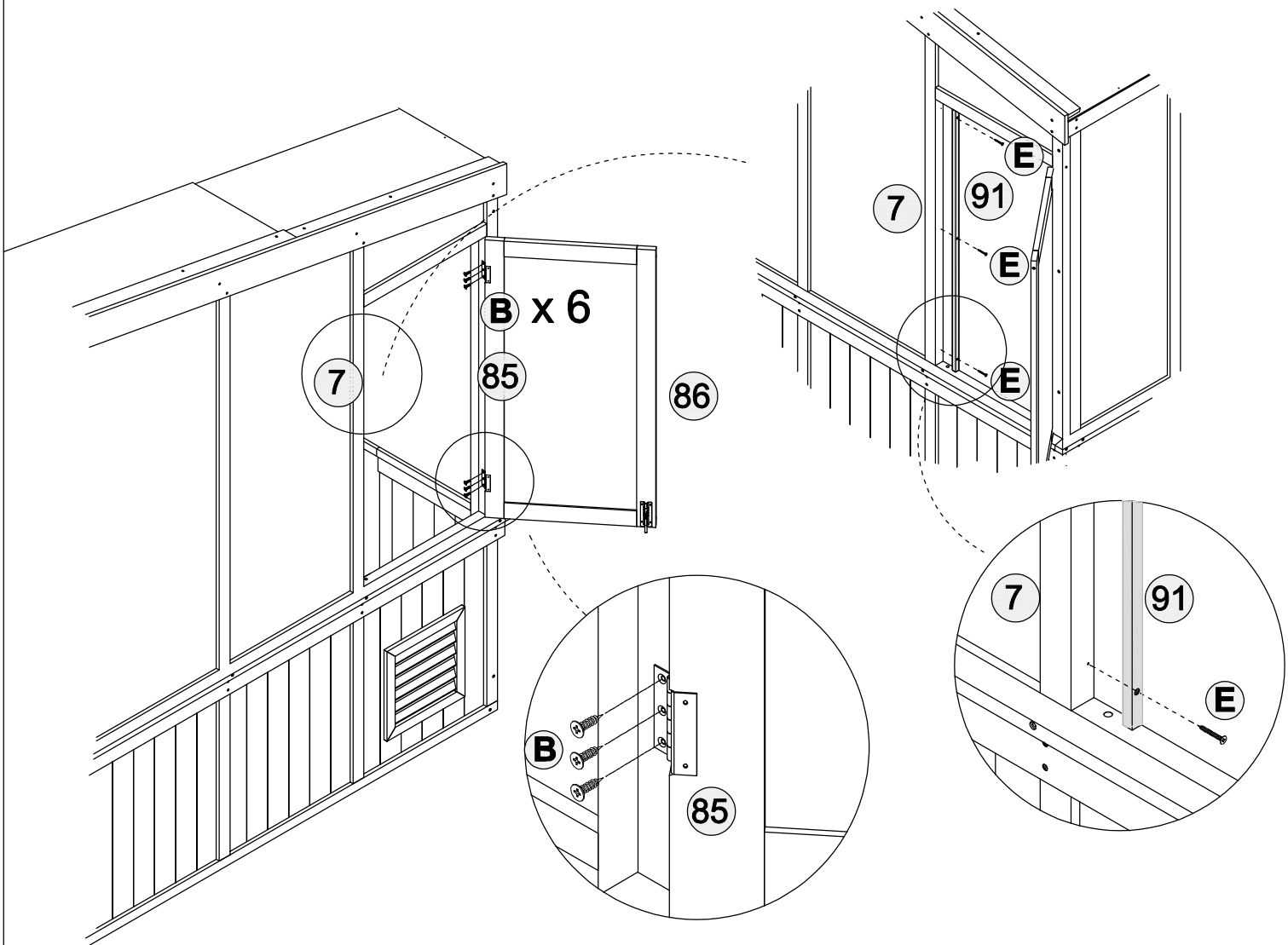

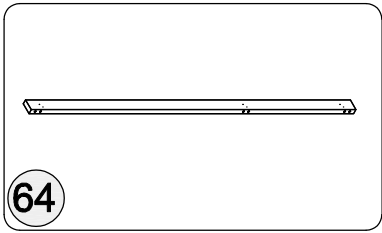

64  
Left door strip  
Qty: 1

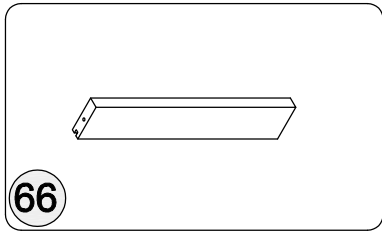

66  
Above the door strip  
Qty: 1

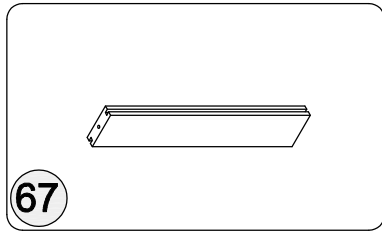

67  
Door side clause  
Qty: 1

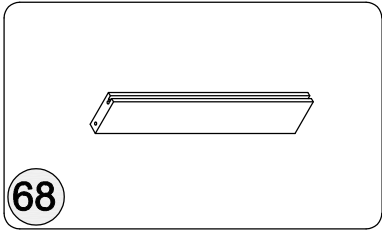

68  
Door bottom strip  
Qty: 1

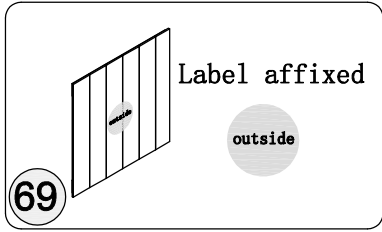

69  
Door core board  
Qty: 1

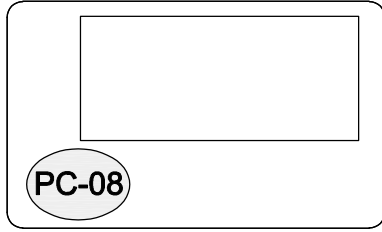

PC-08  
Door Sunshine Board  
Qty: 1

1. Connect with hardware A first, then install with hardware J
2. Before installing each PC component, the film should be peeled off first

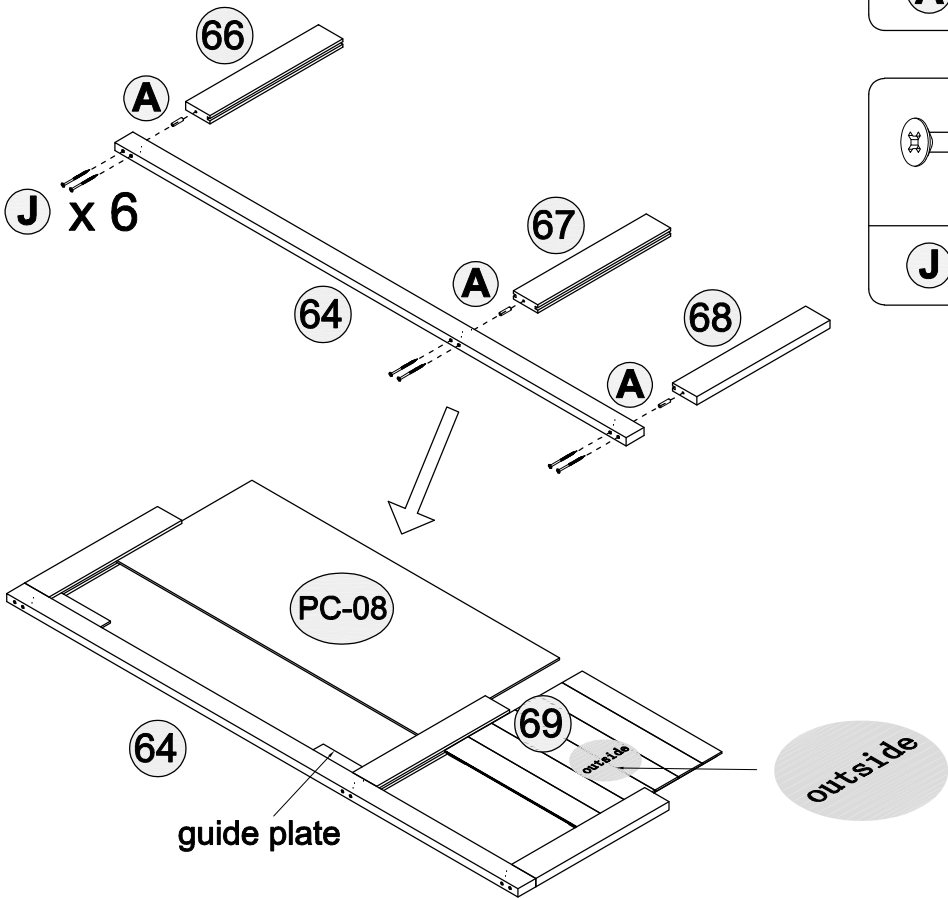
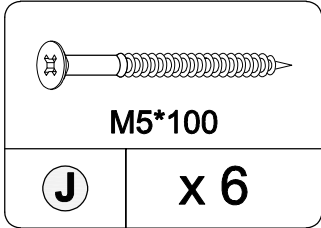
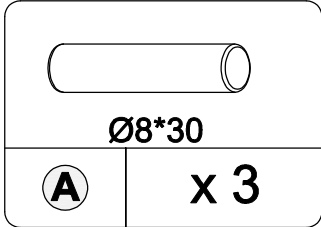

The 2 guide spacers need to be moved to the other side for position when one side is secured.

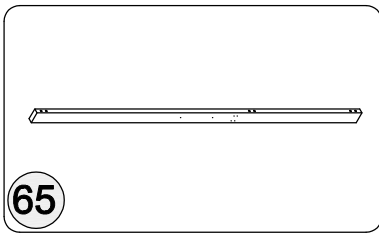

Right door strip  
Qty: 1

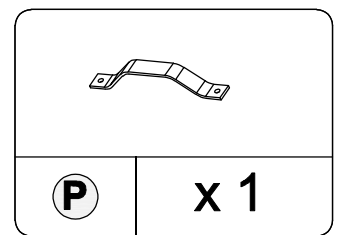
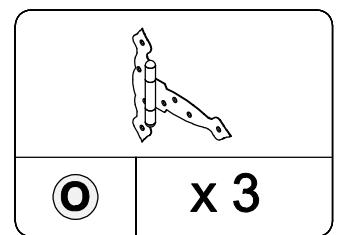
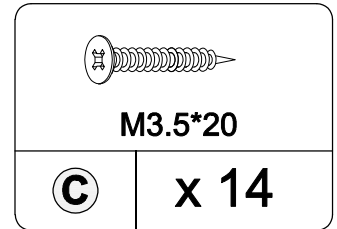
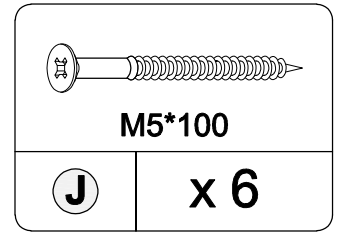
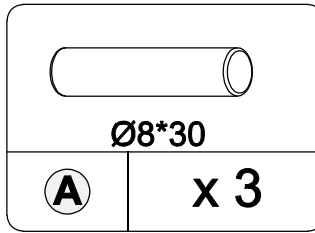

1. Before installing each PC component, the film should be peeled off first
2. Connect with hardware A first, then install with hardware J

-  3. Pre-install the hardware C for the pilot hole, and then install the other holes of the hardware C.

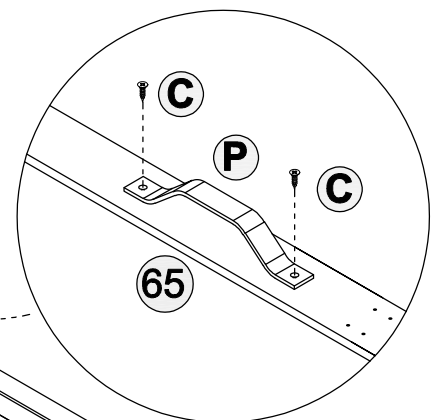
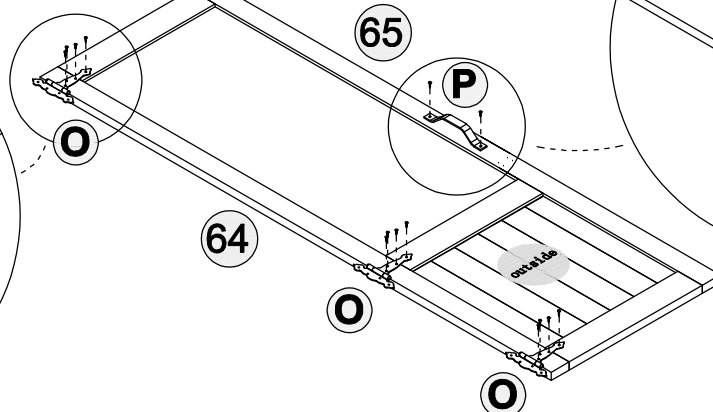
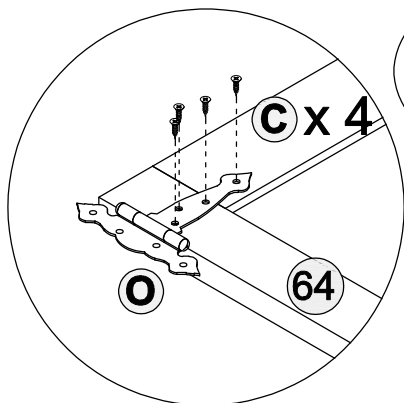
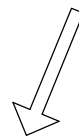
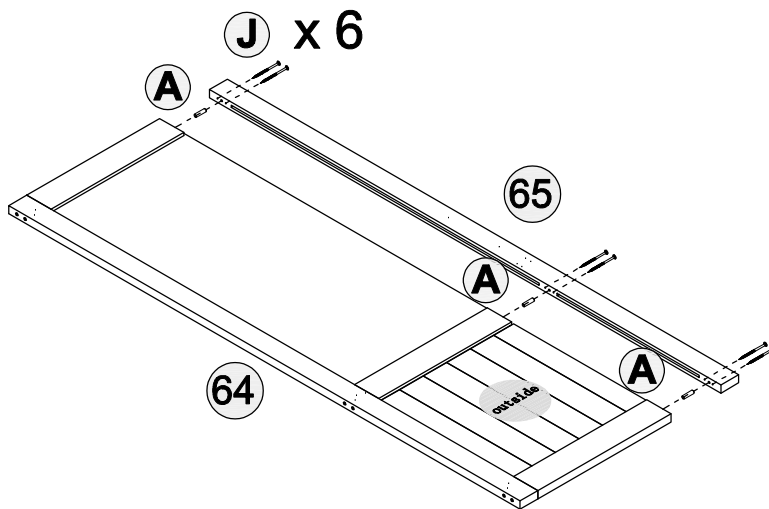

- ⚠ 1. Pre-install the hardware C for the pilot hole, and then install the other holes of the hardware C.
- 2. Please note that the hole positions of the pilot holes must be aligned

	
M3.5*20	
<b>C</b>	<b>x 18</b>

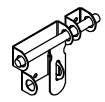
	
<b>R</b>	<b>x 1</b>

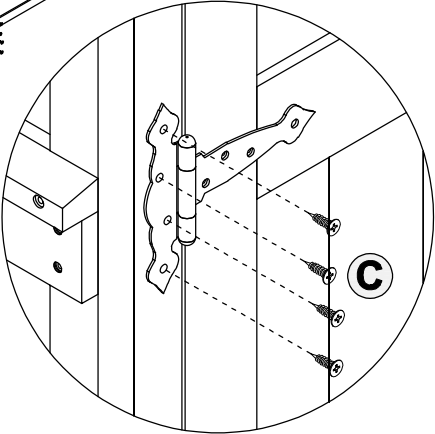
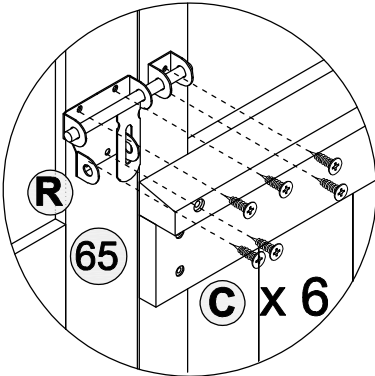
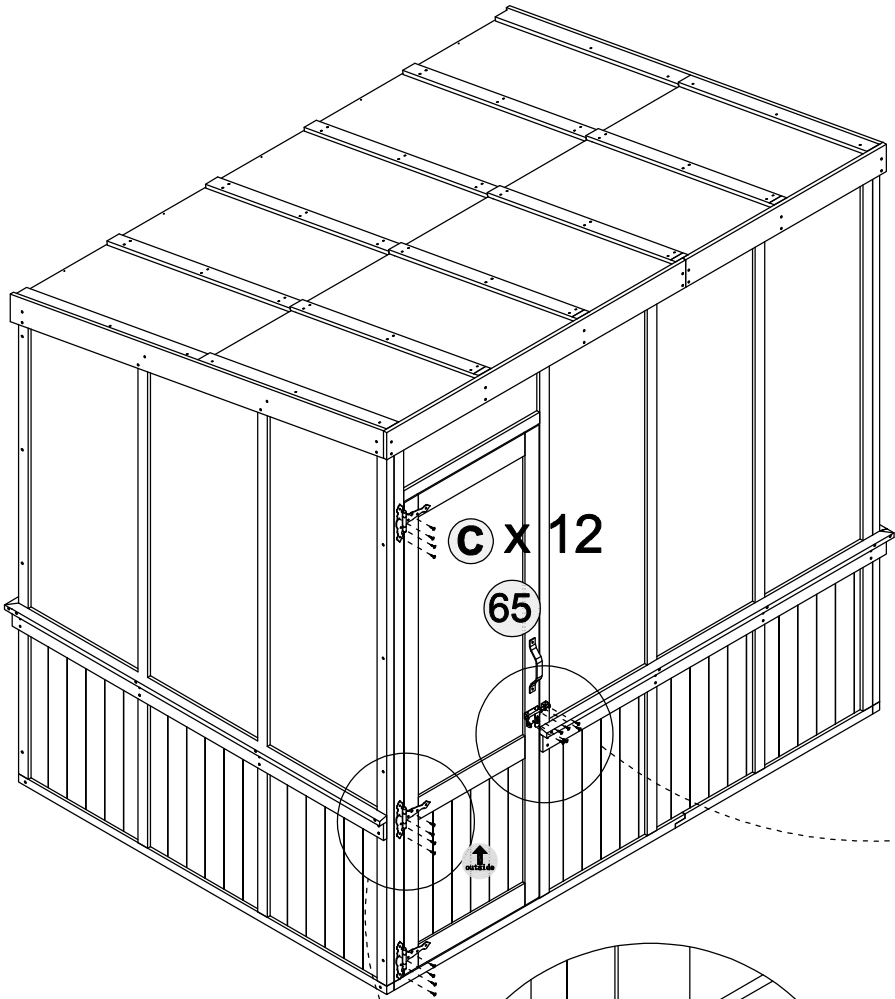

1. Install hardware S behind the door
2. Install towards the lead hole
3. Please note that the hole positions of the pilot holes must be aligned
4. Installation completed

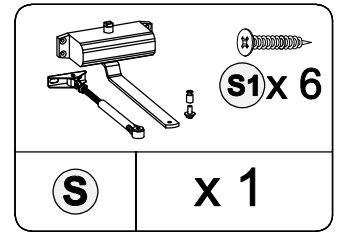

Room door rear pull rod installation

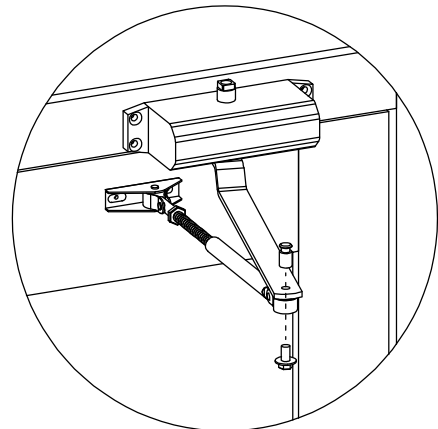
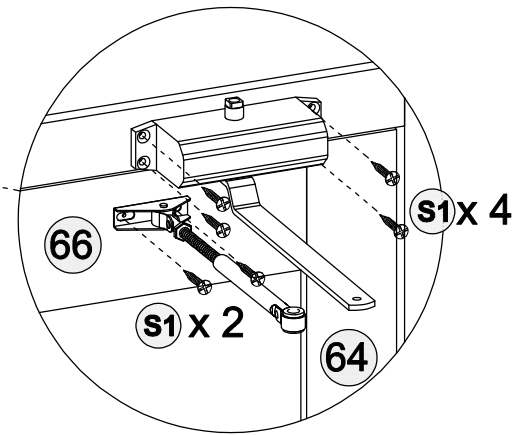
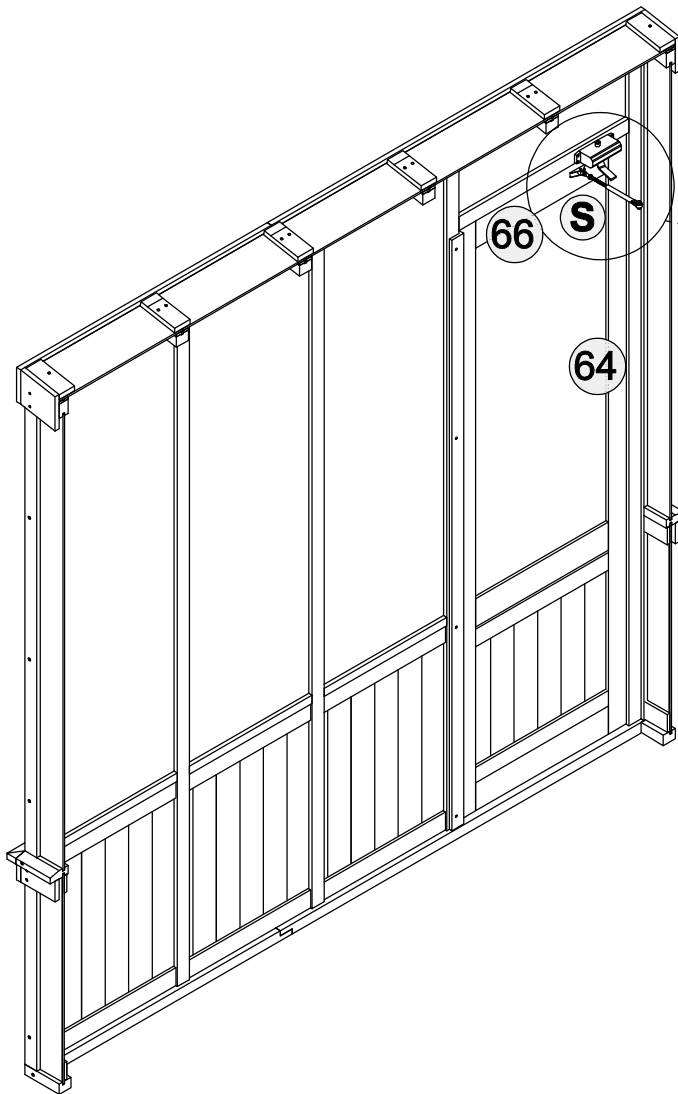

# WARRANTY

## WARRANTY CLAIMS

- There is a 30-day warranty for broken furniture or any other problems that do not work properly. The warranty will start from the date of purchase which must be verified by proof of purchase.
- Before making a claim, we may be able to answer your query, simply call us. Please leave your purchase order number, along with some details of the problem, if you want a replacement part. We will arrange within 48 hours. If there is out of stock, we will reply with a shipping date.
- The product must be used in accordance with the instructions provided. For health reasons.
- For other reasons, if the furniture needs to be returned, it must be cleaned and dried and operated within 30 days of receipt.

## Type of Warranty Claim

- Failure to follow the furniture instructions will invalidate the warranty. Attention please.
- Does not include damage during installation, but includes damage during transportation.

## Scope of responsibility

- Shall not bear any responsibility for misuse or user damage and / or loss of parts during the installation of furniture.
- After using, the damage and scratches of the furniture are not covered by the warranty.

## The Warranty Relates to All Bought in The Us and Covers The Following Areas

- Sheet parts: 1 month from the date of purchase.
- Electrical parts: 1 month from the date of purchase.

# RETURNS

## CHANGED YOUR MIND AND NEED TO RETURN YOU ITEM?

### PLEASE FOLLOW THE BELOW INSTRUCTIONS:

- If you have purchased and have simply changed your mind, follow the retailer's instructions for returns.

### DEFECTIVE ITEMS

- If your item is defective in any way, i.e. it doesn't work but you can't identify why, in the first instance, please call us.

### DAMAGED ITEMS

- If you receive an order with obvious shipping damage from the retailer, then we suggest the delivery is refused. If the delivery has been accepted and then shipping damage is found, please follow the specific instructions advised by the retailer.  
In all circumstances please save all packaging material and paperwork for the order. Please be aware that if you dispose of packaging material or attempt to return the merchandise without contacting the fulfiller, you jeopardise your chances of making a claim, and you may not receive a credit for the return.

### AFTER-SALES CONTACT



adelahu@fufugaga.com



208-820-0068

208-820-0799