

## WARNING

- \* Switch off the main electrical supply from the main fuse box / circuit breaker before installation.
- \* Inspect item carefully before attempting to install.
- \* If there is any damages or obvious defects, do not install.
- \* Item may not be returned once it has been installed.

## CARE AND MAINTENANCE

- \* To clean the outside of the fixture, use a dry or slightly dampened clean cloth (use clean water, never a solvent) to wipe the surface of the fixture.
- \* To clean the inside of the fixture, first disconnect power to the fixture by turning off the circuit breaker or by removing the fuse at the fuse box. Next, use a dry or slightly dampened clean cloth (use clean water, never a solvent) to wipe the interior surface of the fixture.
- \* Do not use any cleaners with chemical, solvents or harsh abrasives. Use only a dry soft cloth to dust or wipe carefully.

## NOTICE& IMPORTANT SAFETY INSTRUCTIONS

- \* Please make sure that you have all parts indicated before you begin assembly of this item
- \* This item should be assembled on a soft surface to prevent scratching the finish during assembly
- \* To reduce the risk of fire, electrical shock or injury to persons or property, please follow the guideline below for safe use and installation
- \*The external flexible cable or cord of this luminaire cannot be replaced  
If the cord is damaged, the luminaire shall be destroyed







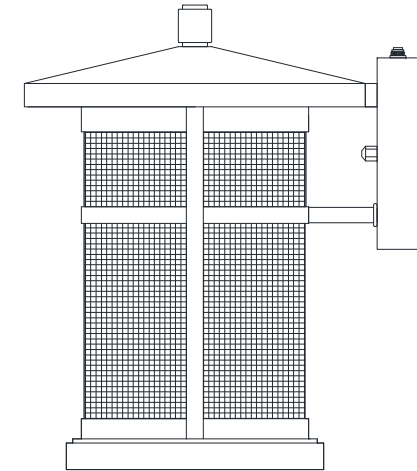







Model#: PLT4029A-SET2

Product Dimensions: 6"L X 7.5"W X 8.5"H



### Part List and Hardware List

PIECE	DESCRIPTION	PICTURE	QUANTITY	PIECE	DESCRIPTION	PICTURE	QUANTITY	PIECE	DESCRIPTION	PICTURE	QUANTITY
A	machine screw		2X	F	rubber ring		2X	K	bulb		1X
B	mounting screw		2X	G	Hexagon nut		2X	L	Lamp body		1X
C	mounting bracket		1X	H	glass shade		1X				
D	ground screw		1X	I	Iron Plate		1X				
E	wire connector		3X	J	M4*L4mm round screw		2X				

## PREPARATION

- \* Before beginning assembly of product, make sure all parts are present. Compare parts with package contents list and hardware contents list.
- \* If any part is missing or damaged, do not attempt to assemble the product.
- \* Estimated Assembly Time: 20 minutes.
- \* Tools Required for Assembly (not included): Screwdriver, Junction box
- \* If you are having difficulty, our friendly Customer Care team is always here to help. Please email [customersupport@safavieh.com](mailto:customersupport@safavieh.com)

**NOTE: PLEASE USE TYPE "A" BULB MAX 40-WATT OR LED BULB MAX 9-WATT, THERE ARE 1PCS LED 4-WATT BULB IN THE BOX**

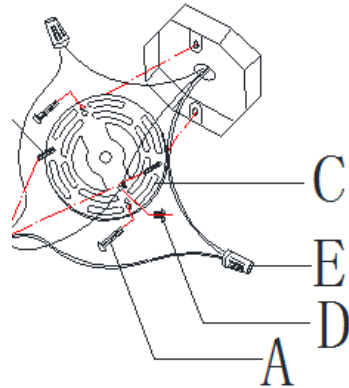

### Step 1:

Install the mounting bracket(C) to the junction box with machine screw (A)

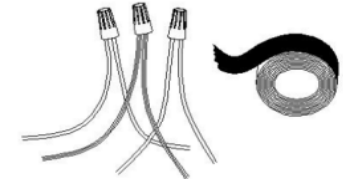
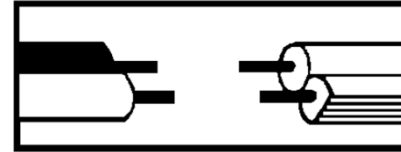

### Step 2:

Make wire connections, with wire nut(E)

Connect fixture neutral wire (ribbed) to the outlet box neutral wire (usually white) using a wire nut. Connect fixture hot wire (smooth with markings) to the outlet box hot wire (usually black) using a wire nut.

CAUTION: Do not reverse the hot and neutral connections

Grounding Instructions:

Wrap ground wire from outlet box around green ground screw(Q) on mounting bracket, no less than 2" from wire end. Tighten ground screw. If fixture is supplied with a ground wire, connect to outlet ground wire with a wire nut.

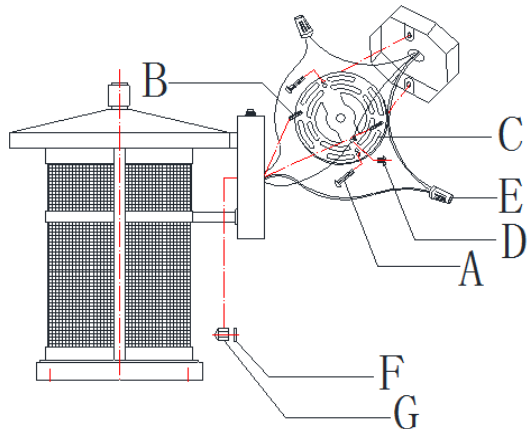

### Step 3:

Attach the Canopy of the Lamp body(L) to the mounting bracket(C) , and secure with rubber rings(F) and screws(B) by turning the Hexagon nut (G) clockwise .

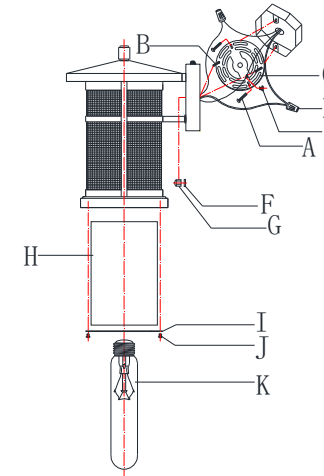

### Step 4:

Put the glass shade(H) on socket and fasten the socket ring(F) to fix it. Insert the bulbs (K) into the socket.