

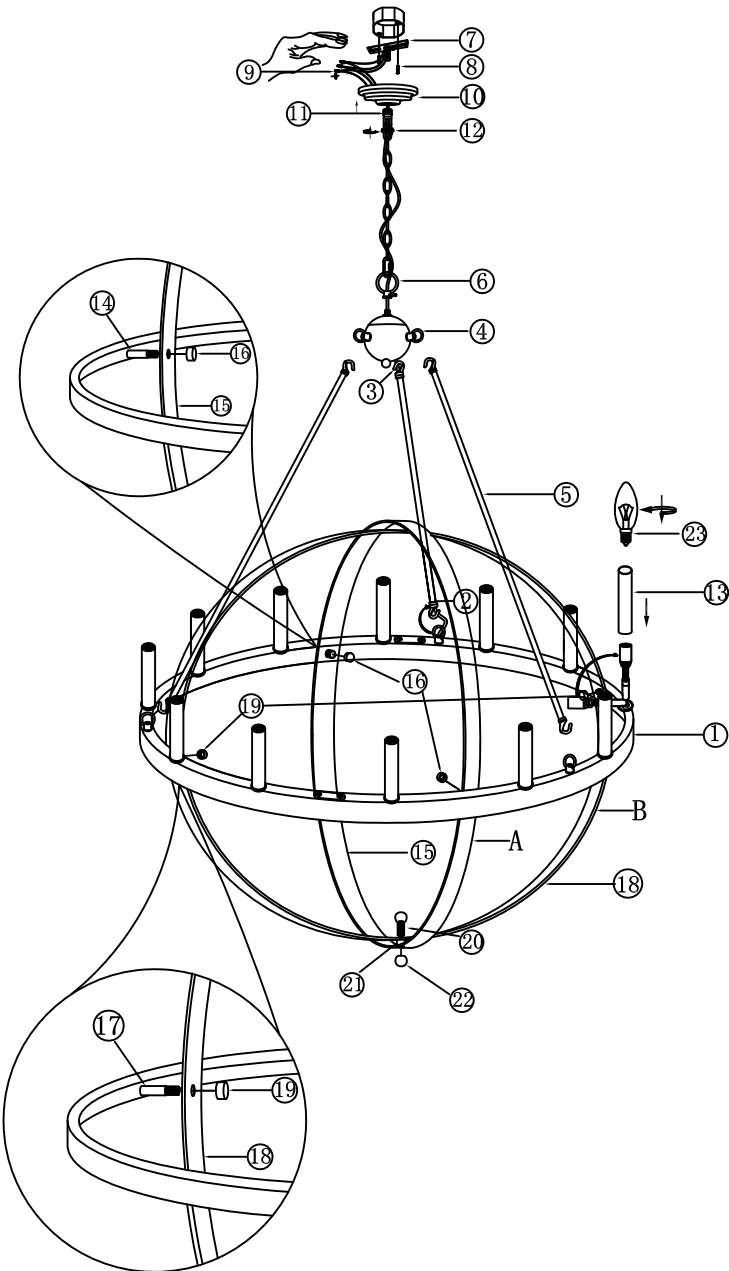











## FIXTURE ASSEMBLY STEPS:

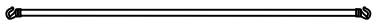

DESCRIPTION	PICTURE	CODE	QTY
Mounting Plate		7	1 SET
Mounting Box Screw		8	2 PCS
P3 Wiring Cap		9	3 PCS
Canopy		10	1 SET
Fixed connecting rod + decorative head (Flat iron ring B)		15 / 17	2 PCS
Fixed decorative head (for the middle)		18 / 19 / 20	1 SET
Fixed connecting rod + decorative head (Flat iron ring A)		14	2 SET
Chain +Flying rings + movable chain link		6 / 11 / 12	1 SET
Derrick Part		5	2 PCS
Black Cable tie			3 PCS
Lamp holder casing		13	12 PCS
Inner Flat iron ring (B)		18	1 PCS
Outside Flat iron ring (A)		15	1 PCS
Lamp Body		1 / 2 / 3 / 4	1 SET
			

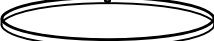
**WARNING** - if any Special Control Devices are used with this Fixture, Follow the instructions Carefully to assure fun compliance With N.E.C. requirements. if there are any questions, contact a Qualified Electrical Contractor.  
**CAUTION** - All glass is fragile, use care when handling Glass component(s) and or Lamp(s).  
**WARNING** - This product contains chemicals known to the State of California to cause cancer, birth defects and /or other reproductive harm. Thoroughly wash hands after installing. handling. cleaning, or otherwise touching this product

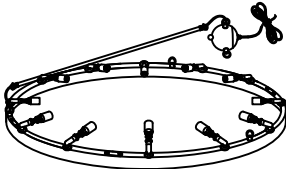
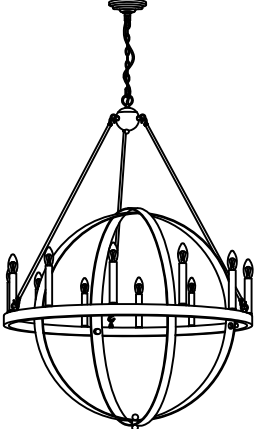
**CANOPY MOUNTING & WIRE CONNECTION ASSEMBLY STEPS:**

Attach(N),(P) to achieve overall desired length.  
 Una (N),(P) para lograr la longitud deseada.  
 Joignez(N),(P) pour obtenir la Longueur voulue.

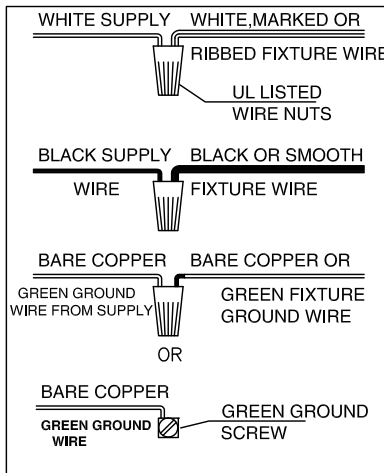

**FIXTURE ASSEMBLY STEPS:**

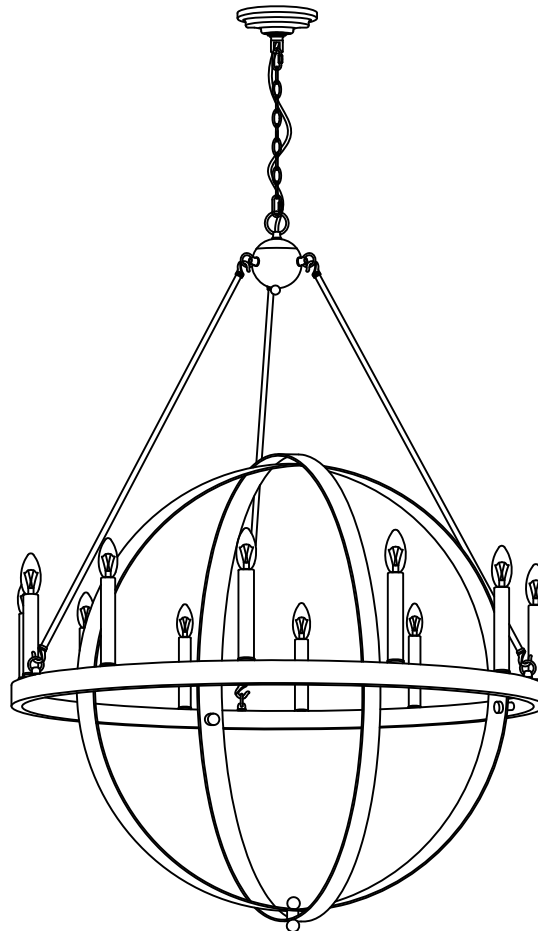

110-120V / 60Hz  
 E12 12\*MAX 60W TYPE B  
 (Do not contain light bulb)

1. AC110~120V,50~60Hz.The Max lamps power is 60W TYPE B Bulb.
2. Avoid to scratch the surface of lighting and the wires when install it.
3. Connect the live wire with the white wire, the natural wire with the parti-colored one, the earth one with the earth symbol (L-L,N-N).
4. Don't install it to the ceiling before it's completely dry, the surrounding around must be ventilated and dry.
5. Keep away from the acid, basicity objects and gases, clean with soft cloth, water washing is not allowed.
6. Be careful when you install glass lamp shade
7. The lighting must be installed by professional electrician and used indoor only.
8. Please keep attention to cut off the power supply when installing, cleaning, and replacing bulb.

## FIXTURE ASSEMBLY STEPS:

# 1

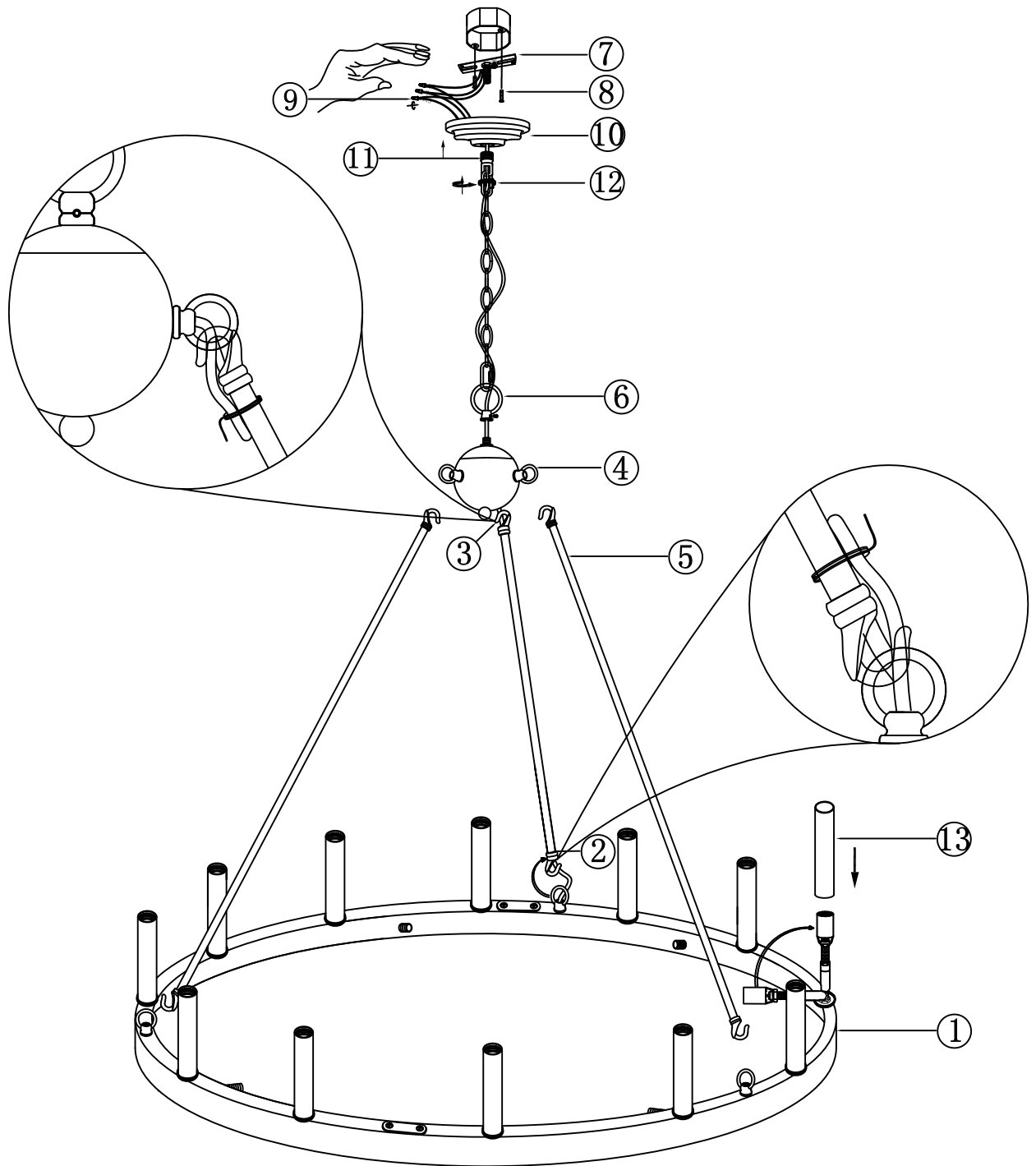

## Installation Precautions:

1. Please assemble the lamp body according to the sequence and installation steps;
2. Install large flat iron ring first (A) Fixed tightly ;
3. Then fix the small flat iron ring (B) Fixed tightly ;
4. This lamp is relatively heavy, 2-3 people are recommended to install;
5. In the installation process, the two rings can not collide, easy to drop paint, scratch.

2

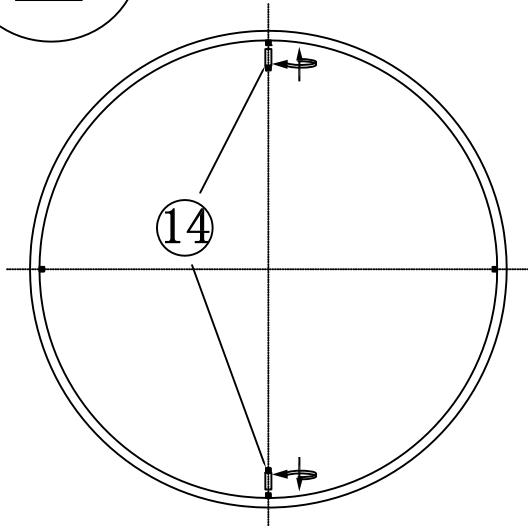

3

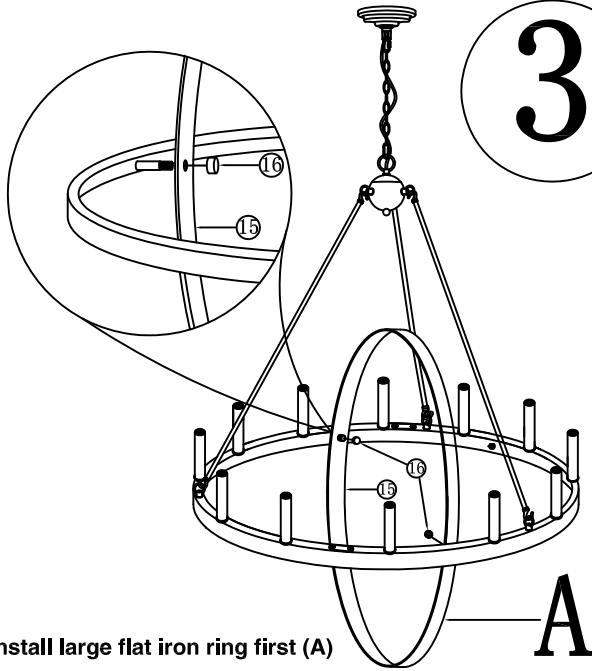

Install large flat iron ring first (A)

A

4

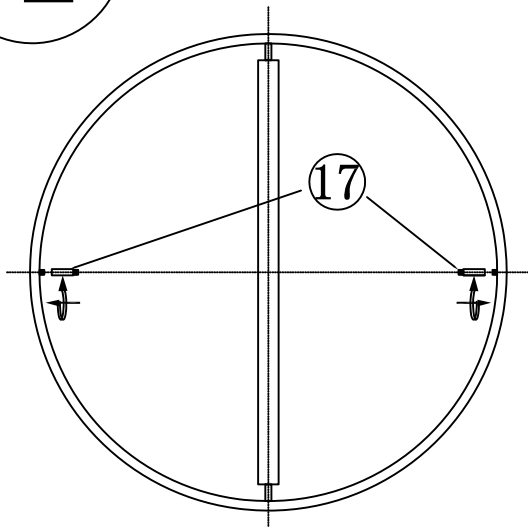

5

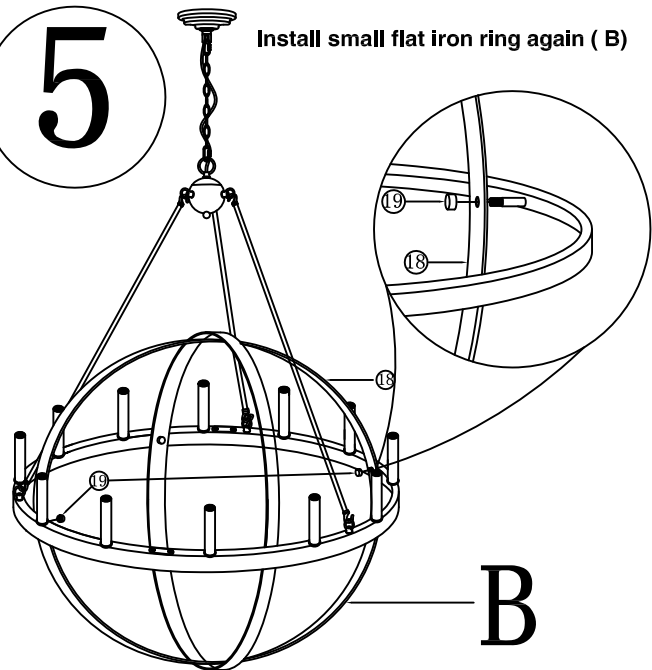

Install small flat iron ring again (B)

B

6

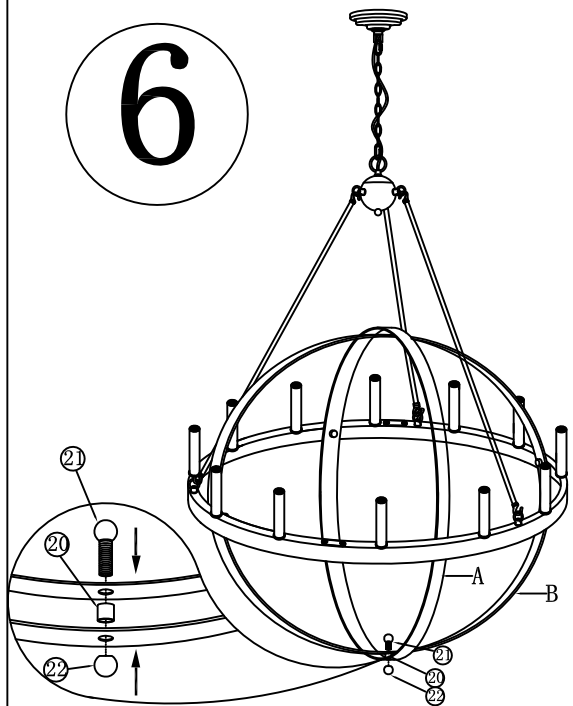

7

