







(A) ×16

 M8×30

(B) ×4

 M8×70

(C) ×8

(D) ×8

 M8×70



(E) ×12

 M6×80

(F) ×1

 M4

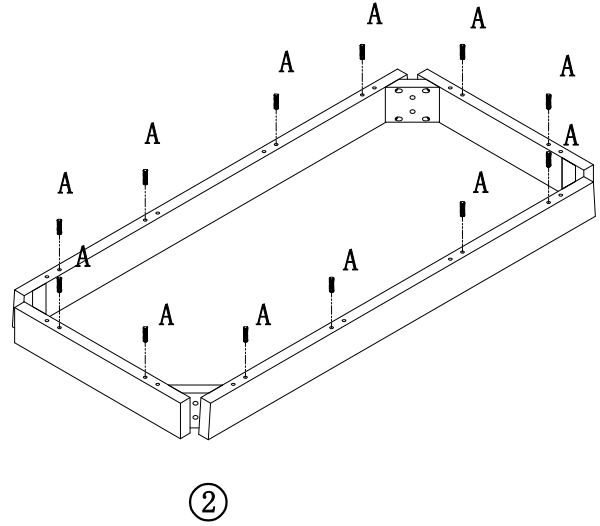
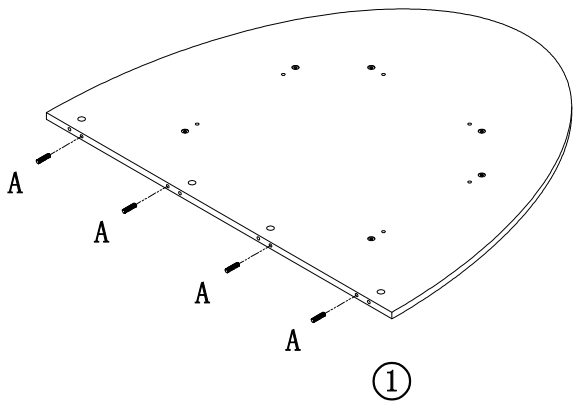
(G) ×1

 M5

1

(A) ×16
M8×30





2

(B) ×4

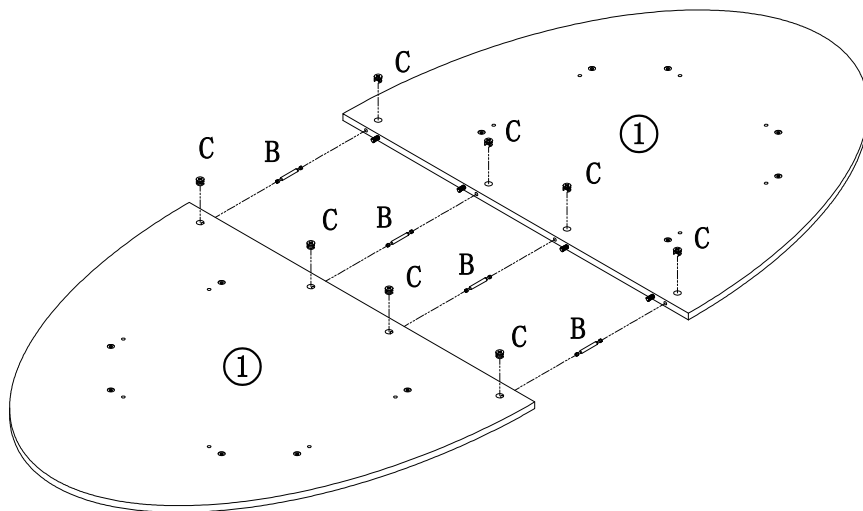

(C) ×8



3

(E) ×12
M6×80

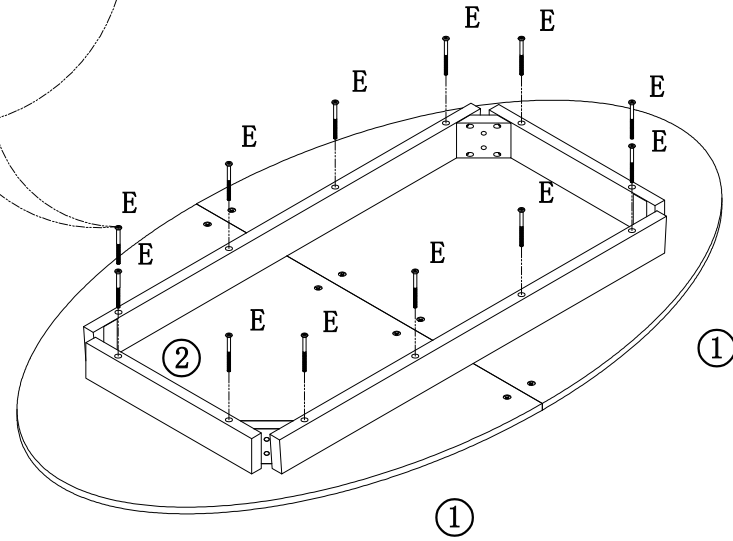
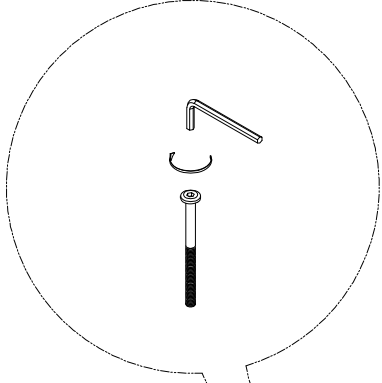

(F) ×1
M4

4

(D) ×8
M8×70



(G) ×1
M5

