







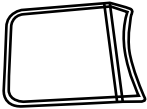

# Assembly Instruction

## Parts List:

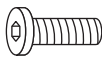
NO.	part	Diagram	Qty pcs
A1	Left Arm		1
A2	Right Arm		1
B	Chair Back		1
C	Seat Panel		1
D	Bolts	 M6*38mm	10
E	Washers		10
F	Seat Cushion		1
G	Back Cushion		1
H	Wrench		1

For any missing or damaging parts, hardware, or any other problems, WELCOME to email us

\* Don't fully tighten all the bolts till the very end!

### PRE-ASSEMBLY PREPARATION:

--- Please read through the instructions before beginning assembly.

--- Clear out the space for assembly and lay out all of the parts based on the Parts List, extra room will allow you to easily determine if all the pieces are present.

--- Keep small parts and pieces away from children until fully assembled.

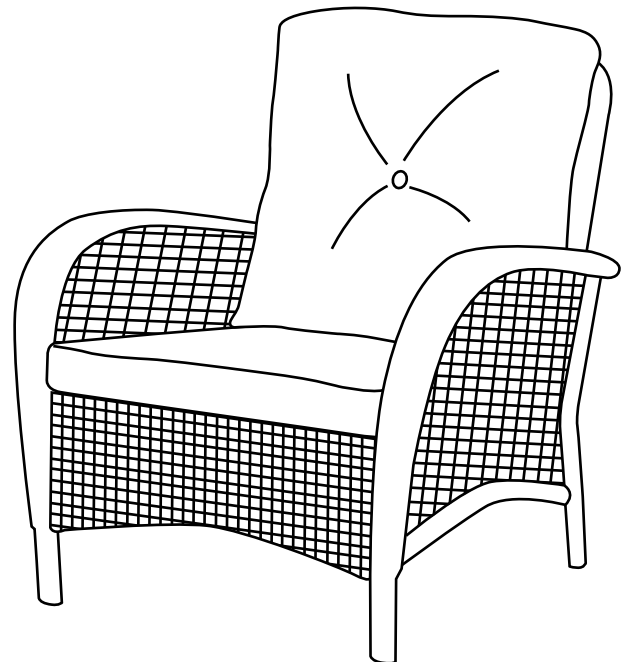

# Assembly Instruction

## Step 1

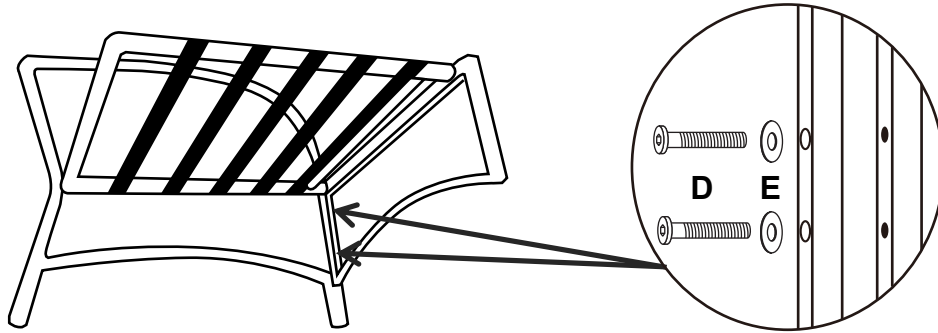

Attach left, right arms and seat panel with D and E. Don't tighten bolts!

## Step 2

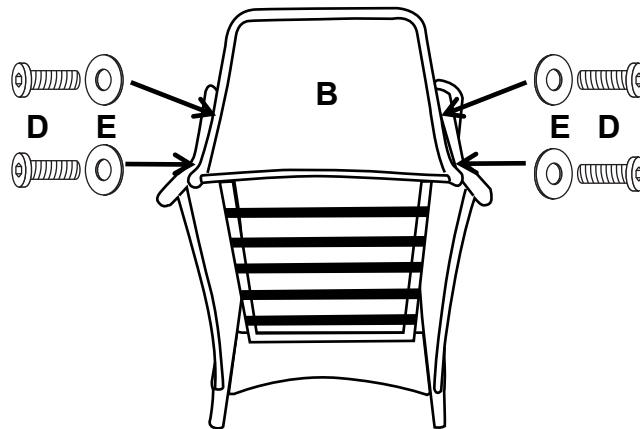

Attach left, right arms and back panel with D and E. Don't tighten bolts!

## Step 3

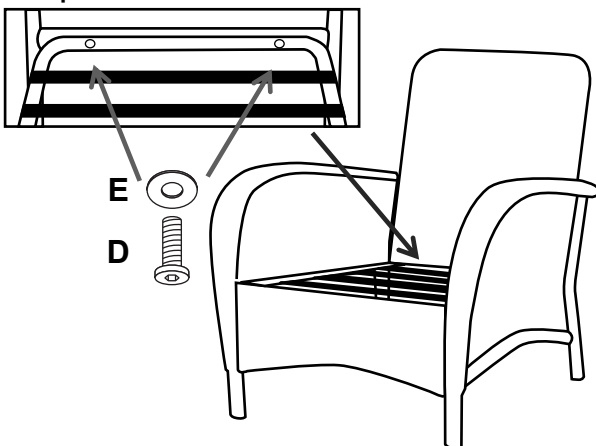

Attach seat and back panel with D and E. Verify the alignment and adjust. Now fully tighten all the bolts using wrench (H).

## Step 4

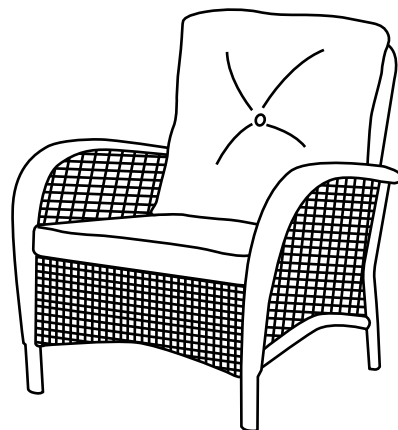

Put the seat cushion (F) and the back cushion (G) on the chair.

The chair is full assembled now.