

ASSEMBLY INSTRUCTIONS

LIVERPOOL - BAR TABLE

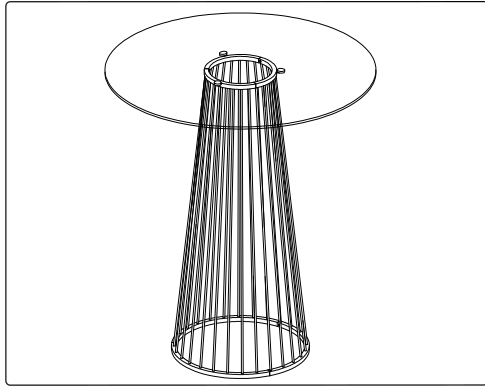

+ Do Not Use Power Tools



+ Suggested Adults



- 1 Read instructions cover to cover.
- 2 Save all packaging until assembly is completed.

1 IMPORTANT SAFETY INFORMATION

Do not assemble the product if the following part arrives damaged:

Part # **①** - Table Top

Tempered Glass Warning : Should the tempered glass chip at ANY point throughout ownership, please immediately discontinue use of the table to avoid injury.

CAUTION : DO NOT place hot objects (100°F or more) directly on the glass surface.

2 IMPORTANT ASSEMBLY INFORMATION

Assembly Step ① Use Bolt A, to connect Part **②**.

Assembly Step ② Use Bolt B, to connect Part **②**, to Part **①**.

+ Parts Included

- ①** Table Top
(# **①** of 1 pc)

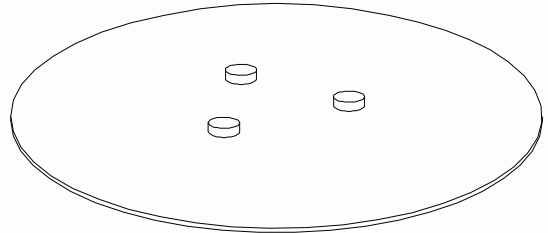

- ②** Legs
(# **②** of 3 pcs)

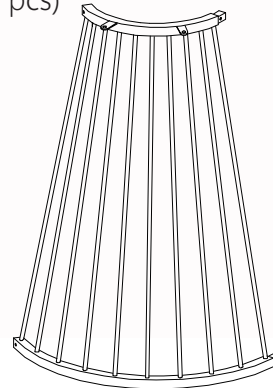

+ Hardware Included

- A** Bolt
(# A of 6 pcs)

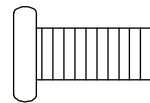

- B** Bolt
(# B of 3 pcs)

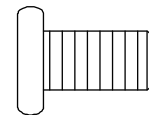

- C** Washer
(# C of 3 pcs)

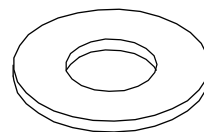

- D** Allen Key
(# D of 1 pc)

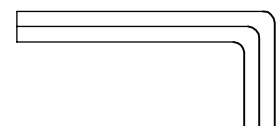

ASSEMBLY INSTRUCTIONS

