

User's Manual

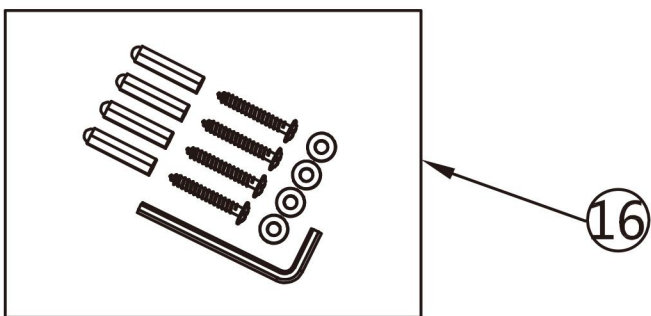

BEFORE INSTALLATION

NO.	Item	Qty
1	Inner joint	2
2	Wall decoration cover	2
3	Shower arm	1
4	Rain shower head	1
5	Screw	6
6	Embedded box	1
7	Panel	1
8	Decorative cover	1
9	Water divider	1
10	Switch handwheel	1
11	Decorative cup	1
12	Hand shower seat	1
13	Shower hose	1
14	Hand shower bracket	1
15	Hand shower	1
16	Accessory bag	1
17	Spout	1

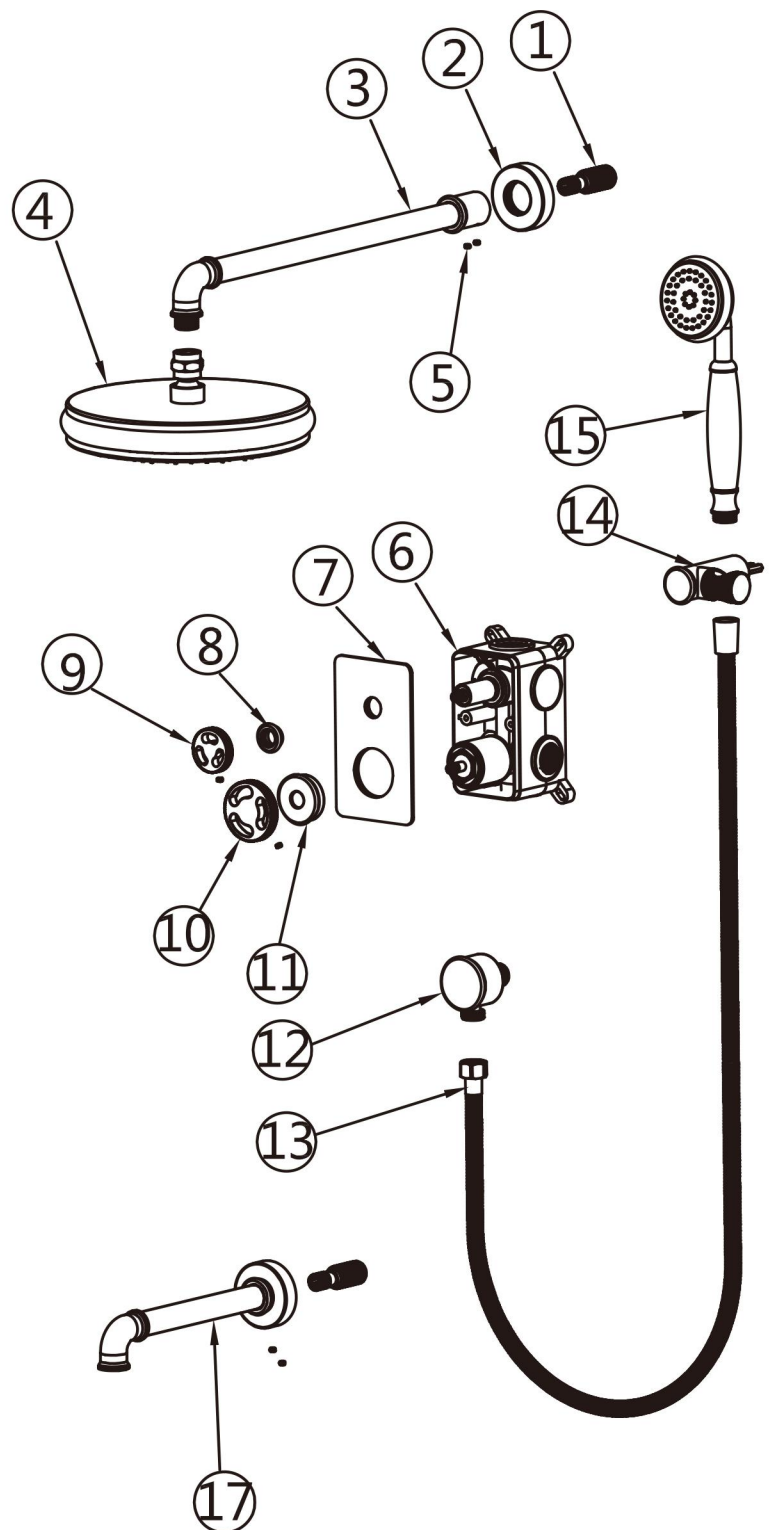

Check accessories

Standard List of Accessories:

When you open the product packaging, please check whether the objects in it are consistent with the main body and accessories you purchased. If there is any inconsistency, please contact our company or our distributor.

Note: 1. Accessories are subject to change without prior notice if the change does not affect usage;

2. The appearance of the product is subject to the physical objects you receive, and the schematic diagram is only for reference.

INSTALLATION STEPS

This product has been inspected and debugged by the factory to the best condition. Please do not disassemble and assemble it yourself.

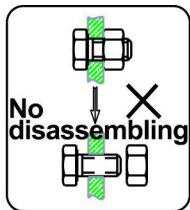

Before installing the product, please be sure to remove sundries and sludge from the water pipe to prevent sundries from blocking the product.

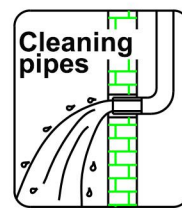

1. Waterway display map

- 1). The minimum opening size of the wall box is 6.3"x3.94", the depth is 2.56"~2.83", and the depth is less than 2.83" is the best (Note: The depth dimension is the size of the tile attached to the wall. If it is installed on the wall, please reserve the appropriate tile thickness)
- 2). Please flush all pipes before installation.
- 3). Special attention must be paid to the hot and cold water pipes of the embedded box: the left side is hot water, and the right side is cold water.
- 4). After the water test is completed and it is confirmed that there is no leakage, cement packing can be used to seal the pipeline and the embedded box.

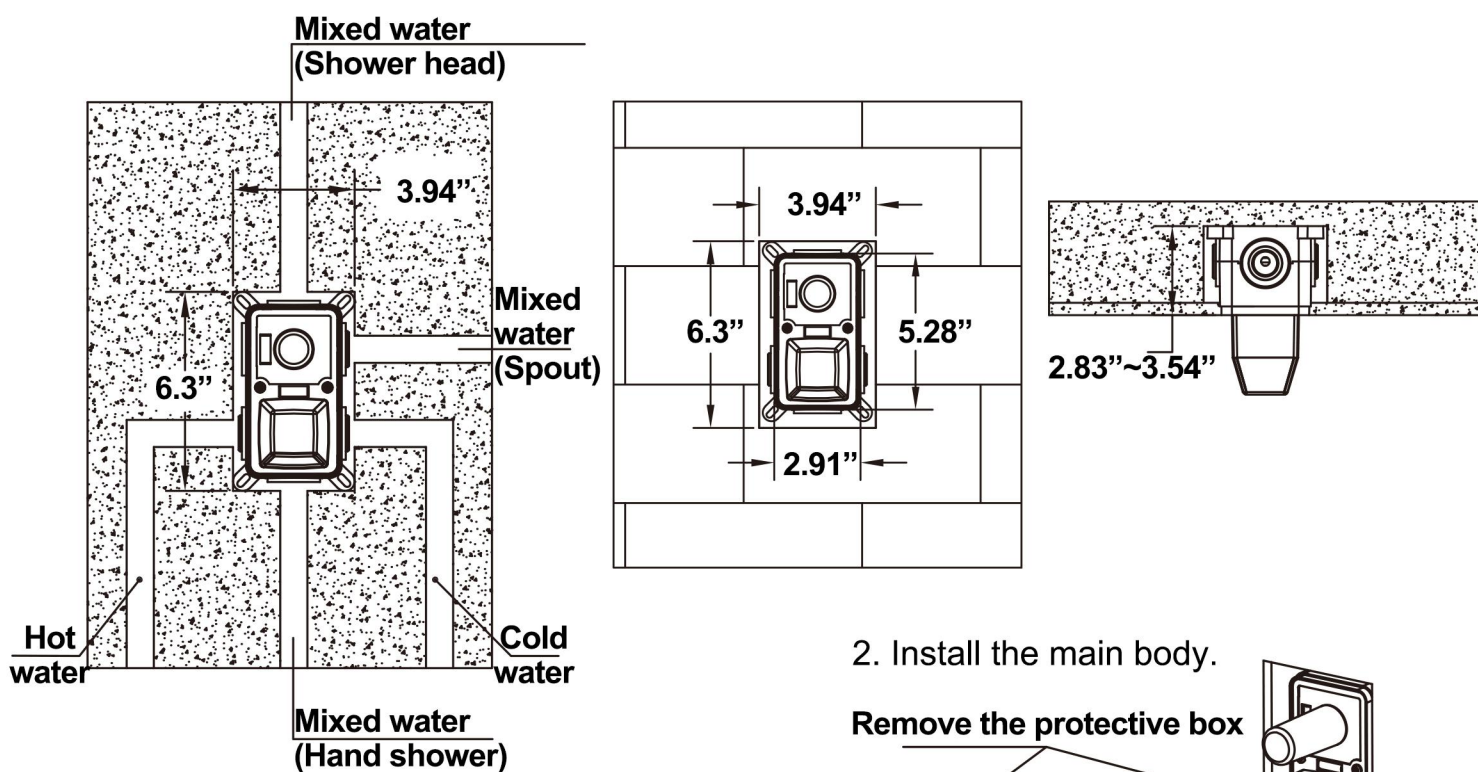

2. Install the main body.

Remove the protective box

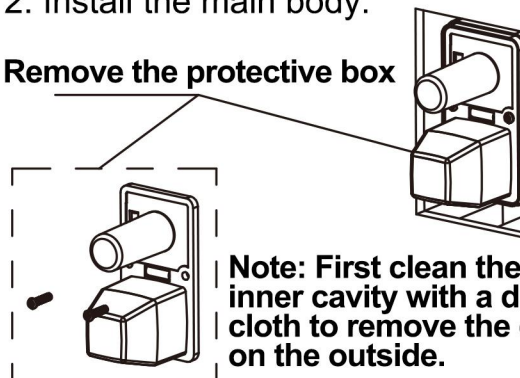

3. Install the upper outlet pipe and the top shower head. (wrap the PTFE tape on the thread)

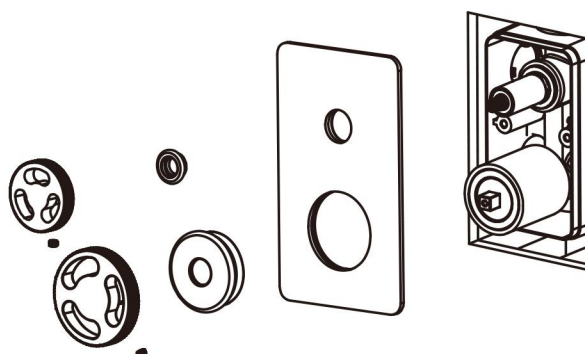
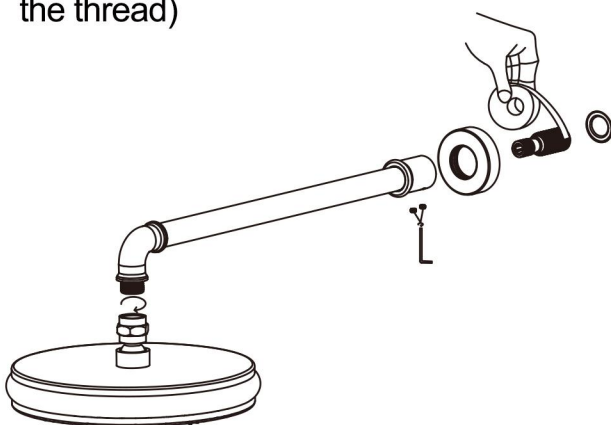

INSTALLATION STEPS

4. Install the hand shower bracket (wrap the PTFE tape on the thread) and the shower seat.

5. Install the spout.

6. Schematic diagram of product installation completed.

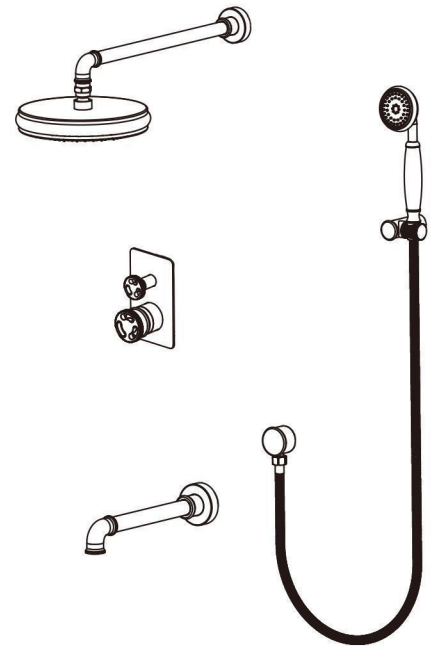
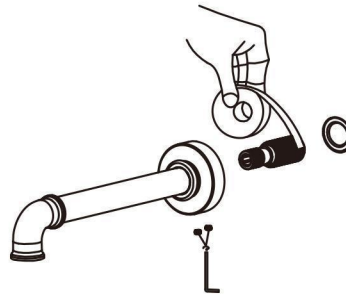
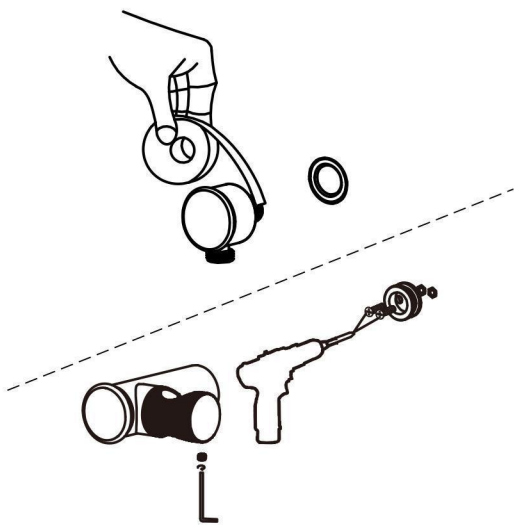

INSTALLATION DIMENSION

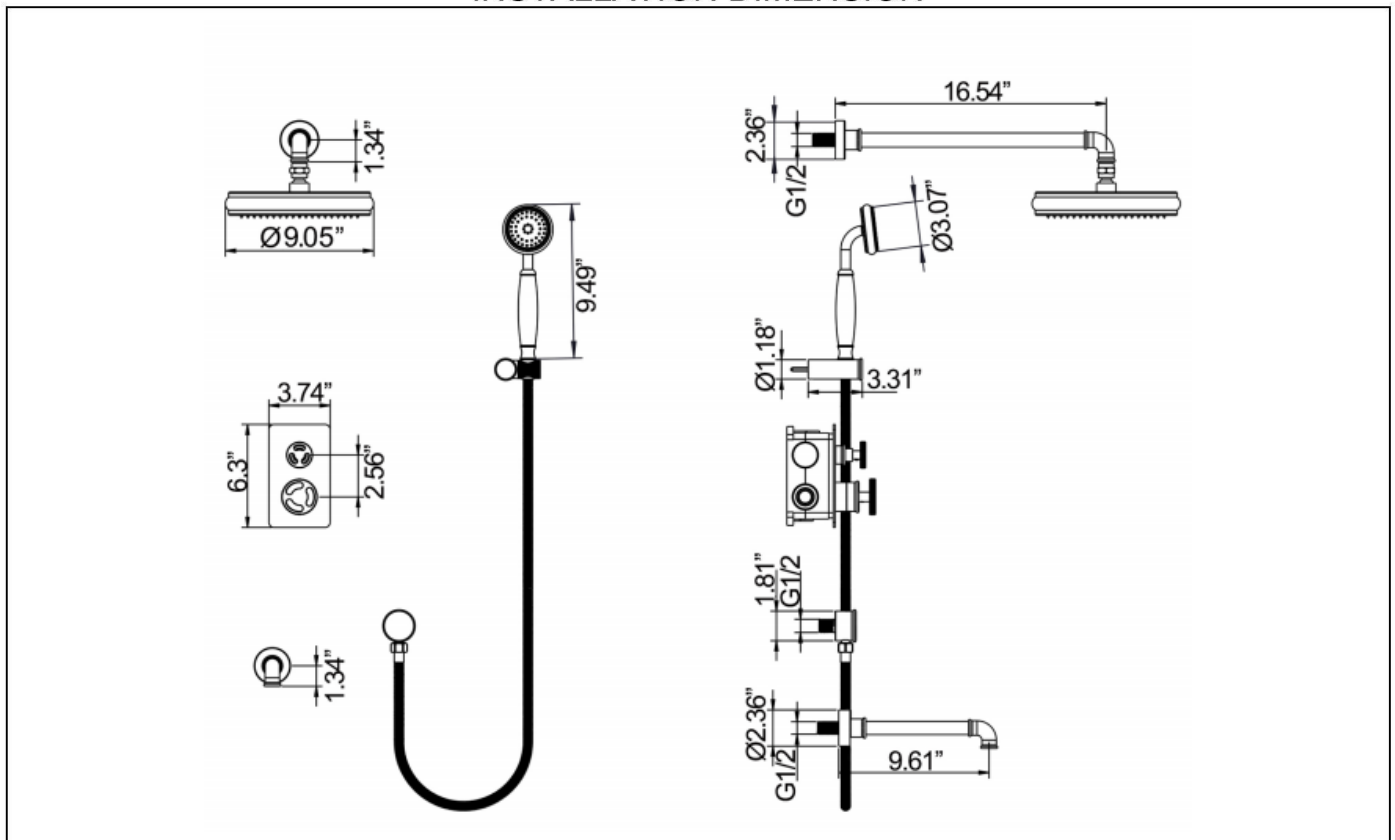

CLEANING CARE

In order to keep the appearance of product clean, bright and good performance, please take care of the product as follows;

1. Rinse with water only and dry with soft cotton cloth;
2. Use mild liquid and colorless glass cleaner to remove surface dirt and scale film, or use polish without abrasive effect;
3. Do not use abrasive detergent, polish, emery cloth, paper towel or scraper, etc;
4. Do not use acid cleaner, or cleaner and soap with insoluble gran etc;
5. In the process of use, mud may accumulate in the bubbler and make the water flow show, The bubbler can be unscrewed, rinsed with water, and then installed back in place.



