



Russell Hobbs

Operating Manual

ATLAS²

RHCV3101 / RHCV3601

ASSEMBLY & POWERING ON

SURFACE COMPATIBILITY

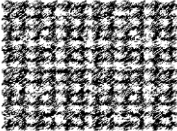
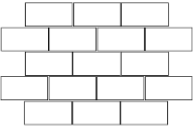
	
Carpet	Hard Floors

GUARANTEE

At Russell Hobbs, we take all our customer feedback seriously.

Feel free to contact our Customer Services Team who will be more than happy to assist you.

This product is guaranteed for 12 months from the date of the original purchase. If any defect arises due to faulty materials or workmanship, the faulty product must be returned to the place of purchase.

Refund or replacement is at the discretion of the retailer.

The following conditions apply:

- The product must be returned to the retailer with the original proof of purchase.
- The product must be installed and used in accordance with the instructions contained in this instruction guide and any other instructions for use which are supplied.
- It must be used for domestic purposes only and for its intended use.
- This guarantee does not cover wear and tear, damage, misuse or consumable parts.
- This does not affect your statutory rights.

Region	Contact	Website
UK & Northern Ireland	0345 209 7461	mda.russellhobbs.com
Ireland	1 800 938982	ie.mda.russellhobbs.com
Rest of Europe	europe@productcaregroup.com	de.mda.russellhobbs.com fr.mda.russellhobbs.com es.mda.russellhobbs.com it.mda.russellhobbs.com nl.mda.russellhobbs.com

Note your serial number below for future reference



Image for illustration purposes only

IMPORTANT SAFETY INSTRUCTIONS

- It is hazardous for anyone other than a competent person to carry out any service or repair operation that involves the removal of a cover which gives protection against exposure to electrical parts.
- If the supply cord is damaged, it must be replaced by the manufacturer, its service agent or similarly qualified persons in order to avoid a hazard. Do not use with damaged cord or plug. Do not run the vacuum cleaner over any cables, or its own power cable. As this will result in damaging the cable.
- This product is intended for household use only. Do not use outdoors.
- This appliance can be used by children aged from 8 years and above and persons with reduced physical, sensory or mental capabilities or lack of experience and knowledge if they have been given supervision or instruction concerning use of the appliance in a safe way and understand the hazards involved. Children should not play with the appliance. Cleaning and user maintenance should not be made by children without supervision.
- Do not direct at people, animals, electrical outlets, or equipment containing electrical components.
- Do not use this appliance to pick up water or any other liquids, combustible substances or hot/burning objects.
- Unplug from outlet when not in use, and before putting on and taking off parts, and before cleaning. Do not leave unattended whilst plugged in.

IMPORTANT SAFETY INSTRUCTIONS

- Do not use appliance if it has been dropped, damaged, left outdoors or dropped into water. Do not operate this appliance for anything other than its intended use.
- Keep the appliance and adapter away from water; do not allow it to get wet.
- If unit is wet, do not plug unit into wall socket or turn unit on. Do not immerse in water or other liquids for cleaning. Do not handle the appliance with wet hands.
- Do not pull or carry by cord, use cord as a handle, close door on cord, pull cord around sharp corners or edges, or expose cord to heated surfaces.
- The use of accessory attachments not recommended by the manufacturer may cause fire, electric shock or injury. Only use the accessories supplied by the manufacturer.
- Only use the appliance when fully assembled.
- Never place your fingers or other objects into any part of the appliance. Be aware that loose clothing or hair may become trapped in the cleaner if improperly used.
- Caution: Exhaust air discharged from the sides of the appliance may extinguish a gas fire, pilot light, or disturb ashes in an open fire. Always avoid directing the appliance toward naked flames. Before use, ensure that all of the air vents are clear and there is no restriction of air flow.



OPERATION

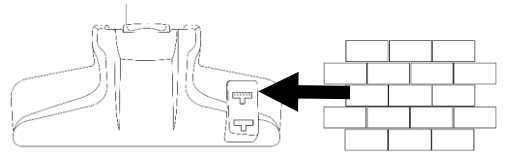
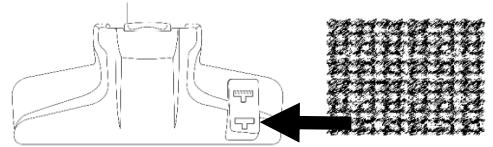
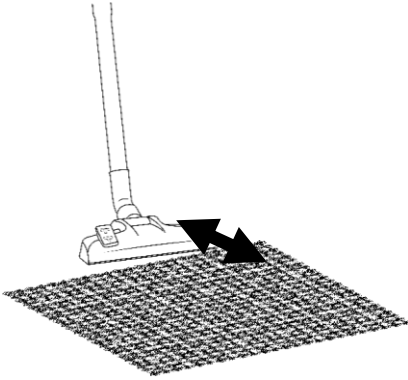

CARRYING THE APPLIANCE

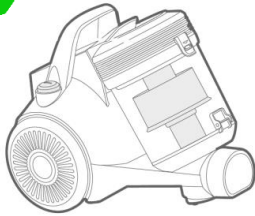

CAUTION
Take care
using as a carry
handle

TOOL ATTACHMENTS

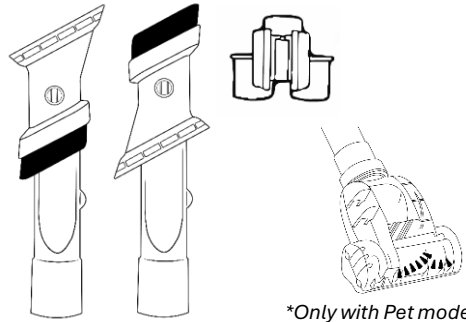

**Only with Pet models*

TOOL ATTACHMENTS

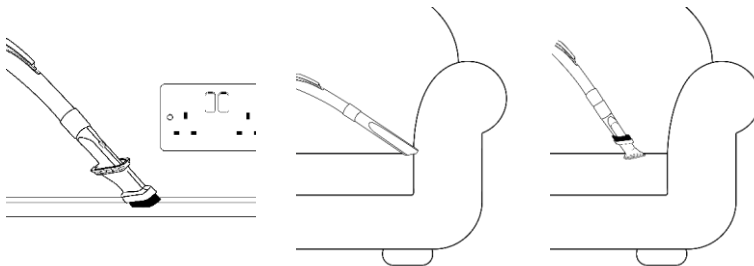

**Do not use on
animals*



EMPTYING THE DUST CONTAINER

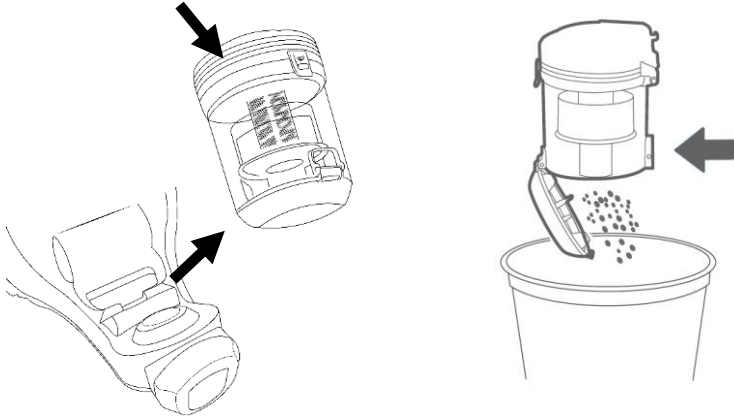

SURFACE USAGE

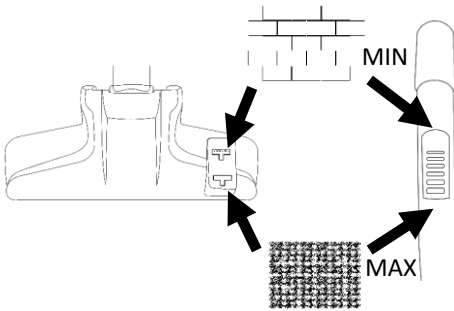

CORD REWIND

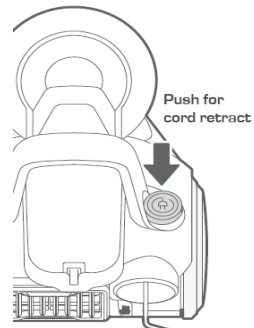

CHECKING FOR BLOCKAGES

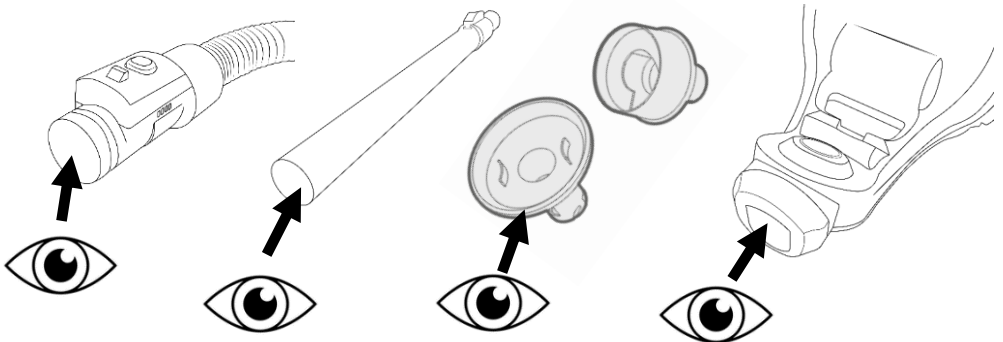

CLEANING THE VACUUM

1



2



3



4



5

24
HRS



6

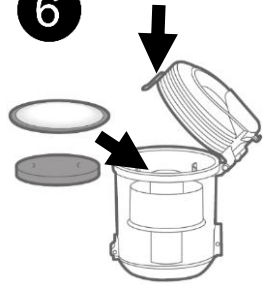

CLEANING THE EXHAUST FILTER

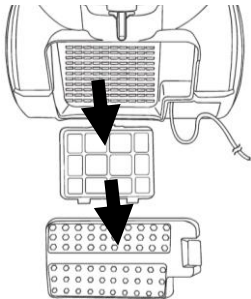

24
HRS

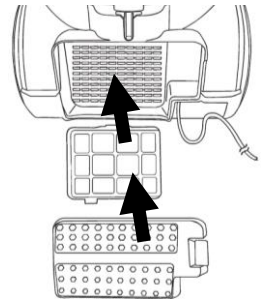
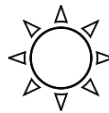

PROBLEM SOLVING

The vacuum cleaner doesn't switch on	<ul style="list-style-type: none">• Check the vacuum is plugged in• Check the socket is switched on• Check another appliance in the socket• Check for any obvious signs of damage to cord or plug• If recently used, allow to cool for 1 hour then try again
The suction is decreasing and dirt is not adequately being picked up	<ul style="list-style-type: none">• Check if the dust canister is full; if so, empty it• Clean the filters following the instructions in this manual• Check there are no blockages in the hose, and clear any obstructions
Vacuum cleaner is over heating	<ul style="list-style-type: none">• Check the filters are clean• Replace the filters if saturated, damaged or no longer working effectively
Dust is coming out of the vacuum	<ul style="list-style-type: none">• The dust canister has not been fitted correctly. Refit the canister following the instructions in this manual.
The air exhausted from the vacuum smells	<ul style="list-style-type: none">• Clean the filters, hose, and dust container following the instructions in this manual• Replace the filters if saturated, damaged or no longer working effectively
The vacuum cleaner has cut out	<ul style="list-style-type: none">• Allow the vacuum to cool for 1 hour. Clean all filters and dust containers before trying to use again.

IMPORTANT!
WASH FILTERS

Wash the filters with cold water at least once a month

1

MONTH

Energy Consumption

Product information for power consumption and maximum time to reach applicable low power mode

Off Mode	<0.5W
----------	-------

Filter Replacement

Your vacuum cleaner filters will wear with use and cleaning. To ensure optimal performance, we recommend you replace your filters at least every 1 year depending on usage and maintenance.

Filter code:	RHFILTCV3101-3601
--------------	-------------------

NOTES

NOTES



Russell Hobbs

Made by Product Care Trading Limited under license from Spectrum Brands (UK) Limited. Product Care Trading Ltd, Unit 1, Green Bank Business Park, Swan Lane, Hindley Green, Wigan, WN2 4AY, United Kingdom

Product Care (Ireland) Ltd, Unit 3D North Point House, North Point Business Park, New Mallow Road, Cork, T23 AT2P, Ireland. Russell Hobbs is the registered trademark of Spectrum Brands (UK) Ltd.

**UK
CA**



The 'wheellie bin' symbol is known as the 'Crossed-out wheellie bin Symbol'. When this symbol is marked on a product/batteries, it means that the product/batteries should not be disposed of with your general household waste. Only discard electrical/electronic/battery items in separate collection schemes, which cater for the recovery and recycling of materials contained within. Your co-operation is vital to ensure the success of these schemes and for the protection of the environment. For your nearest disposal facility, visit www.recycle-more.co.uk or ask in store for details.

SEDEX – Connecting businesses and their global suppliers to share ethical data and enabling improvement in ethical performance. Visit www.sedex.org.uk for further information.

We reserve the right, due to possible changes to design, to alter the instruction manual without prior notice.

Revision 5.1