









ITEM: 1408-GB-A	① SEAT 	② GAS LIFT 	③ COLUMN 	④ BASE 	⑤ Screw  M8x30 3Pcs	⑥ Screw  M6x15 4Pcs	⑦ Wrench  Φ4x1Pcs	⑧ Wrench  Φ5x1Pcs	
---------------------------	---	---	---	---	---	---	---	---	--

STEP A

- Align the gas lift (2) onto the base (4) as pictured.
- Use allen wrench (8) to lock the 3 screws (5).

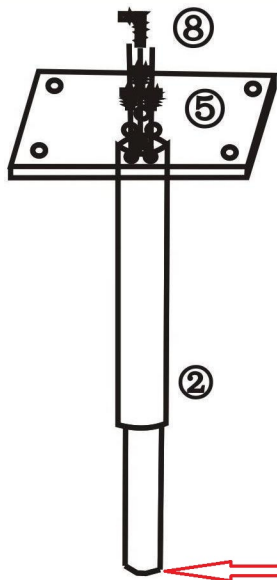

Remove the black cap on the top of the gas lift.

STEP B

- Align the column (3) onto middle of the frame as pictured.
- Use allen wrench (7) to lock the 4 screws (6).

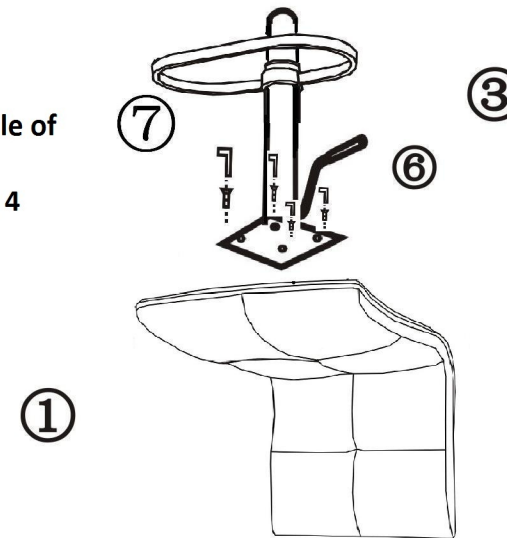

STEP C

- Place the assembled seat onto the base and make sure it is placed vertically.



STEP D

