

ASSEMBLY INSTRUCTIONS

118-911 SOFA TABLE

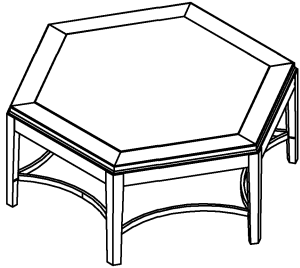

118-911





IMPORTANT NOTES :

- . Place all parts on the clean and smooth surface such as a rug or carpet to prevent the parts from being scratched.
- . Check to be sure that you have all parts and hardware.
- . Remove all wrapping materials, including staples and packing straps before you start to assemble.
- . Do not tighten all screws and bolts until completely assembled.
- . Keep all hardware out of the reach of children.

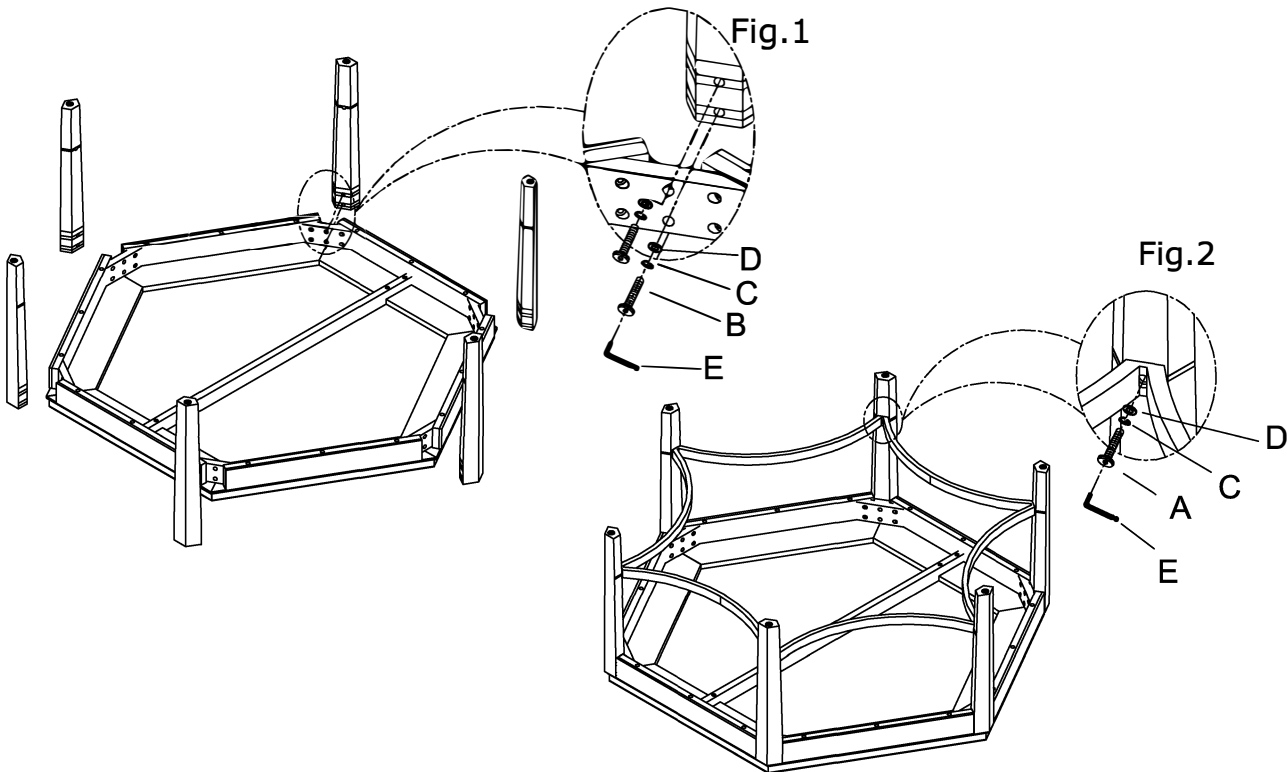
Caution: Do not over tighten any bolts during assembly.

1. Turn the table upside down on a clean soft surface.
2. Attach 6 legs to the table top using the Bolts (B), Spring washers (C), Flat washers (D) and tighten with the Wrench (E) (as show Fig.1).
3. Attach the metal frame to the legs using the Bolts (A), Spring washers (C), Flat washers (D) and tighten with the Wrench (E) (as shown Fig.2).



HARDWARE LIST			
ITEM	DRAWING	DESCRIPTION	Q' TY
A		Bolt (Ø1/4"*3/4")	6PCS
B		Bolt (Ø1/4"*1-1/2")	12PCS
C		Spring Washer (Ø1/4")	18PCS
D		Flat Washer (Ø1/4"*Ø16mm)	18PCS
E		Allen Wrench(4mm)	1PC

MADE IN VIETNAM