

# *Instruction manual*

## **Round Dining table 100cm**

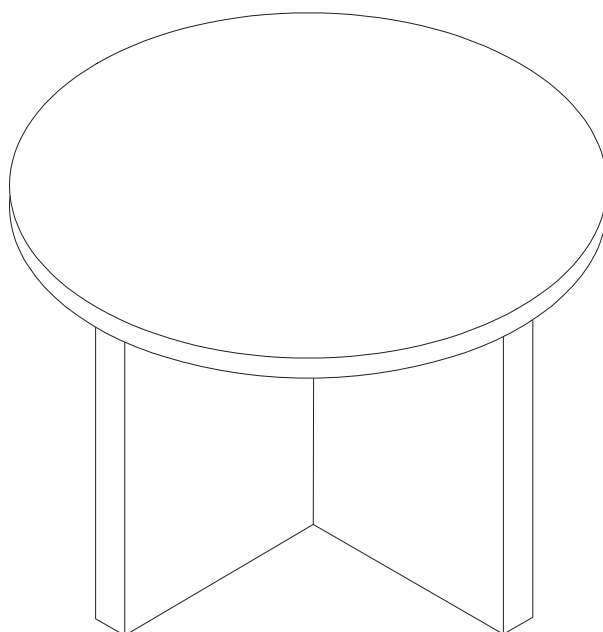













## SAFETY AND CARE ADVICE

**PLEASE READ THESE INSTRUCTIONS CAREFULLY AND KEEP FOR FUTURE**

- Check you have all the components and tools listed on pages 1.
- Remove all fittings from the plastic bags and separate them into their groups.
- Keep children and animals away from the work area, small parts could choke if swallowed.
- Make sure you have enough space to layout the parts before starting.
- Do not stand or put weight on the product, this could cause damage.
- Assemble on a soft level surface to avoid damaging the unit or your floor (use opened out unit carton).
- We do not recommend the use of power drill/drivers for inserting screws, as this could damage the unit. Only use hand screwdrivers.



## COMPONENTS

A x1PC 	B x1PC 	C x1PC 	D x4PC 
E x4PC 	F x4PC 	G x16PC 	H x4PC 
I x8PC 	J x1PC 	K x2PC 	

# ASSEMBLY INSTRUCTIONS

---

step 1

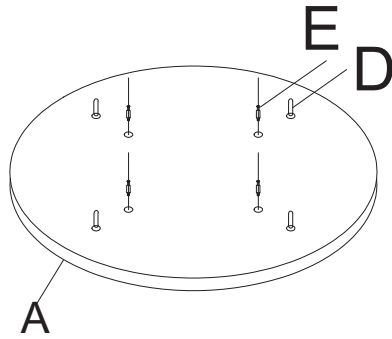

---

step 2

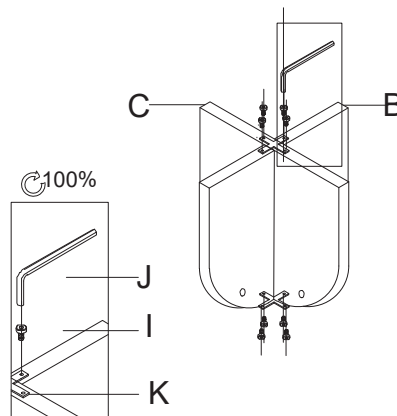

# ASSEMBLY INSTRUCTIONS

---

step 3

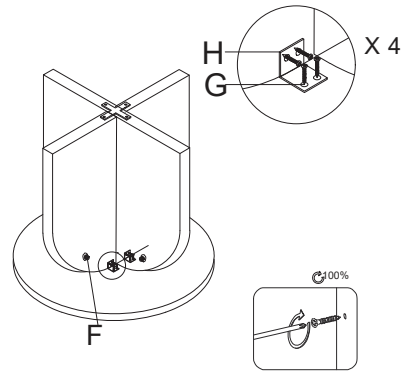

---

step 4

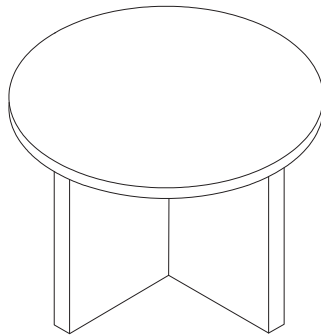

***Congratulations!***  
***Now you have finished assembling the product.***

---