

ASSEMBLY INSTRUCTIONS

Disclaimer:

Thank you for your purchase. Please read carefully and keep these instructions, as you may need them later. We suggest installation by a **licensed electrician**.

Beware of potential electrical shock! Before installing the fixture or removing any other light already present, please turn off the main power at the circuit breaker.

If your product contains glass items, please handle with care, as glass is fragile and can lead to injuries if handled incorrectly.

Please keep in mind that the warnings and instructions present in this document are not meant to cover and prevent all possibilities and situations that could lead to injury or damage. It is the responsibility of the end-user to exercise caution and common sense when handling and installing the product.

All electrical connections must be made by qualified personnel in accordance with the National Electrical Code.

Please refer to the table below for electrical connections:

Fixture wire markings:

"L" Live wire (Black or Brown)

"N" Neutral wire (White or Blue)

"⊕" Ground wire (Bare copper or Green)

AC power equivalent:

"L" Live wire (Black)

"N" Neutral wire (White)



"⊕" Ground wire (Bare copper or Green)

Note: Select the type of installation you require before assembly and installation:

This luminaire can be installed as a Pendant or Close to Ceiling.

Refer to the corresponding instructions and diagram for the different installation methods.

For installation, please refer to the written instructions, or follow [the link for the video instructions.](#)

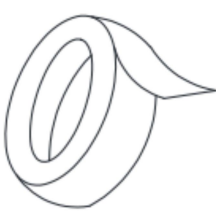
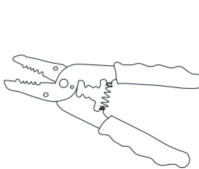
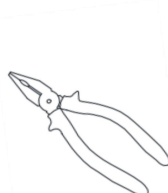
Tools Required: (not included)				
				
Step Ladder	Phillips Head, Flat Blade Screwdrivers	Electrical tape	Wire Cutter/Stripper	Plier

Pendant lamp Installation instructions:

Step 4. Use the two screws (B) secure mounting bracket (A) to the junction box.

Step 5. Use the screw nut (D) secure canopy (C) to the mounting bracket (A).

Step 2. Adjustable length of hanging chain. Pass the wire and ground wire through the hanging chain, canopy (C), hanger (P), and mounting bracket (A) to the junction box. Hang both ends of the chain onto the two hangers (S/P)

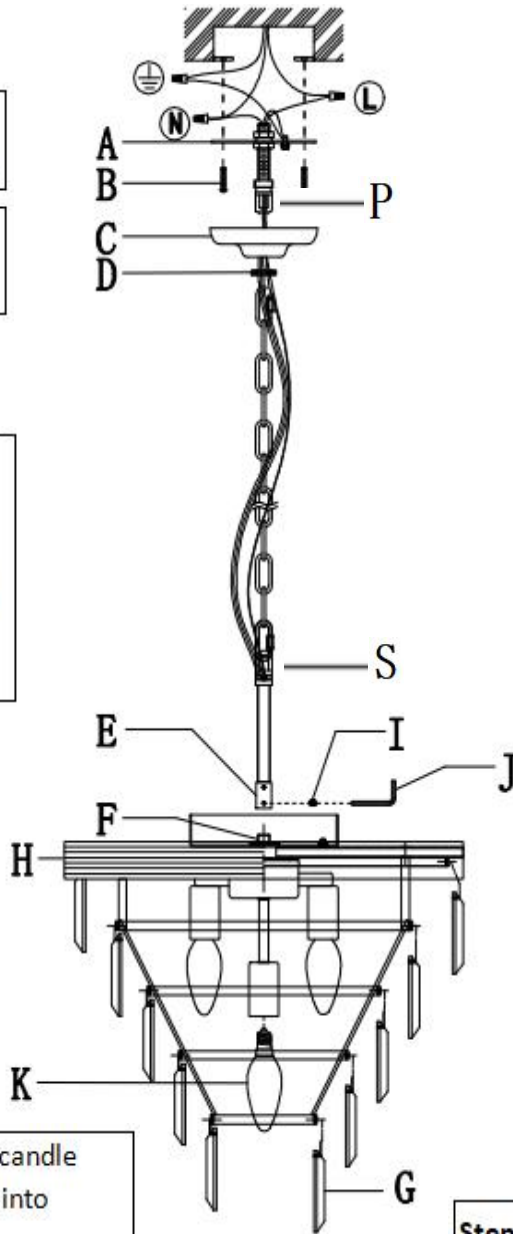

Step 6. Install the E12 LED candle bulbs 4pcs (K not included) into lampholder.

Step 7. Hang the crystals (G) on the holes of the lamp body (H) from down side to upside.

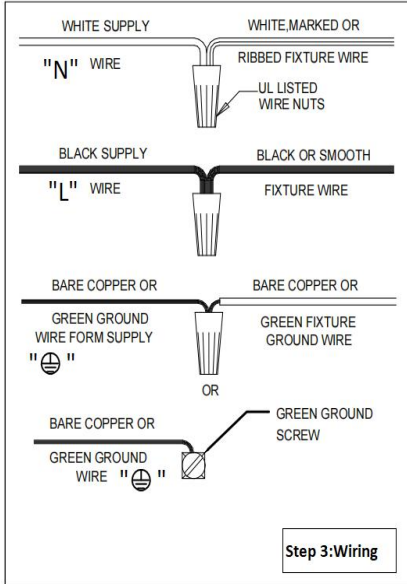

Step 1: Screw the straight tube (E) into the coupling nut (F) and use a wrench (J) to tighten the screw (I).

Parts Included:

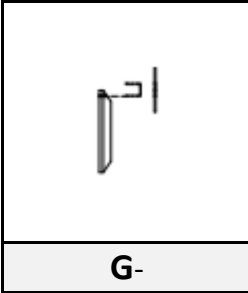

Close to Ceiling Installation instructions:

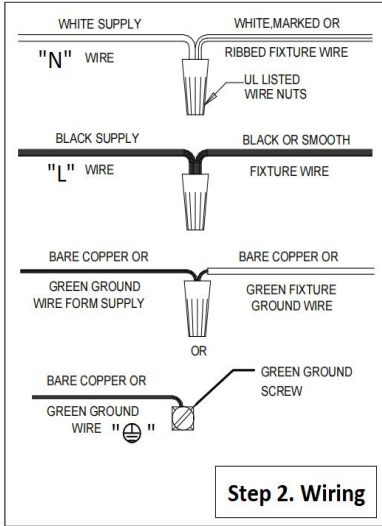

Step 1. Use the two screws (B) to secure mounting bracket (A) to the junction box.

Step 3. Use the screw nut (E) to secure canopy (C) to the mounting bracket (A).

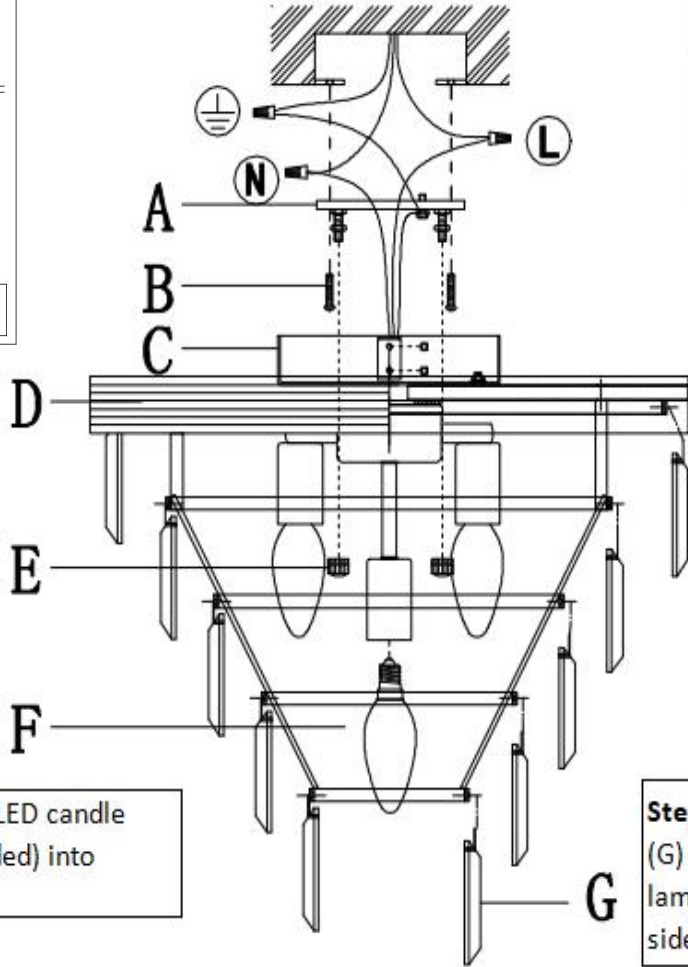

Step 4. Install the E12 LED candle bulbs (F not included) into lampholder.

Step 5. Hang the crystals (G) on the holes of the lamp body (H) from down side to upside.

Parts Included:

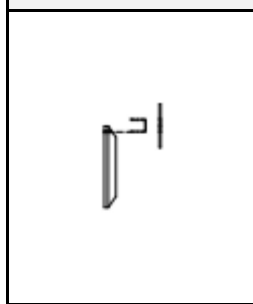

G-
152PCS+3Spare

Warranty

1-YEAR LIMITED WARRANTY

The manufacturer warrants this product to be free from defects in materials and workmanship for one (1) year from the date of purchase. This warranty is valid only for the original consumer purchaser and covers the product under normal use and conditions. If the product is found to be defective, the manufacturer's sole obligation and your exclusive remedy is to repair or replace the product at the manufacturer's discretion, provided it has not been damaged by misuse, abuse, accident, alteration, modification, negligence, or mishandling.

This warranty does not cover labor or any costs associated with the removal or installation of defective, repaired, or replaced products. The warranty excludes damages resulting from misuse, mishandling, misapplication, negligence (including improper maintenance), accidents, incorrect installation, modifications (including unauthorized parts or accessories), or adjustments and repairs.