









Assembly Instructions for

160-632S SONOMA SIDE CHAIR

Thank you for purchasing this quality product. Be sure to check all packing material carefully for small parts, which may have come loose inside the carton during shipment. Identify and count all parts and compare with the HARDWARE LIST below .

1. We recommend that you should assemble this product with the assistance of another person; this will make assembly easier, and will help to eliminate damage to the product or injury to persons during assembly.
2. Please do not over tighten screws or bolts until the assembly is completed.
3. Please put all parts on a non-abrasive floor before assembly, and follow the assembly steps to assemble your newly purchased product correctly and efficiently.

NO.	COMPONENT LIST		Q'TY
A	Chair back		1
B	Cushion Seat w/ Seat Box		1
C	Front Legs		2

NO.	HARDWARE LIST			Q'TY
1		Allen Bolts	5/16"*40mm	2
2		Allen Bolts	5/16"*64mm	4
3		Allen Bolts	5/16"*76mm	4
4		Lock Washer	8mm	10
5		Spring Washer	8*19*2mm	10
6		Allen Key	4*30*80mm	1

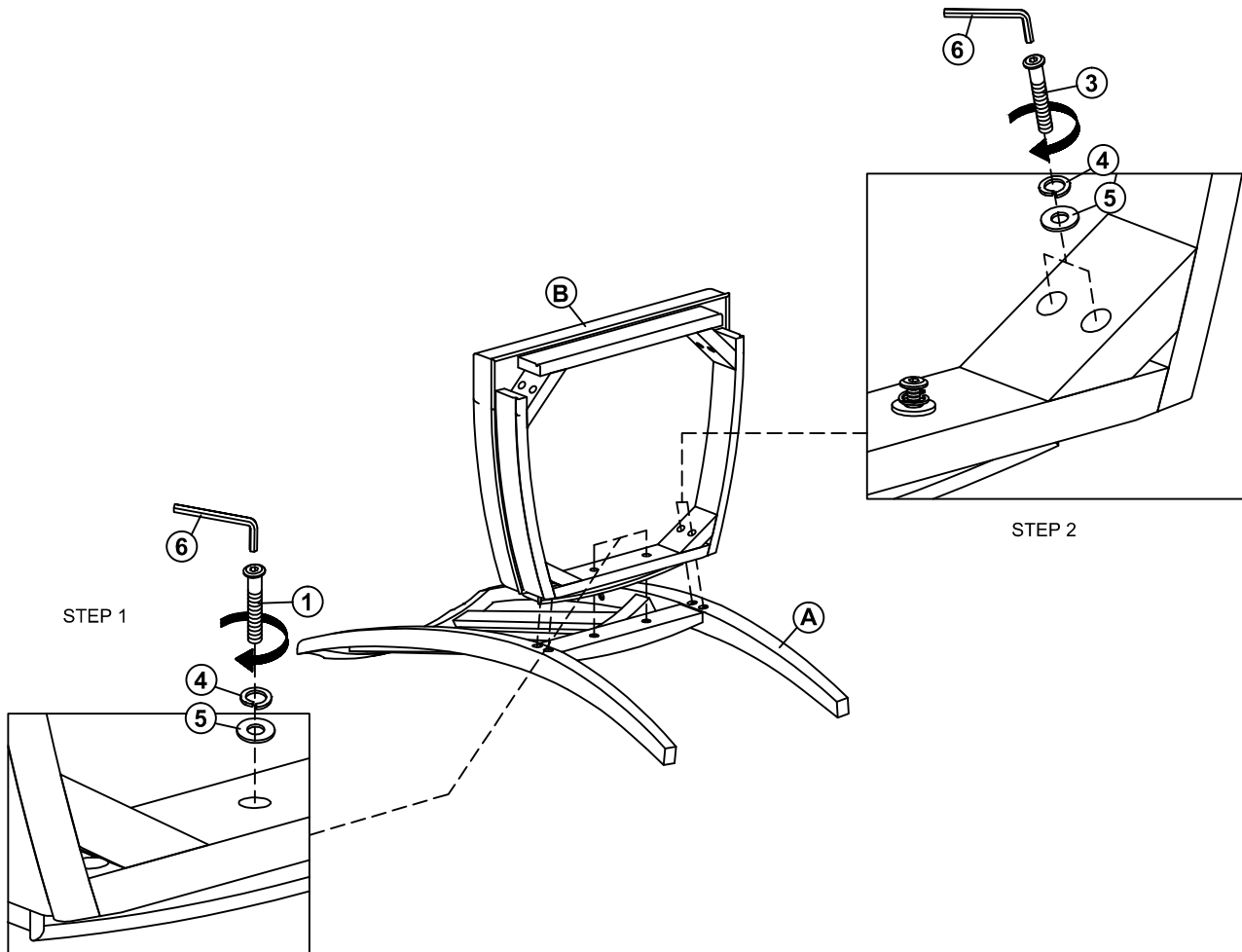

MADE IN VIETNAM

