

ASSEMBLY & INSTRUCTION MANUAL

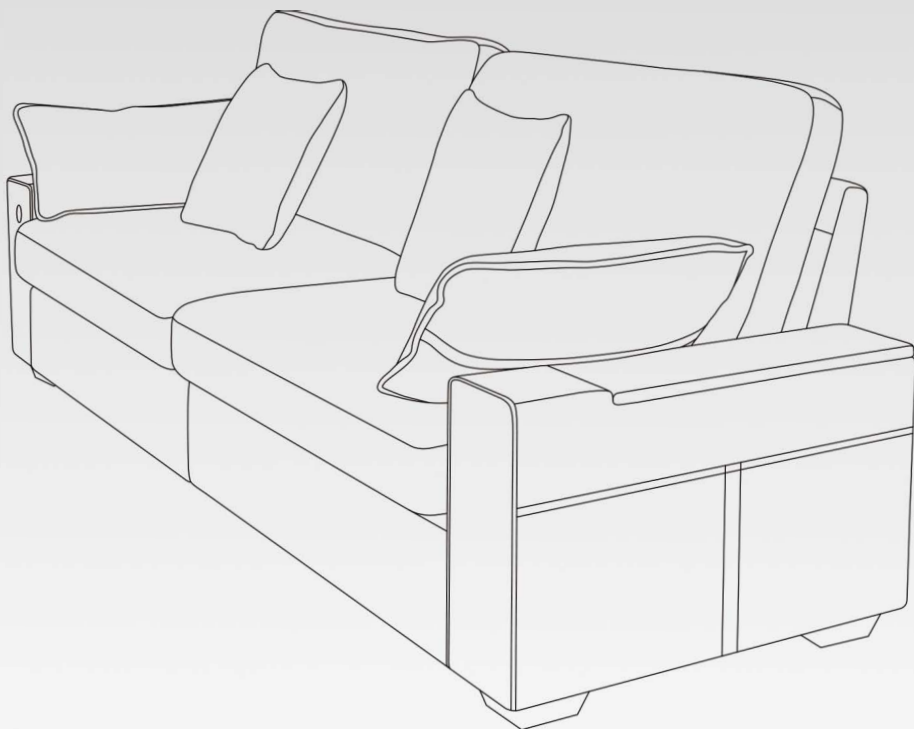

SOFA ■

CONTENTS

01

ENGLISH PRODUCT MANUAL

1. WARNING	Pg 01
2. SAFETY INFORMATION	Pg 01
3. ASSEMBLY PARTS AND TOOL	Pg 02
4. ASSEMBLY INSTRUCTIONS	Pg 03
5. LIMITED WARRANTY	Pg 15

02

MANUAL DE PRODUCTO EN ESPAÑOL

1. ADVERTENCIA	Pg 17
2. INFORMACIÓN DE SEGURIDAD	Pg 17
3. PIEZAS Y HERRAMIENTA DE MONTAJE	Pg 18
4. INSTRUCCIONES DE MONTAJE	Pg 19
5. GARANTÍA LIMITADA	Pg 31

WARNING

Please read the instructions carefully and follow the assembly steps.

To ensure proper assembly, please follow all steps and use all parts provided. Not following this warning may result in serious injury to you or others.

To prevent misalignments, keep the screws loose and do not tighten them until they are all in their correct positions.







Avoid overtightening or forcing the screws, as this could cause them to break, strip, or damage the threads of the holes.

Using the wrong size of screws for a particular part could cause damage to the screw or the part.

Please lubricate all moving parts regularly and tighten all bolts and screws every 6 months, or as needed.







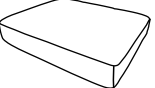
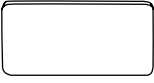

SAFETY INFORMATION

WEIGHT CAPACITY FOR PRODUCT: 720LBS (≈326KG)

 <p>Sit in the center of the chair with your back against the backrest</p>	 <p>Do not sit at the front edge of the chair</p>  <p>Do not push the chair around when a person is sitting in it</p>	 <p>Do not stand on the chair</p>  <p>Do not push down on the backrest when a person is reclined</p>	 <p>Do not use the chair with more than three people</p>  <p>Do not place all your weight on the backrest only</p>
---	--	---	---

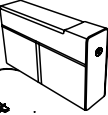
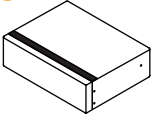
ASSEMBLY PARTS AND TOOL

PLEASE MAKE SURE ALL THE PARTS ARE INCLUDED.

<p>1</p>  <p>Seat Cushion Sponge *2</p>	<p>2</p>  <p>Seat Cushion Cover *2</p>	<p>3</p>  <p>Back Cushion Sponge *2</p>	<p>4</p>  <p>Back Cushion Cover *2</p>	<p>5</p>  <p>Throw Pillow Insert *2</p>
<p>6</p>  <p>Pillow Case *2</p>	<p>7</p>  <p>Side Throw Pillow *2</p>	<p>8</p>  <p>Backrest Brackets *2</p>	<p>9</p>  <p>Left-side Bottom Bracket *1</p>	<p>10</p>  <p>Left-side Armrest *1</p>
<p>11</p>  <p>Right-side Bottom Bracket *1</p>	<p>12</p>  <p>Right-side Armrest *1</p>	<p>13</p>  <p>Base Plates *2</p>	<p>14</p>  <p>Feet *4</p>	
<p>A</p>  <p>Stud Bolts *16</p>	<p>B</p>  <p>Short Bolts *4</p>	<p>C</p>  <p>Long Bolt *1</p>	<p>D</p>  <p>Hex Nut *17</p>	<p>E</p>  <p>Flat Washer *18</p>
<p>F</p>  <p>Hex Wrench *1</p>	<p>G</p>  <p>Wrench *1</p>			

BEFORE YOU GET STARTED, A FEW POINTERS:

 Having a friend to help makes assembly extra-easy.

 Please use the included wrench instead of an ELECTRIC HAND DRILL in case of damage to the product.

ASSEMBLY INSTRUCTIONS

Note: Before installation, please remove each component from the sofa.

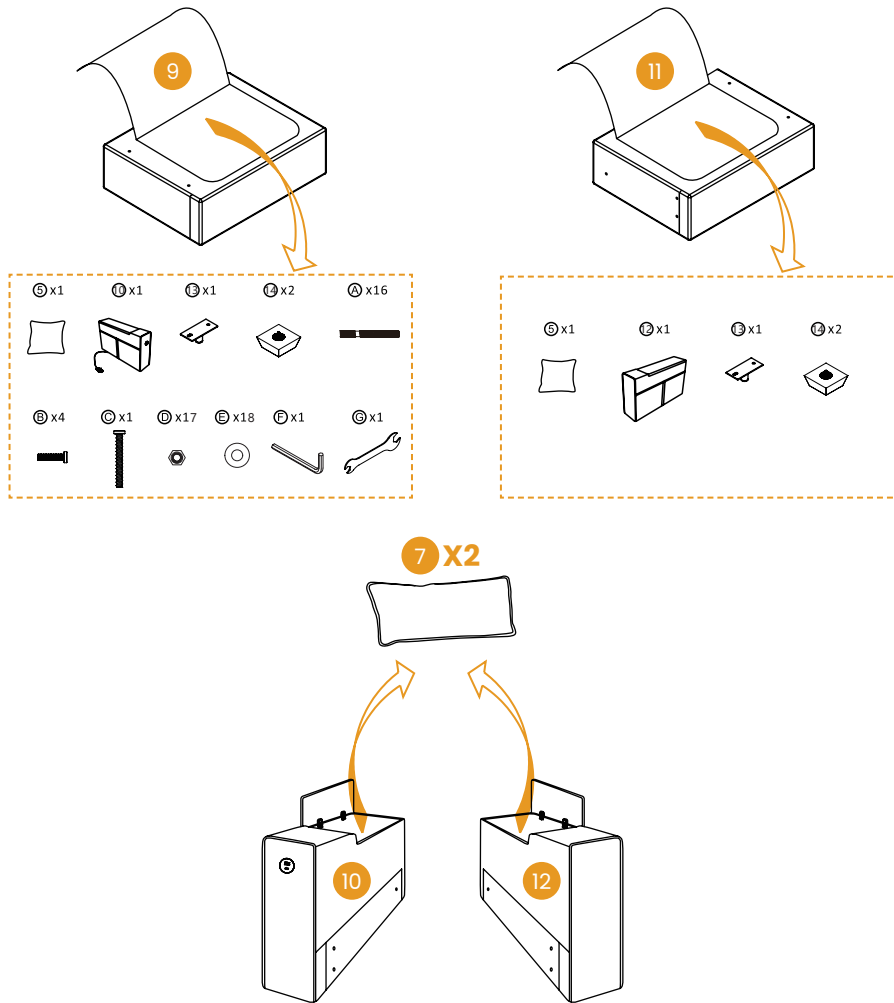

ASSEMBLY INSTRUCTIONS

STEP 1 Tighten the shorter end of the Stud Bolt (A) onto the Backrest Brackets (8) of the sofa. Note that there are two Backrest Brackets (8) in total, and four Stud Bolts (A) need to be tightened onto each Backrest Bracket (8).

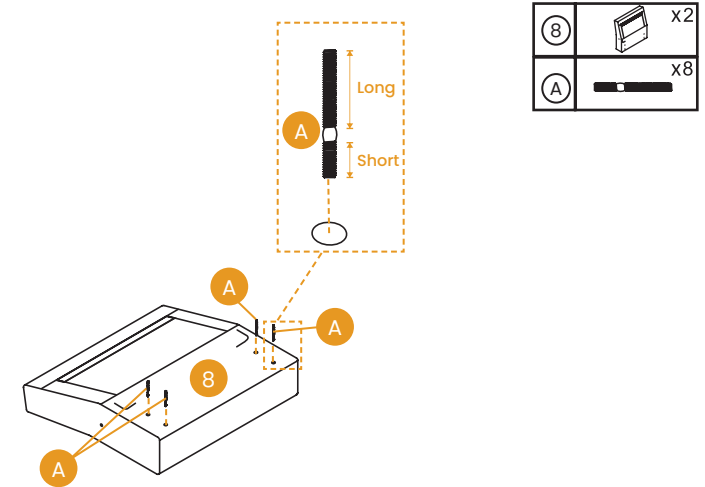



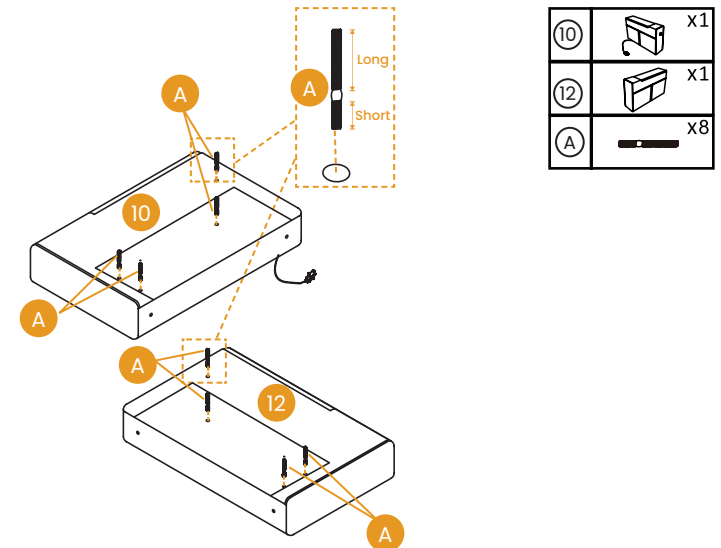

STEP 2 Tighten the shorter end of the Stud Bolt (A) onto the Armrests (10&12) of the sofa. Note that each Armrest needs four Stud Bolts (A).



ASSEMBLY INSTRUCTIONS

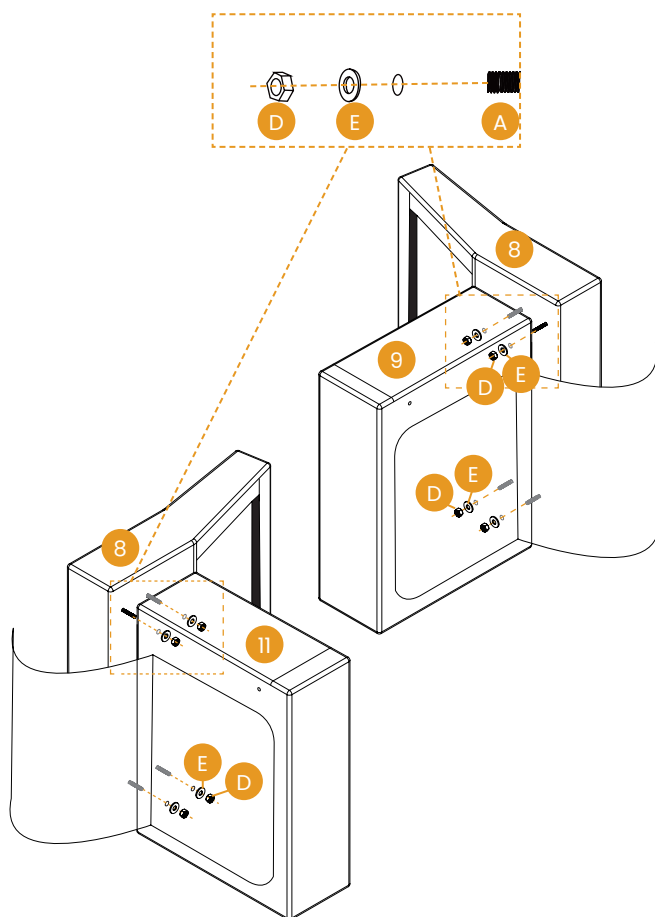

STEP 3 Open the sofa base cover at the bottom of the Backrest Brackets (8), then connect Bottom Brackets (9&11) and Backrest Brackets (8) together. Each Stud Bolt (A) needs to be paired with one Hex Nut (D) and one Flat Washer (E) for use, using the Wrench (G).

9		x1
11		x1
D		x8
E		x8



ASSEMBLY INSTRUCTIONS

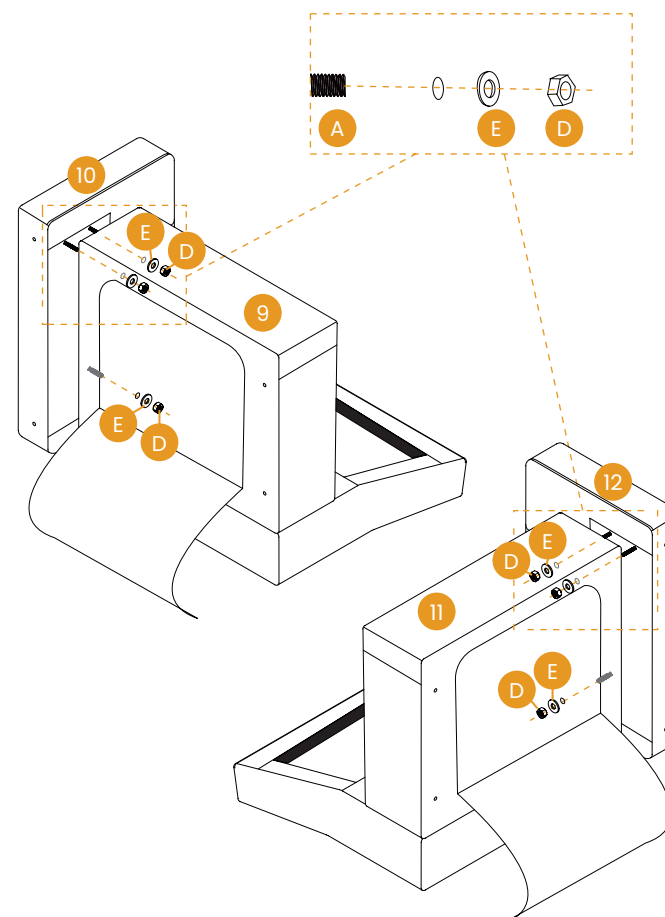

STEP 4 Open the sofa base cover at the bottom of the two Backrest Brackets (8), then connect Left-side Bottom Bracket (9) and Left-side Armrest (10) together, connect Right-side Bottom Bracket (11) and Right-side Armrest (12) together. Each Stud Bolt (A) needs to be paired with one Hex Nut (D) and one Flat Washer (E) for use, using the Wrench (G).

D		x6
E		x6





ASSEMBLY INSTRUCTIONS

STEP 5 Open the Backrest Bracket cover at the left side, then use one Hex Nut (D) and one Flat Washer (E) to fix it, using the Wrench (G).

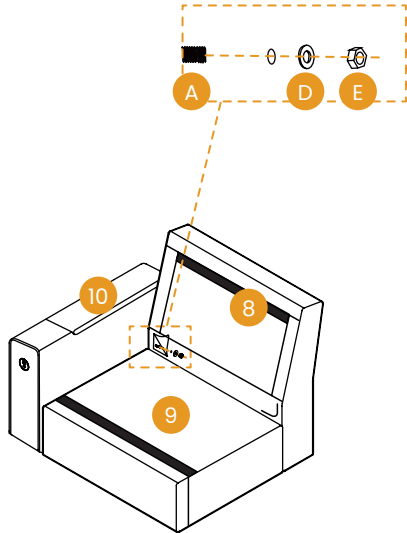
ⓓ		x1
ⓔ		x1



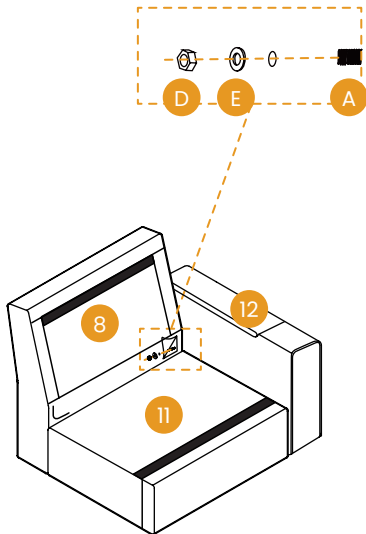

STEP 6 Open the Backrest Bracket cover at the right side, then use one Hex Nut (D) and one Flat Washer (E) to fix it, using the Wrench (G).

ⓓ		x1
ⓔ		x1



ASSEMBLY INSTRUCTIONS

STEP 7 Open the Backrest Bracket cover in the neutral position, then insert one Stud Bolt (A) from the left side to the right side with one Flat Washer (E), finally use one Hex Nut (D) and one Flat Washer (E) to fix it on the other side, using the Wrench (G).

Ⓒ		x1
ⓓ		x1
ⓔ		x2

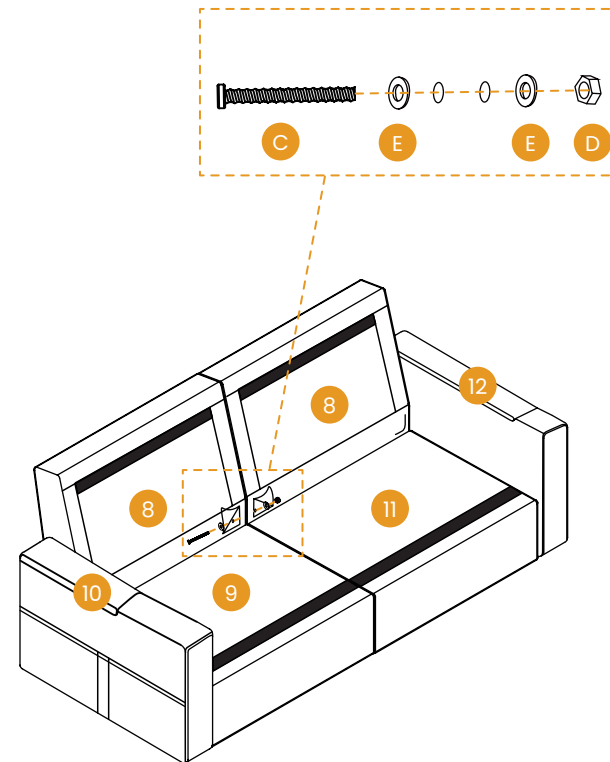

ASSEMBLY INSTRUCTIONS

STEP 8 Fix the Base Plates (13) to the bottom of the sofa according to the position shown in the picture with four Short Bolts (B), using the Hex Wrench (F).

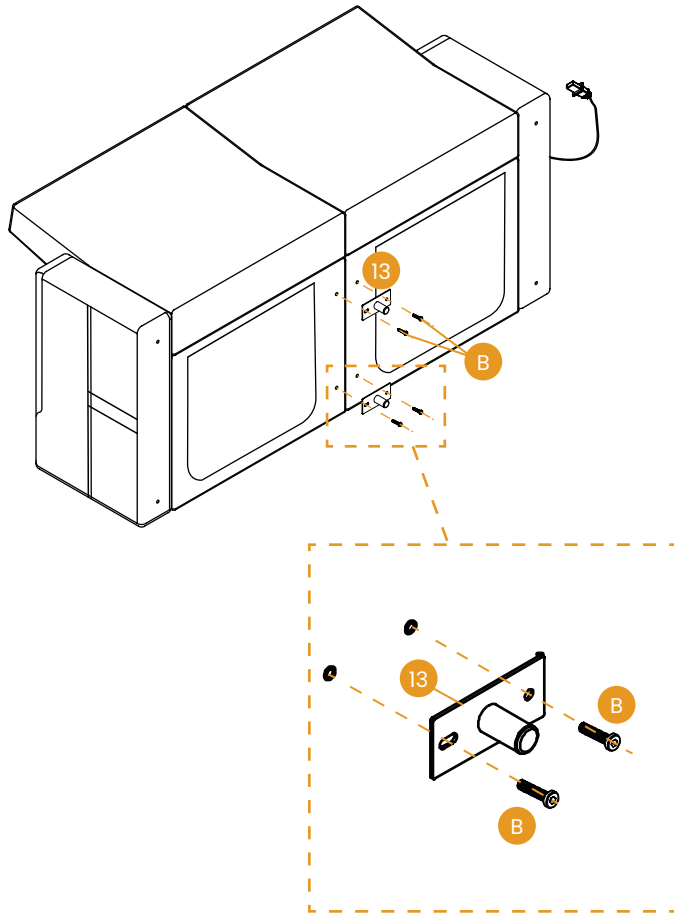
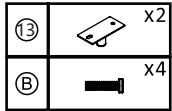

ASSEMBLY INSTRUCTIONS

STEP 9 Install the four Feet (14) to the bottom of the sofa.

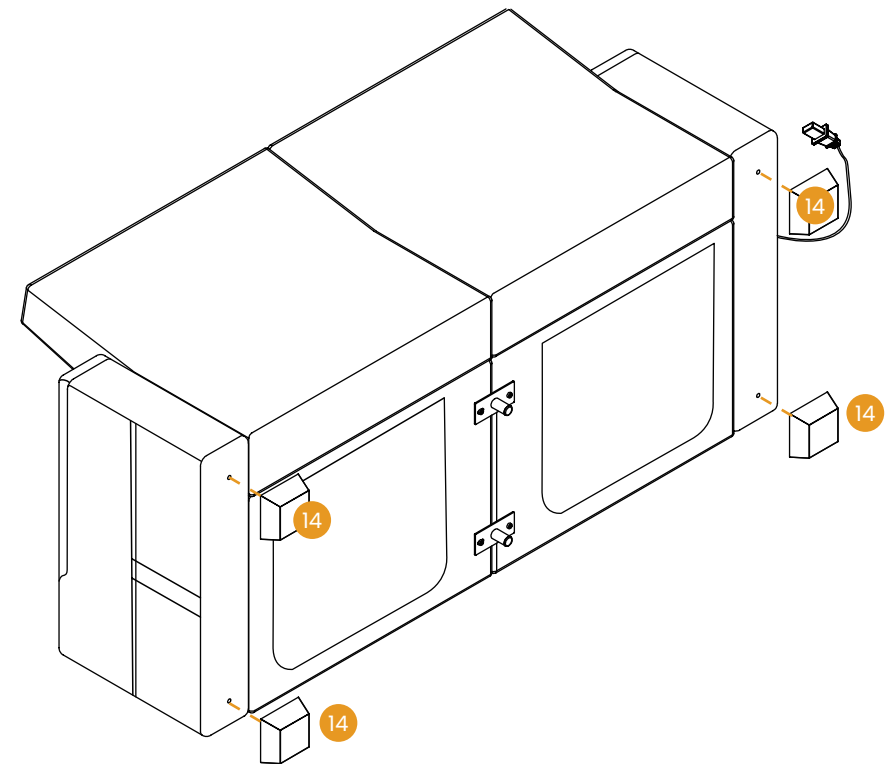
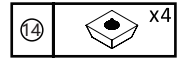

ASSEMBLY INSTRUCTIONS

STEP 10 Open the bag containing the Seat Cushion Sponge (1) and make it fluffy, then put on the Pillow Case (6). Place the two Seat Cushions on the Bottom Brackets (9&11).

Note: There is a forward indication sign on the seat cushion.

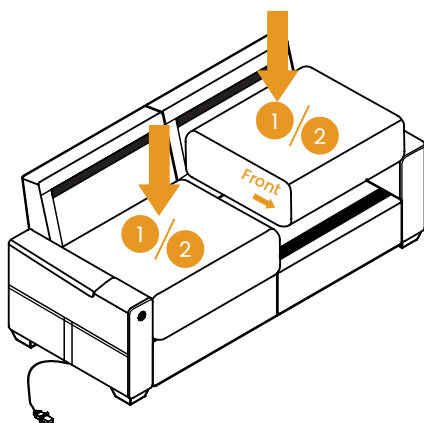
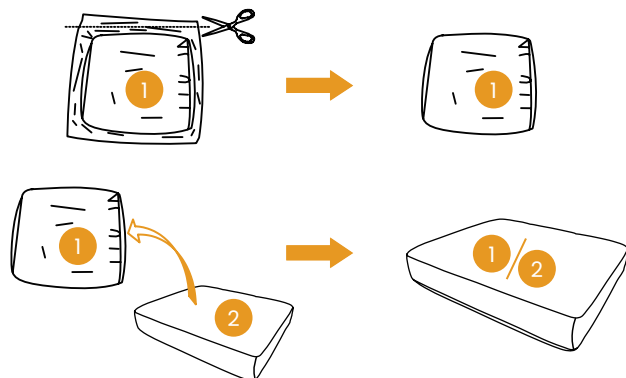
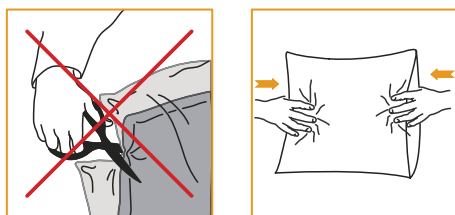
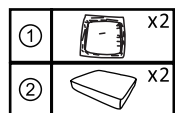

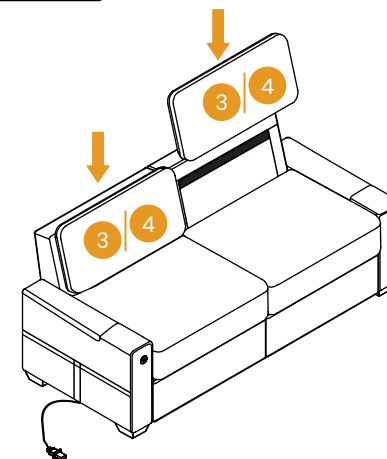
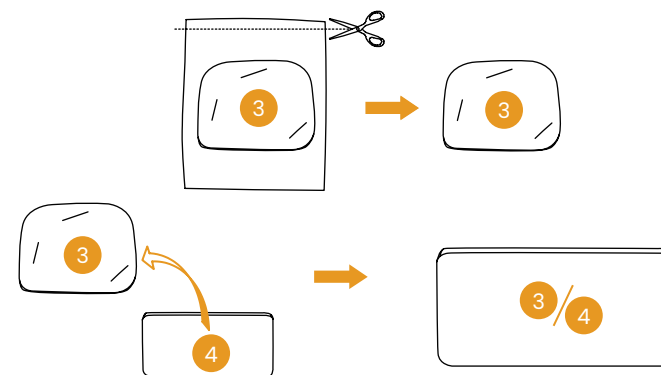
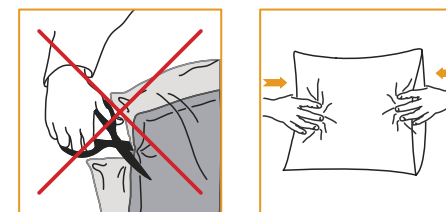

ASSEMBLY INSTRUCTIONS

STEP 11 Open the bag containing the Back Cushion Sponge (3) and make it fluffy, then put on the Back Cushion Cover (4). Place the two Back Cushions on the Seat Cushions.



ASSEMBLY INSTRUCTIONS

STEP 12 Put the Throw Pillow Insert (5) into the Pillow Case (6), then place the Pillow and Side Throw Pillow (7) in the corresponding position on the sofa.

⑤		x2
⑥		x2
⑦		x2

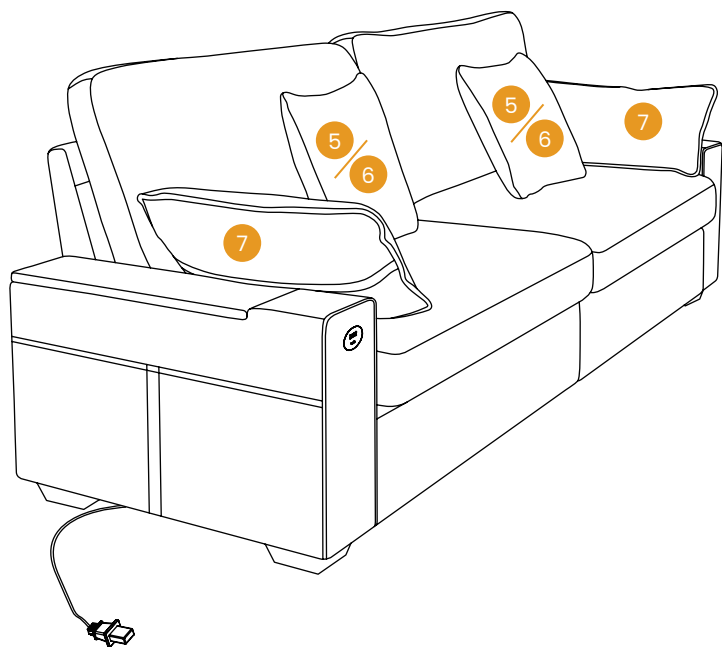
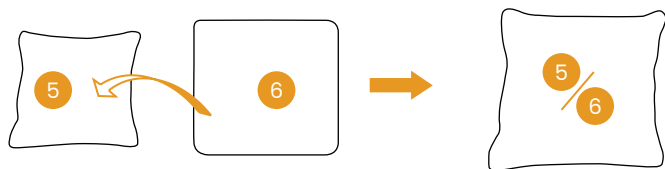

ASSEMBLY INSTRUCTIONS

STEP 13 There is a plastic cover on the plug. Remove the cover and then plug it in to use.

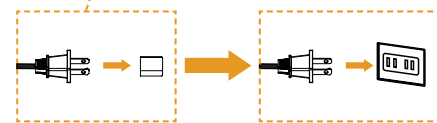
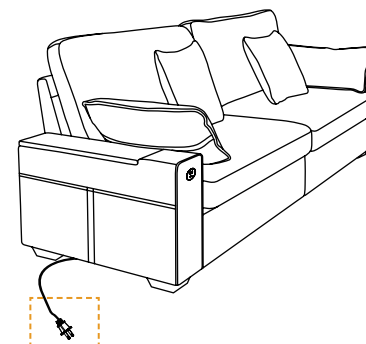

STEP 14 Now, your sofa is successfully installed.

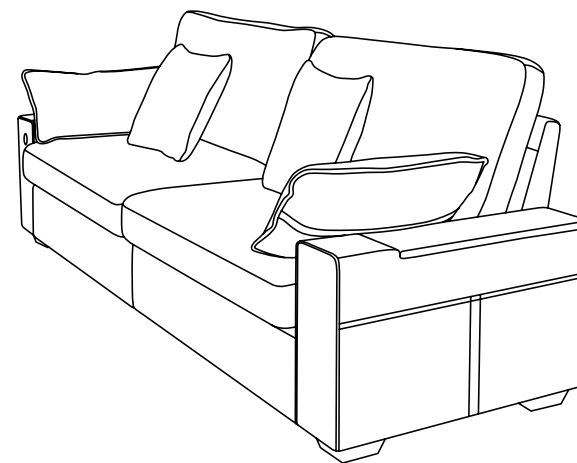

LIMITED WARRANTY

We promise to repair or replace any product that is found to be defective in material or workmanship within one year from the date of original purchase, as long as you, the original purchaser, still own it. This is your sole and exclusive remedy under this warranty, subject to the provisions outlined below.

EXCLUSIONS

This warranty does not apply to, and no other warranty applies to:

- Normal wear and tear, which is to be expected over the course of ownership.
- Misuse, abuse, or excessive use of the product.
- Modifications or attachments to the product that are not approved.
- Products that were not installed, used, or maintained in accordance with the product instructions and warnings.
- Products used for rental purposes or unauthorized retail activities.

Product Usage: Normal use for the product is defined as equivalent to a single shift, forty-hour (40) workweek. If the product is used in a manner exceeding this, the applicable warranty period will be proportionately reduced.

RETURN POLICY

We offer a 30-day return policy, meaning that all products purchased may be returned to us within that timeframe. You must contact us via email or customer service phone number within 30 days of receiving the product(s), and they must be returned to us without any undue delays.

CONDITIONS:

- Returned products must be in the same condition as received and returned in their original packaging.
- If the product is not faulty (i.e., if you change your mind or are unhappy with the product for another reason), you are responsible for the cost of return shipping. You must ensure the package arrives safely to us, so we recommend using a courier service that offers tracking.

LIMITED WARRANTY

- If the product is faulty when received, please contact us, and we will assist you with the return, covering the shipping costs in this case.
- We reserve the right to offer partial refunds for returned products that are not in unused condition, are damaged, or have missing parts not due to our error.

HOW RETURNS WORK

To request a return, please attach a copy of your invoice as proof of purchase, along with the reason for the return.

We will provide the return address for the product as soon as possible. Once the returned product is received and inspected, we will provide a specific resolution.

If the return is approved, the refund amount will be automatically credited to your original payment method.

MAINTENANCE INSTRUCTIONS



Dust and clean up spills immediately using a clean, non-colored, lint-free cloth.



Use a mild soap solution and a damp cloth to remove stains.



Do not place hot items directly on the furniture surface without using a protective barrier.



For indoor use only. Do not place the furniture outside.



Do not place furniture in direct sunlight.



Do not write on the furniture surface without a padded barrier to protect it.



Do not clean furniture with harsh cleaners or polishes.



Do not place furniture near heating or cooling vents (keep at least 3 feet away)

ADVERTENCIA

Por favor, lea las instrucciones cuidadosamente y siga los pasos de ensamblaje.

Para garantizar un ensamblaje adecuado, siga todos los pasos y utilice todas las piezas proporcionadas. No seguir esta advertencia puede resultar en lesiones graves para usted u otros.

Para evitar desalineaciones, mantenga los tornillos sueltos y no los apriete hasta que estén todos en sus posiciones correctas.

Evite apretar demasiado o forzar los tornillos, ya que esto podría hacer que se rompan, se desgasten o dañen las roscas de los agujeros.

Usar tornillos de un tamaño incorrecto para una pieza particular podría dañar el tornillo o la pieza.

Lubrique todas las partes móviles regularmente y apriete todos los pernos y tornillos cada 6 meses, o según sea necesario.

INFORMACIÓN DE SEGURIDAD

CAPACIDAD DE CARGA DEL PRODUCTO: 720LBS (≈326KG)



Siéntese en el centro de la silla con la espalda apoyada en el respaldo



No se sienta en el borde delantero de la silla



No empuje la silla mientras una persona esté sentada en ella



No se pare sobre la silla



No presione el respaldo cuando una persona esté reclinada











No utilice la silla con más de tres personas.

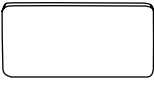

No coloque todo su peso solo sobre el respaldo

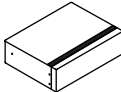
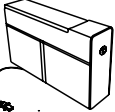
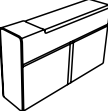
PIEZAS Y HERRAMIENTA DE MONTAJE

POR FAVOR, ASEGÚRESE DE QUE TODAS LAS PIEZAS ESTÉN INCLUIDAS.

- 1  Esponja del cojín del asiento *2
- 2  Funda del cojín del asiento *2
- 3  Esponja del cojín del respaldo *2
- 4  Funda del cojín del respaldo *2
- 5  Inserto del cojín decorativo *2
- 6  Funda del cojín decorativo *2
- 7  Cojín decorativo lateral *2
- 8  Soportes del respaldo *2
- 9  Soporte inferior izquierdo *1
- 10  Reposabrazos izquierdo *1
- 11  Soporte inferior derecho *1
- 12  Reposabrazos derecho *1
- 13  Placas base *2
- 14  Pies *4
- A  Pernos de perno *16
- B  Pernos cortos *4
- C  Perno largo *1
- D  Tuerca hexagonal *17
- E  Arandela plana *18
- F  Llave hexagonal *1
- G  Llave *1

⚠ ANTES DE COMENZAR, UNOS CONSEJOS:

 Tener un amigo que te ayude facilita mucho el ensamblaje.

 Por favor, utiliza la llave incluida en lugar de un TALADRO ELÉCTRICO para evitar daños al producto.

INSTRUCCIONES DE MONTAJE

Nota: Antes de la instalación, por favor retire cada componente del sofá.

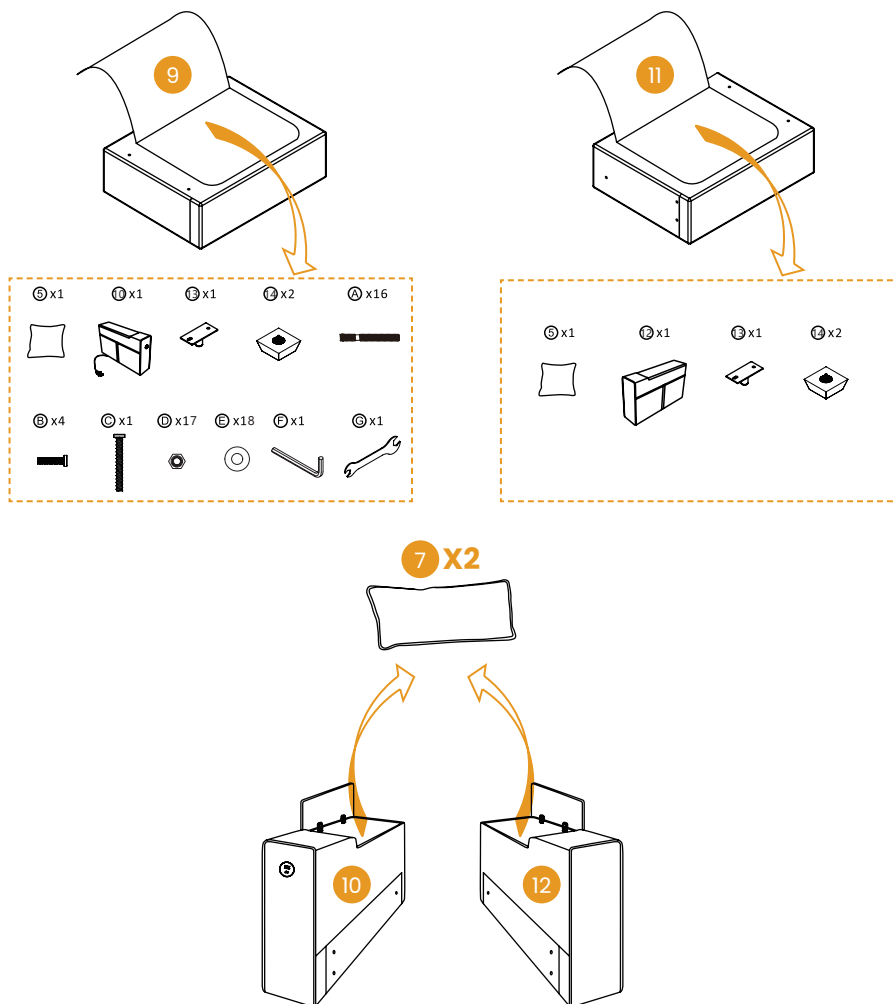

INSTRUCCIONES DE MONTAJE

PASO 1 Apriete el extremo más corto del Perno de perno (A) en los Soportes del respaldo (8) del sofá. Tenga en cuenta que hay dos Soportes del respaldo (8) en total, y se deben apretar cuatro Pernos de perno (A) en cada Soporte del respaldo (8).

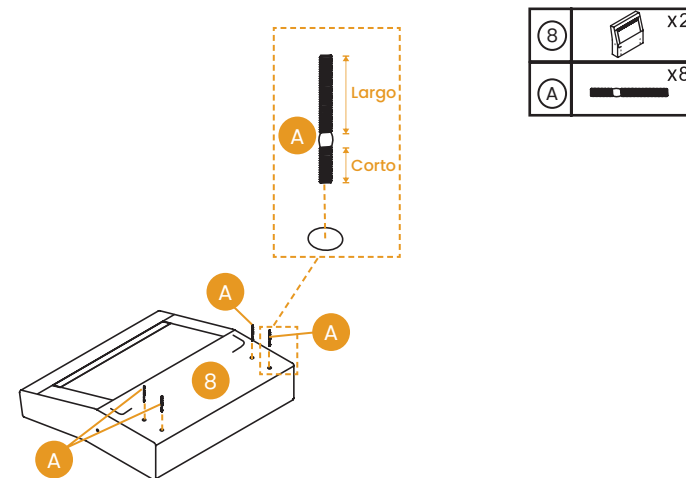



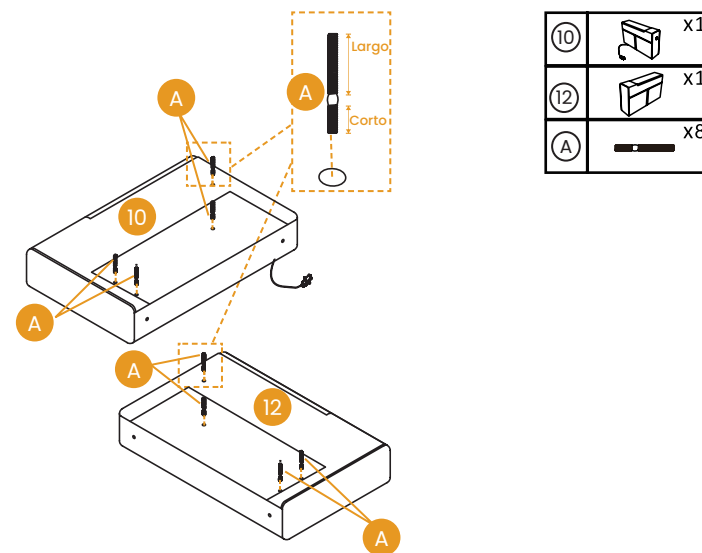

PASO 2 Apriete el extremo más corto del Perno de perno (A) en los Reposabrazos (10 y 12) del sofá. Tenga en cuenta que cada Reposabrazos necesita cuatro Pernos de perno (A).



INSTRUCCIONES DE MONTAJE

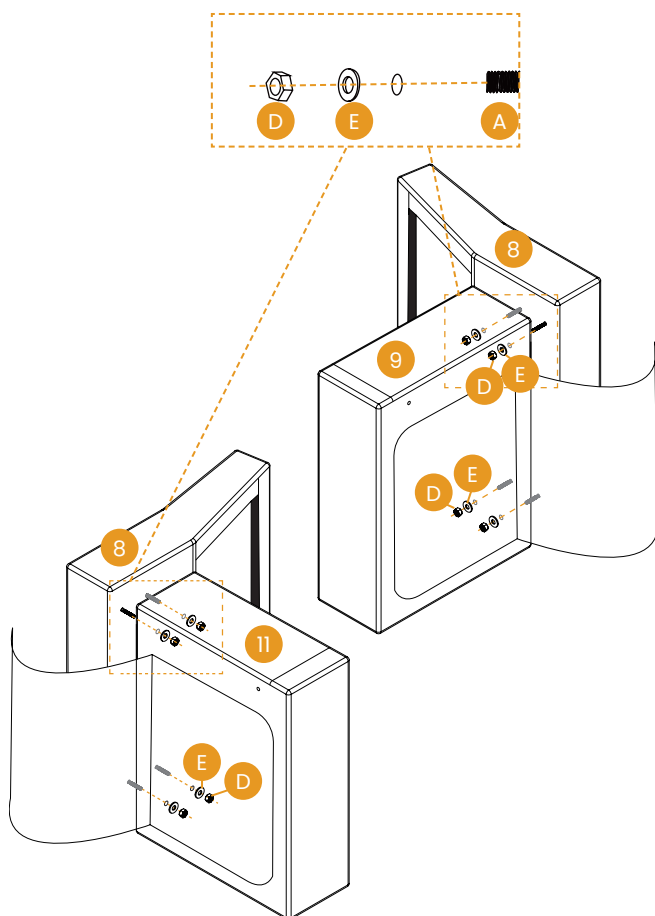

PASO 3 Abra la cubierta de la base del sofá en la parte inferior de los Soportes del respaldo (8), luego conecte los Soportes inferiores (9 y 11) con los Soportes del respaldo (8). Cada Perno de perno (A) debe emparejarse con una Tuerca hexagonal (D) y una Arandela plana (E) para su uso, utilizando la Llave (G).

9		x1
11		x1
D		x8
E		x8



INSTRUCCIONES DE MONTAJE

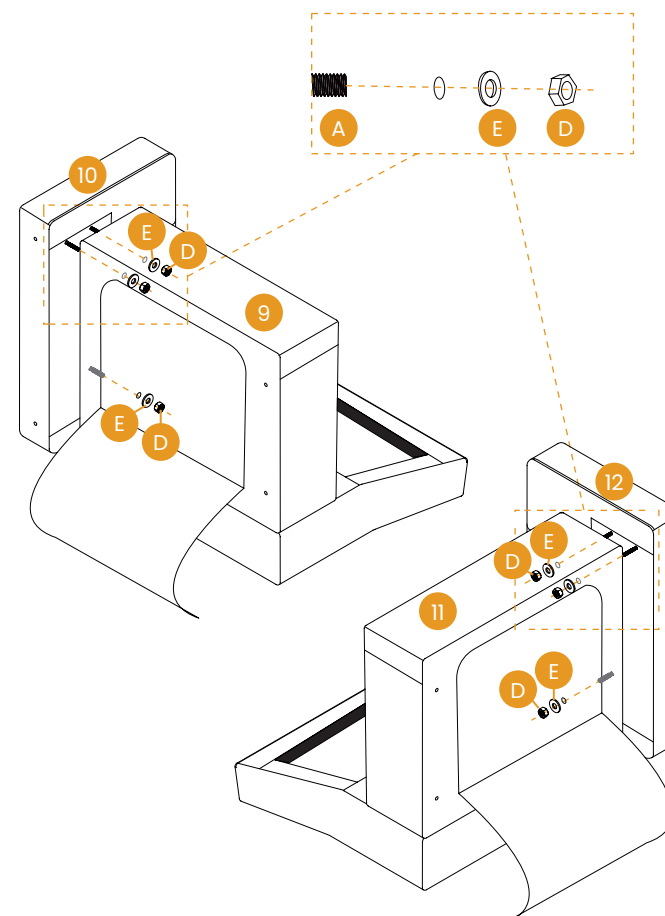

PASO 4 Abra la cubierta de la base del sofá en la parte inferior de los dos Soportes del respaldo (8), luego conecte el Soporte inferior izquierdo (9) con el Reposabrazos izquierdo (10) y el Soporte inferior derecho (11) con el Reposabrazos derecho (12). Cada Perno de perno (A) debe emparejarse con una Tuerca hexagonal (D) y una Arandela plana (E) para su uso, utilizando la Llave (G).

D		x6
E		x6





INSTRUCCIONES DE MONTAJE

PASO 5 Abra la cubierta del Soporte del respaldo en el lado izquierdo, luego use una Tuerca hexagonal (D) y una Arandela plana (E) para fijarlo, utilizando la Llave (G).

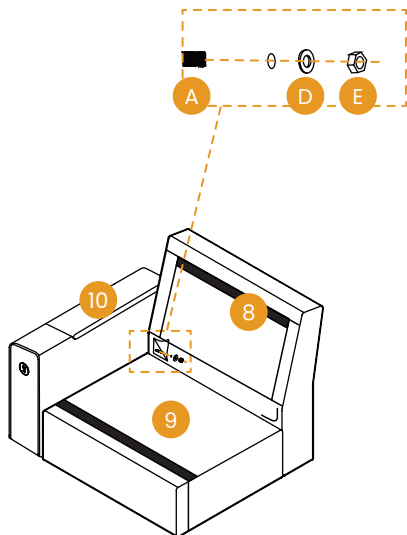
ⓓ		x1
ⓔ		x1



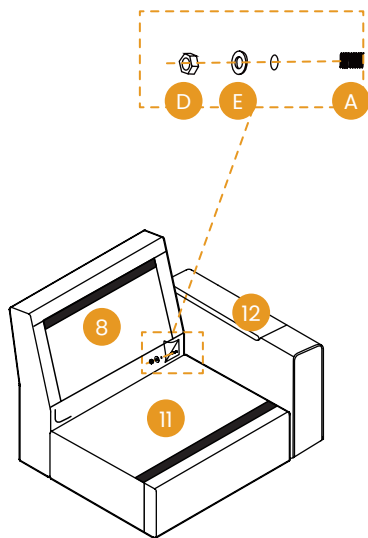

PASO 6 Abra la cubierta del Soporte del respaldo en el lado derecho, luego use una Tuerca hexagonal (D) y una Arandela plana (E) para fijarlo, utilizando la Llave (G).

ⓓ		x1
ⓔ		x1



INSTRUCCIONES DE MONTAJE

PASO 7 Abra la cubierta del Soporte del respaldo en la posición neutral, luego inserte un Perno de perno (A) del lado izquierdo al lado derecho con una Arandela plana (E), finalmente use una Tuerca hexagonal (D) y una Arandela plana (E) para fijarlo en el otro lado, utilizando la Llave (G).

Ⓒ		x1
ⓓ		x1
ⓔ		x2

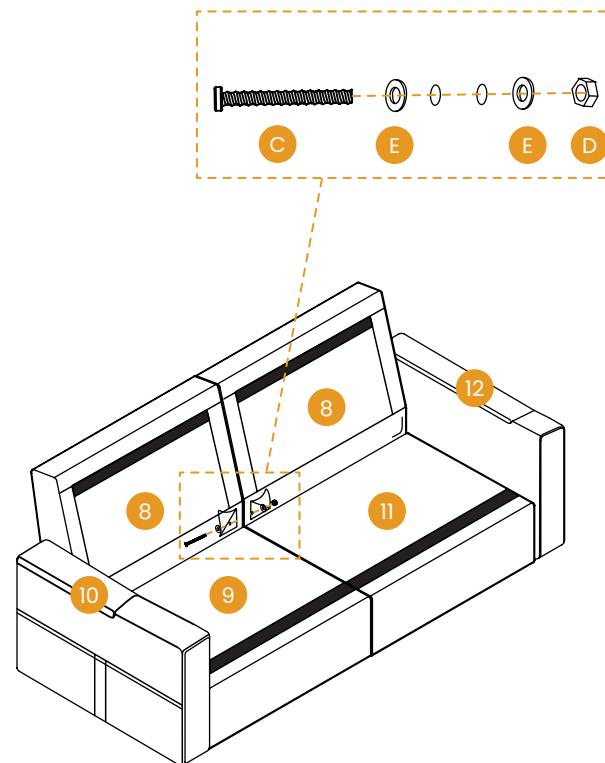

INSTRUCCIONES DE MONTAJE

PASO 8 Fije las Placas base (13) en la parte inferior del sofá según la posición mostrada en la imagen con cuatro Pernos cortos (B), utilizando la Llave hexagonal (F).

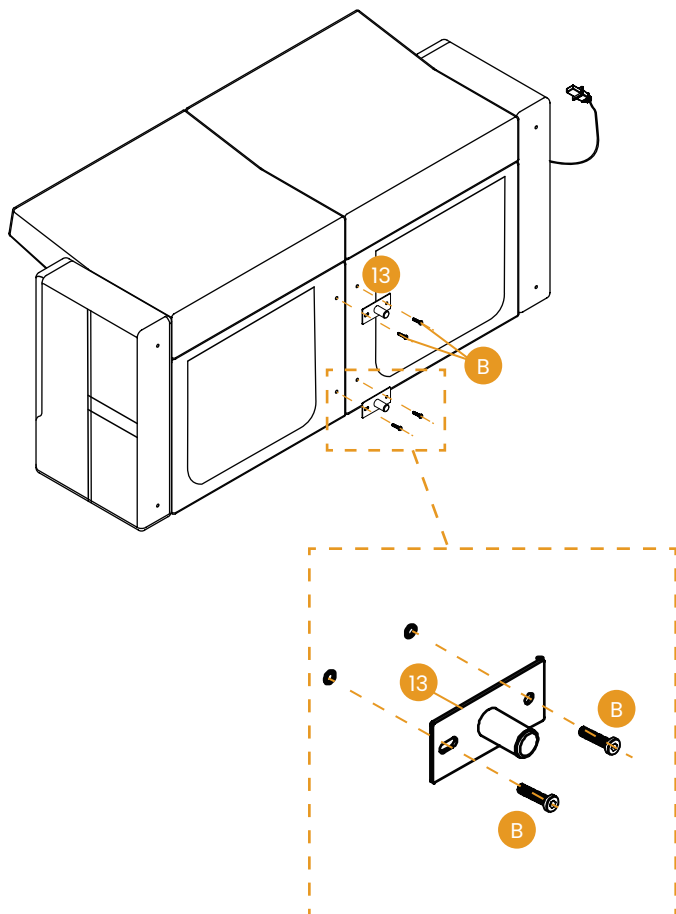
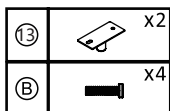

INSTRUCCIONES DE MONTAJE

PASO 9 Instale los cuatro Pies (14) en la parte inferior del sofá.

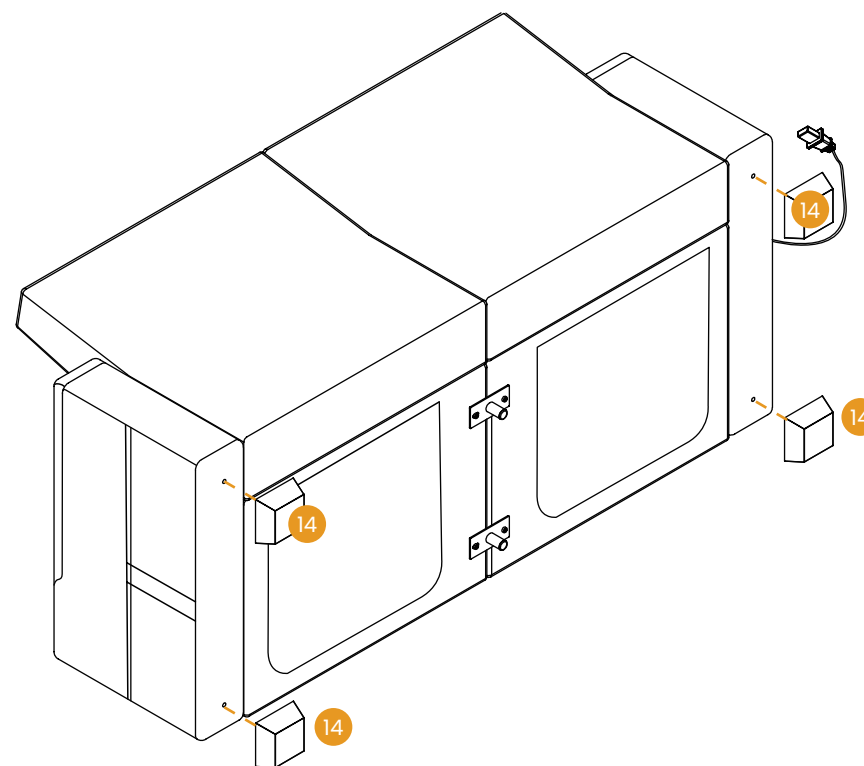
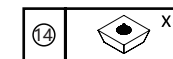

INSTRUCCIONES DE MONTAJE

PASO 10 Abra la bolsa que contiene la Esponja del cojín del asiento (1) y haga que se esponje, luego coloque la Funda del cojín (6). Coloque los dos Cojines del asiento sobre los Soportes inferiores (9 y 11).

Nota: Hay una señal de indicación hacia adelante en el cojín del asiento.

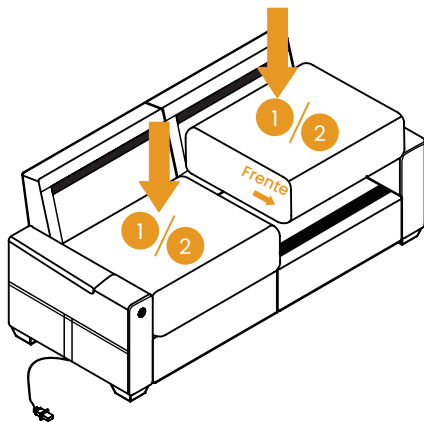
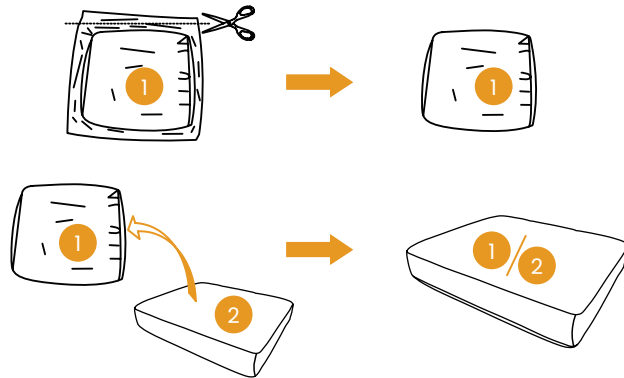
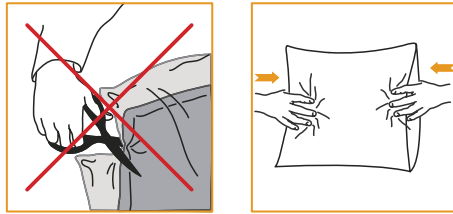
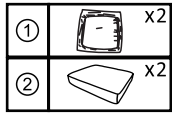

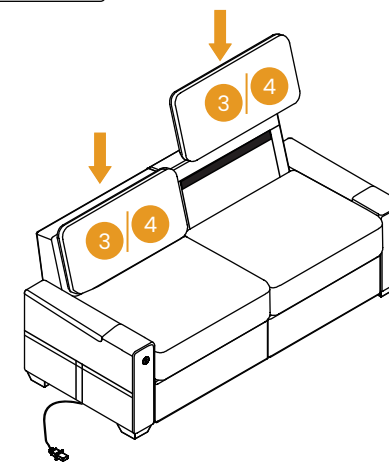
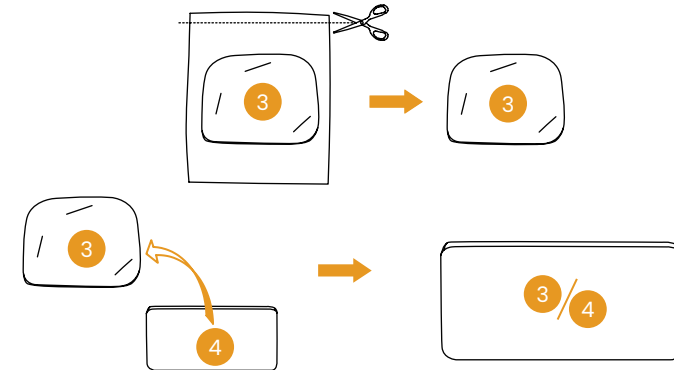
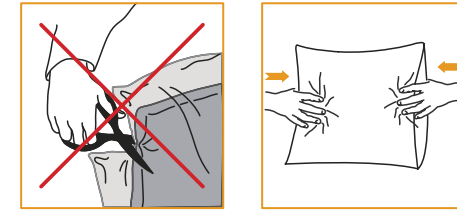
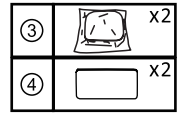

INSTRUCCIONES DE MONTAJE

PASO 11 Abra la bolsa que contiene la Esponja del cojín del respaldo (3) y haga que se esponje, luego coloque la Funda del cojín del respaldo (4). Coloque los dos Cojines del respaldo sobre los Cojines del asiento.



INSTRUCCIONES DE MONTAJE

PASO 12 Coloque el Inserto del cojín decorativo (5) en la Funda del cojín (6), luego coloque el Cojín y el Cojín decorativo lateral (7) en la posición correspondiente del sofá.

⑤		x2
⑥		x2
⑦		x2

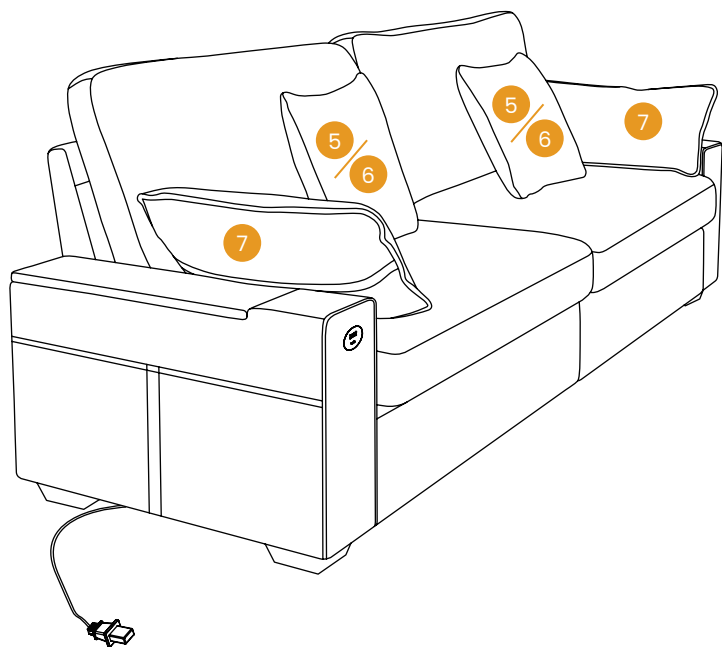
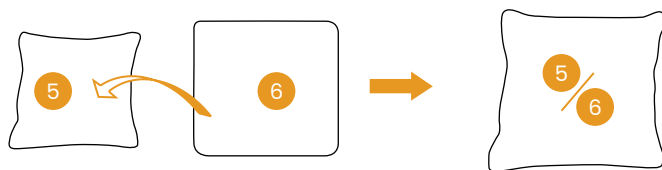

INSTRUCCIONES DE MONTAJE

PASO 13 Hay una cubierta de plástico en el enchufe. Retire la cubierta y luego conéctelo para usarlo.

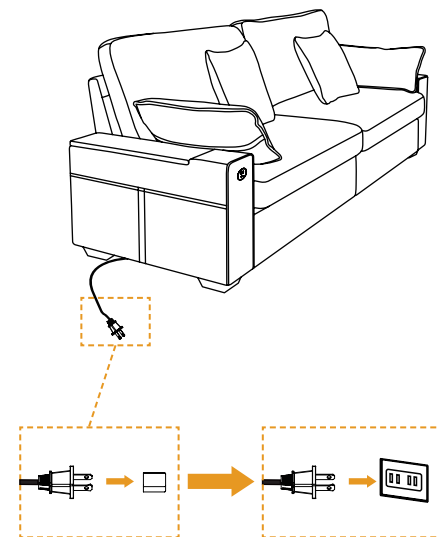

PASO 14 Ahora, su sofá está correctamente instalado.

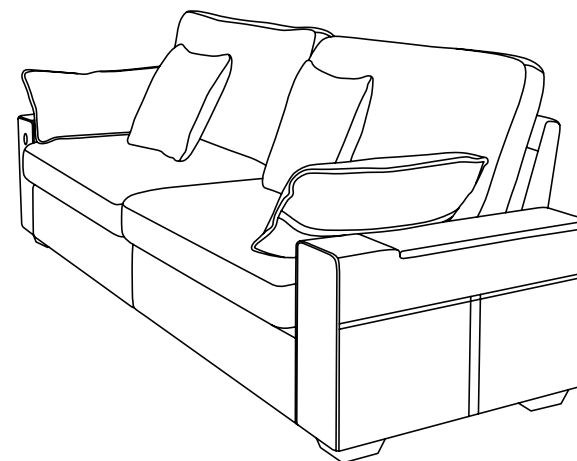

GARANTÍA LIMITADA

Prometemos reparar o reemplazar cualquier producto que se encuentre defectuoso en material o mano de obra dentro de un año desde la fecha de compra original, siempre que usted, el comprador original, aún lo posea. Esta es su única y exclusiva solución bajo esta garantía, sujeta a las disposiciones descritas a continuación.

EXCLUSIONES

Esta garantía no cubre, y ninguna otra garantía se aplica a:

- Desgaste y deterioro normales, lo cual es de esperarse con el uso a lo largo del tiempo.
- Uso indebido, abuso o uso excesivo del producto.
- Modificaciones o accesorios no aprobados para el producto.
- Productos que no hayan sido instalados, utilizados o mantenidos de acuerdo con las instrucciones y advertencias del producto.
- Productos utilizados para fines de alquiler o actividades comerciales no autorizadas.

Uso del producto: El uso normal del producto se define como equivalente a un solo turno de trabajo de cuarenta (40) horas semanales. Si el producto se utiliza de una manera que exceda esto, el período de garantía aplicable se reducirá proporcionalmente.

POLÍTICA DE DEVOLUCIONES

Ofrecemos una política de devolución de 30 días, lo que significa que todos los productos comprados pueden ser devueltos dentro de ese plazo. Debe ponerse en contacto con nosotros por correo electrónico o por teléfono de atención al cliente dentro de los 30 días posteriores a la recepción del/los producto(s), y deben devolverse sin demoras indebidas.

CONDICIONES:

- Los productos devueltos deben estar en las mismas condiciones en que fueron recibidos y en su embalaje original.
- Si el producto no presenta fallos (es decir, si cambia de opinión o no está satisfecho con el producto por otra razón), usted será responsable del coste del envío de devolución. Debe asegurarse de que el paquete llegue en buen estado, por lo que recomendamos utilizar un servicio de mensajería con seguimiento.

GARANTÍA LIMITADA

- Si el producto presenta defectos al momento de la recepción, por favor contáctenos y le asistiremos con la devolución, cubriendo los gastos de envío en este caso.
- Nos reservamos el derecho de ofrecer reembolsos parciales para productos devueltos que no se encuentren en estado sin uso, estén dañados o tengan piezas faltantes que no sean atribuibles a nuestro error.

CÓMO FUNCIONAN LAS DEVOLUCIONES

Para solicitar una devolución, adjunte una copia de su factura como comprobante de compra, junto con el motivo de la devolución.

Le proporcionaremos la dirección de devolución del producto lo antes posible. Una vez que el producto devuelto sea recibido e inspeccionado, le ofreceremos una resolución específica.

Si la devolución es aprobada, el importe del reembolso se acreditará automáticamente a su método de pago original.

INSTRUCCIONES DE MANTENIMIENTO

Limpie el polvo y limpie las manchas de inmediato usando un paño limpio, no coloreado y sin pelusa.



Use una solución de jabón suave y un paño húmedo para eliminar las manchas.



No coloque objetos calientes directamente sobre la superficie de los muebles sin usar una barrera protectora.



Solo para uso en interiores. No coloque los muebles afuera.



No coloque los muebles a la luz directa del sol.



No escriba sobre la superficie de los muebles sin una barrera acolchada para protegerla.



No limpie los muebles con limpiadores o pulidores agresivos.



No coloque los muebles cerca de las rejillas de calefacción o refrigeración (mantenga al menos 3 pies de distancia).