

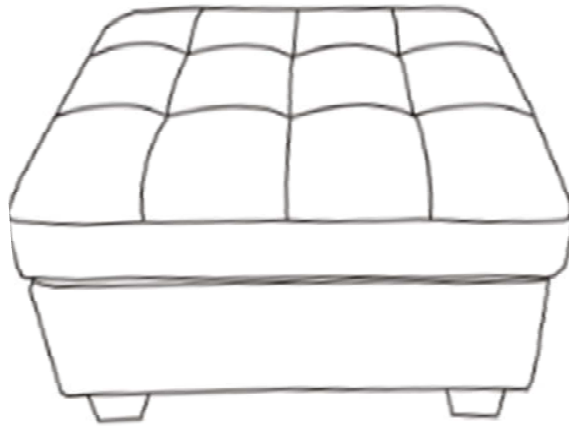

Assembly Instructions

Caution : You must read this before you proceed

OTTOMAN

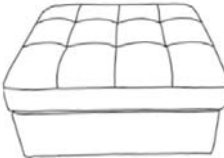

Parts List

Label	Picture	Description	QTY
A		Ottoman	1
B		Leg	4

Hardware

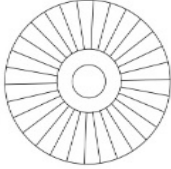
Label	Picture	Description	QTY
①		Gasket	7

Assembly Preparation

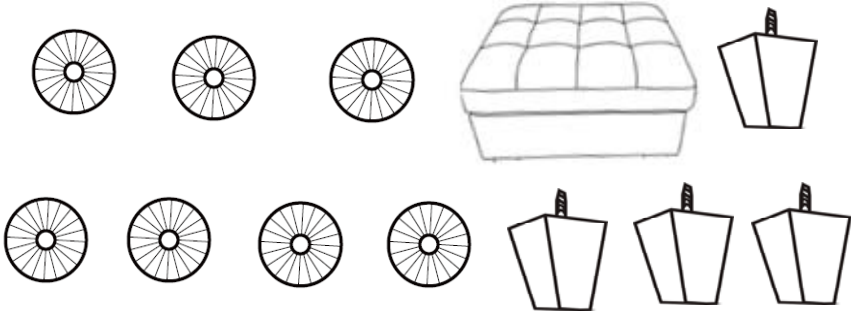
<p>Before Beginning Assembly:</p>	
-----------------------------------	---



- Read instructions, cover to cover-



- Have 2 adults on hand for assembly-



- Do not assemble on flooring or carpet-



- Assemble on a clean non-marring surface (packing foam)-



- Save all packaging until finished-

Assembly Steps

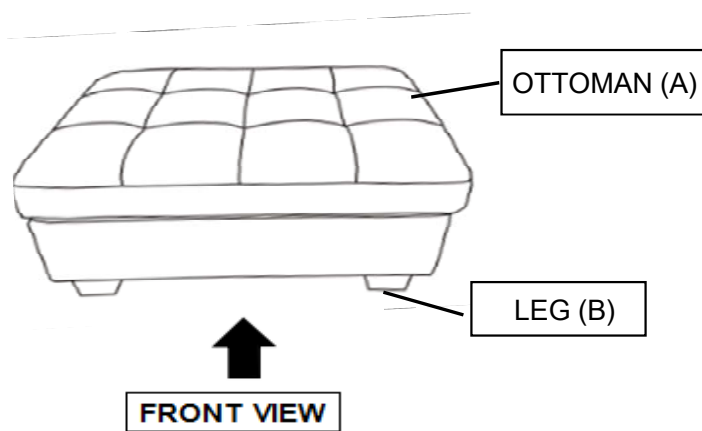

This Ottoman has multiple parts and may require up to some 30 minutes to assemble. To give you an overview of the sofa parts, the above picture is to help you put the various parts into perspective. Please read through the instructions below to familiarise yourself with the parts and steps before assembly.

Step 1



Open the flap under the Ottoman, then pull out the Black Bag containing the Legs(B) and Gaskets(①).

Step 2

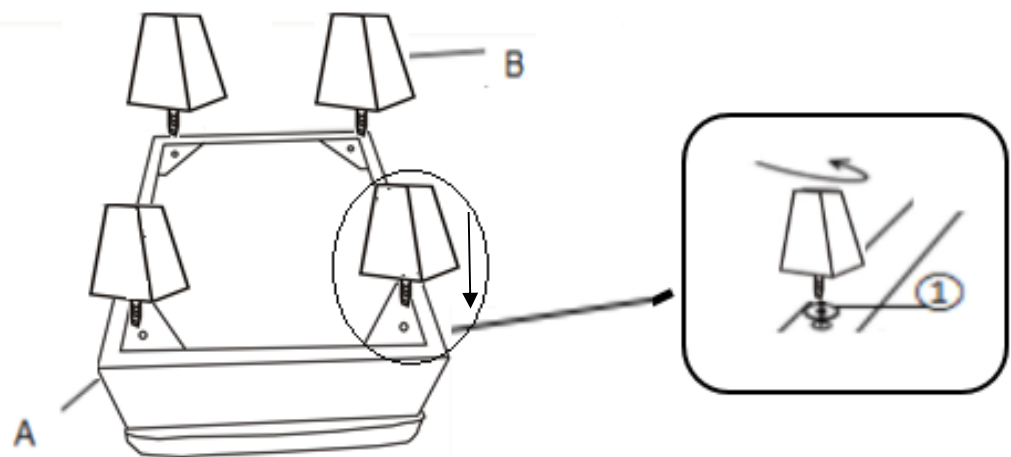

Install the first Leg(B) into the bottom of the Ottoman by placing one Gasket(①) on the threaded stem.

The use of the Gasket can improve tightness and security of Leg.

Tighten by turning the Leg clockwise.

Repeat the same step to install the three remaining Legs(B).

Note : The use of Gaskets are OPTIONAL and are especially useful to help alleviate slight wobbles. Some Legs may need more than one whilst some Legs do not require any.

Step 3

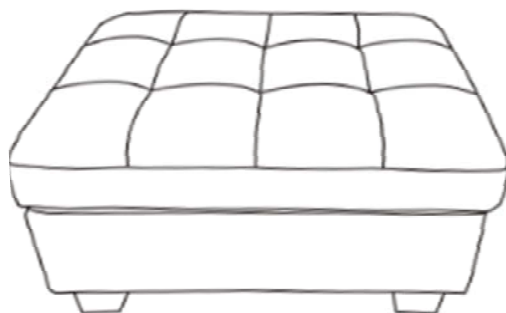





















Stand the Ottoman right side up, test for levelness on a flat surface.

Where you find this Ottoman being uneven, identify the corresponding Leg and "add or remove" a Gasket to achieve evenness.

Your Ottoman is ready for use.

Caution: This Ottoman can only be used on a flat, level surfaces.

Care & Maintenance

-   • Do not put hot items directly on furniture surface
 -   • Do not clean furniture with harsh cleansers or polish.
 -   • Do not place furniture under direct sunlight.
 -   • Do not place furniture near heating or cooling vents.
 -   • Do not write on furniture without a padded barrier to protect the surface.
 -   • Do not place furniture outside . For indoor use only .
 -   • Not for commercial use. For residential use only .
 -   • Stains may be removed with mild soap solution and damp cloth.
 -   • Children should not climb or jump on the furniture.
-
-   • Dust and pick-up spills using a clean, non-colored, lint-free cloth .