

PP322590

Assembly Instruction
Montageanleitung



PP322590

A



1PCS

B



1PCS

C

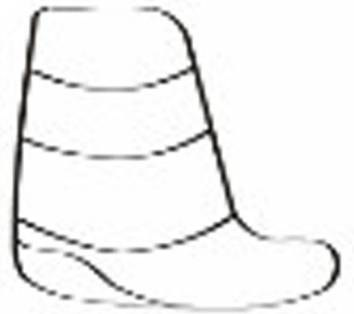

1PCS

D



1PCS

E



M6*14MM 4 + 1PCS



F



1PCS

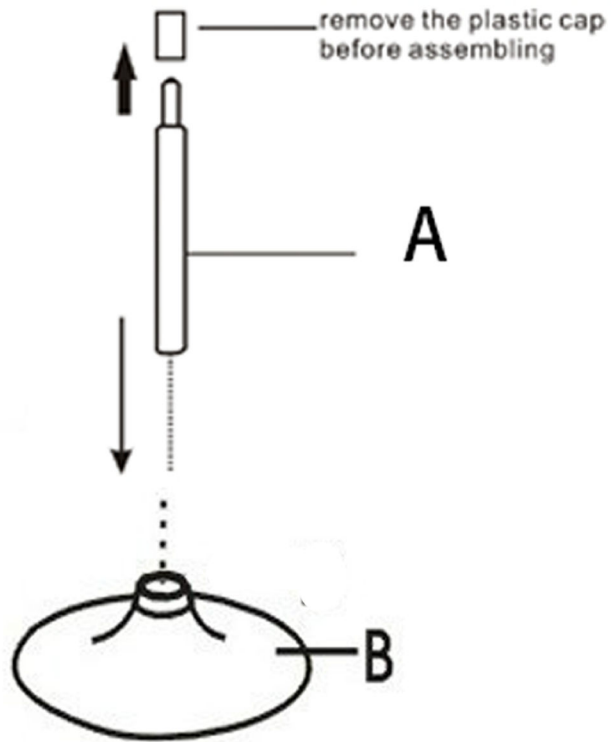

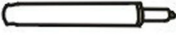

Step 1

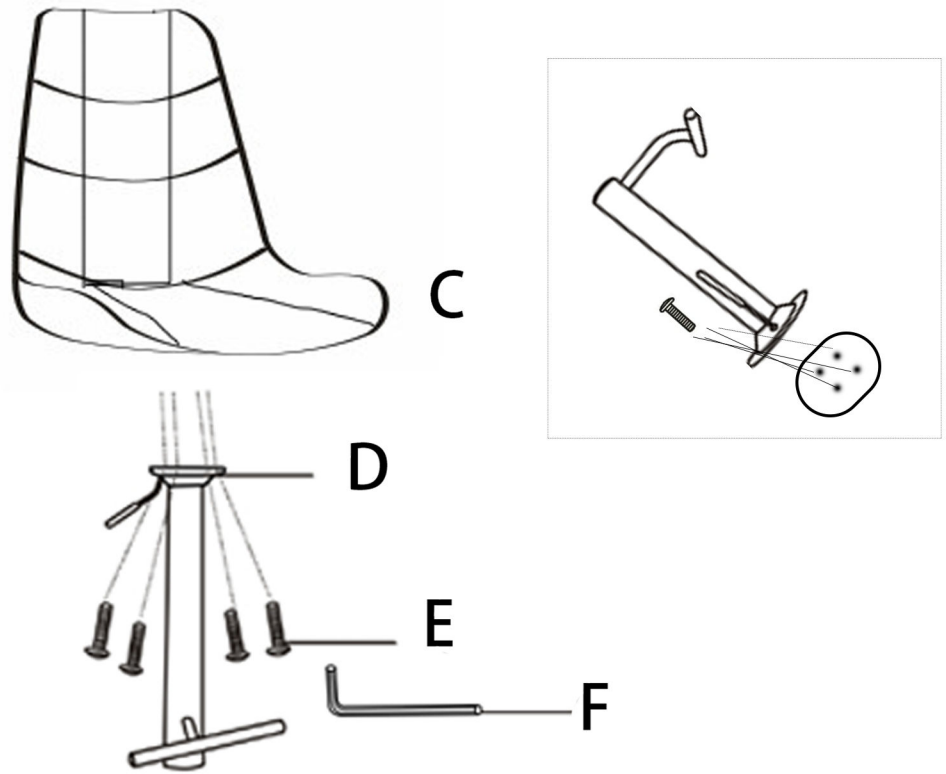

	A*1PCS
	B*1PCS

Step 2



	C*1PCS
	D*1PCS
	E*4PCS
	F*1PCS

Step 3

