

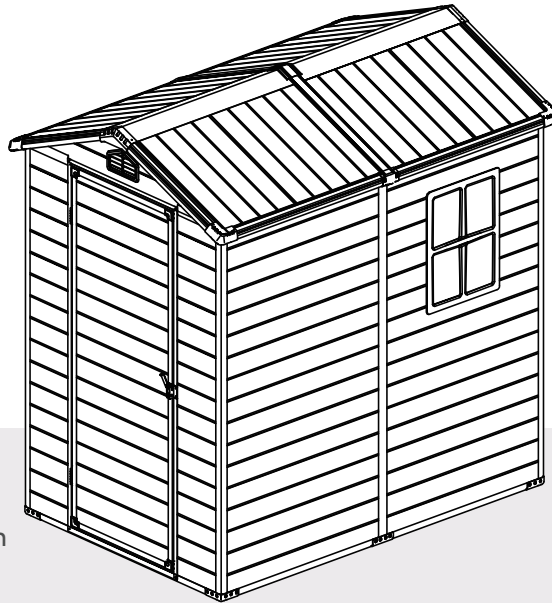

MANUAL INSTRUCTION



RESIN GARDEN SHED



Reach us at:

 service@kmcglobe-us.com

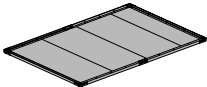
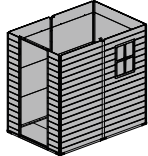
 (only us) +1 213-816-4788

part 1: Precautions and preparations	3-7
part 2: Material list (please check before installation)	8-13
part 3: Foundation installation	14-25
	
part 4: Cabinet installation	26-34
	
part 5: Roof installation and internal fixing	35-44
	
part 6: Door installation and adjustment	45-49
	
part 7: Help Center	50

Outdoor Furniture

We are a professional furniture provider with top-notch factories and outstanding designs, Our mission is to provide consumers with new lifestyles. By collecting consumer feedback, we constantly improve our products and create more choices for consumers. If you want to create your space, We are an ideal choice.

Always.

I BEFORE YOU START

Owner's Manual

Prior to installation, it is important that you contact your local government authority to determine if building approval is required. Study and understand this owner's manual. Important information and helpful tips will make your construction easier and more enjoyable.

Assembly instructions

Instructions are supplied in this manual and contain all appropriate information for your building model. Review all instructions before you begin. During assembly, follow the step sequence carefully for correct results. Please be aware: this unit takes two people about one full day to complete.

Parts

Check to be sure that you have all the necessary parts for the building. Separate contents of the carton by the part number while reviewing parts list. Familiarize yourself with the hardware and fasteners for easier use during construction. These are packaged within the carton. Note that extra fasteners have been supplied for your convenience.

TOOLS MAY REQUIRED

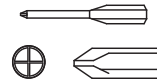
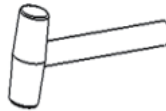
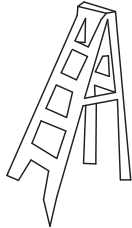

Use heavy duty gloves when handling steel sheets and flashing.

PLAN AHEAD

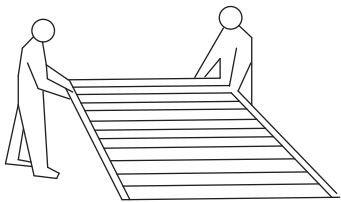

Watch the weather:

Please be sure the day you select for installation is dry and calm.

DO NOT attempt to assemble your shed in windy weather because of risk of damage to panels, or personal injury. Be careful of wet or muddy ground.

Teamwork:

Whenever possible, two or more people should work together to assemble the building. One person can position parts or panels while the other is able to handle the fasteners and the tools.

I PLAN AHEAD

Site Selection

- Avoid overhanging trees as much as possible as leaves will make regular cleaning necessary and broken branches are a potential hazard.
- Small trees, bushes or fences nearby can be helpful, acting as a wind break

Site Preparation

The site must be prepared so that the base of the shed is level all round and checking with a spirit level is required.

The base can be constructed by treated timber or concrete, in order to stop the moisture getting into the shed. The shed is not designed to be built onto lawn directly. Also the ground will get muddy during rainy days.

If a concrete pad is made, it is important that this slopes towards the edges to prevent water ingress.

Time must be allowed for any concrete or cement to dry before building the shed on top

Bases can also be constructed from bricks, blocks, or mounted on a concrete pad. The bricks or blocks should be cemented onto firm and level concrete footings and the greenhouse frame drilled and screwed to the base.

I IMPORTANT NOTES





- Find someone to help you: it is much easier with someone to hold parts, pass tools ect ALSO some steps require two people to lift structures together This is not very heavy work SO would suit most able-bodied people.
- Allow plenty of time: rushing often causes errors and the re-doing of incorrect assemblies If you have never built a shed before, it can take most of a day to carefully complete the construction.
- Have the right tools to hand.
- Safety clothing as recommended in the 'Tools' section.
- Ideally lay out the parts and check that all are present before commencing construction. Lay on cloths or plastic sheets if there is any risk of scratching the parts.
- Tighten all nuts carefully, being sure not to miss any. Check the frame is square and using a spirit level to check that it is upright.

Part 2: Material list

As this item contains many parts, please read the installation instruction carefully before installation. Please use tools properly and carefully. If you have any questions about the product and installation, please contact us.

(please check before installation)

HARDWARE

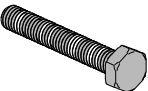
	ST4.2x13mm E01 X 20		M6x8.5mm E09 X 6
	ST4.2x12mm E02 X 351		M4x10mm E12 X 12
	ST4.8x19mm E03 X 32		
	ST5.5x50mm E04 X 6		
	ST4.2x55mm E07 X 4		
	M6x50mm E08 X 6		

PARTS

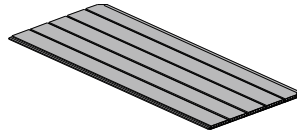

A64-C01 X 1

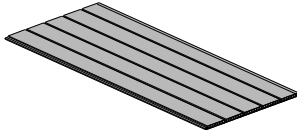

A64-C02 X 5

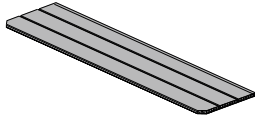

A64-C03 X 1

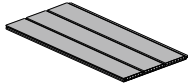

A64-C04 X 4

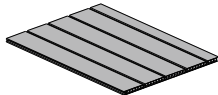

A64-C05 X 1

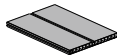

A64-C06 X 2

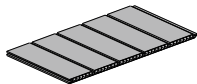

A64-C07 X 6

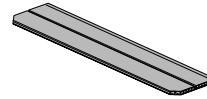

A64-C08 X 4

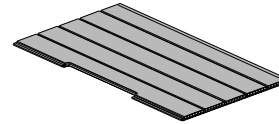

A64-C09 X 1

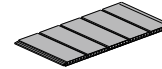

A64-C10 X 2

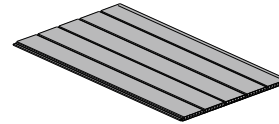

A64-C11 X 10

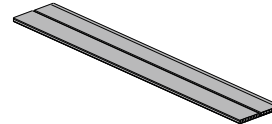

A64-C12 X 1

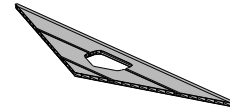

A64-C13 X 2

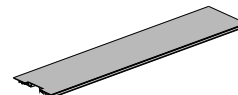

A64-C14 X 2

PARTS

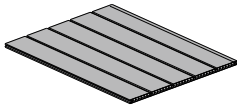

A64-V4-C01 X 4

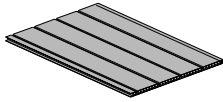

A64-V4-C02 X 4



A64-C17 X 4

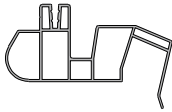

A64-C18 X 4



A64-C18-1 X 4



A64-C17-1 X 4

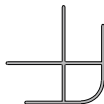

A64-C19 X 4

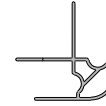

A64-C21 X 4

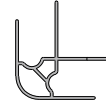

A64-C22 X 2

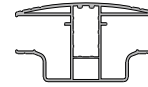

A64-C24 X 2

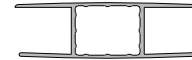

A86-V4-C05 X 2

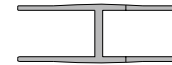

A64-C26 X 1

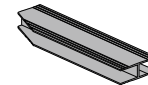

A64-C27 X 2

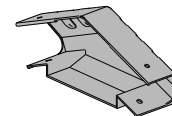

A64-C29 X 2

PARTS

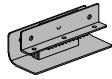

A64-C30 X 2



A64-C31 X 2

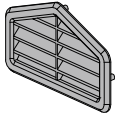

A64-C32 X 2

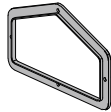

A64-C33 X 2

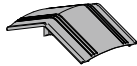

A64-C34 X 1



F35-C27 X 4



F35-C29 X 4



F35-C30 X 4



F35-C31 X 1

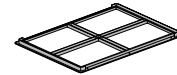

F35-C32 X 1

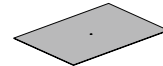

F35-C33 X 1

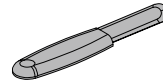

F35-C34 X 1

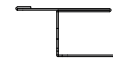

A86-V4-A01 X 1



A64-A02 X 1

PARTS

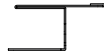

A64-V4-A01 X 1



A86-V4-A07 X 2



A64-A05 X 1



A64-V4-A05 X 2



A64-A06 X 2



A64-V4-A06 X 1



A64-V4-A02 X 1



A64-V4-A07 X 1



A64-V4-A03 X 4



A64-A15 X 2

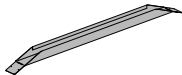

A64-V4-A04 X 2



D02 X 1

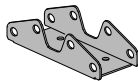

A86-V4-A06 X 1

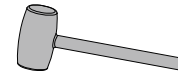

D03 X 1

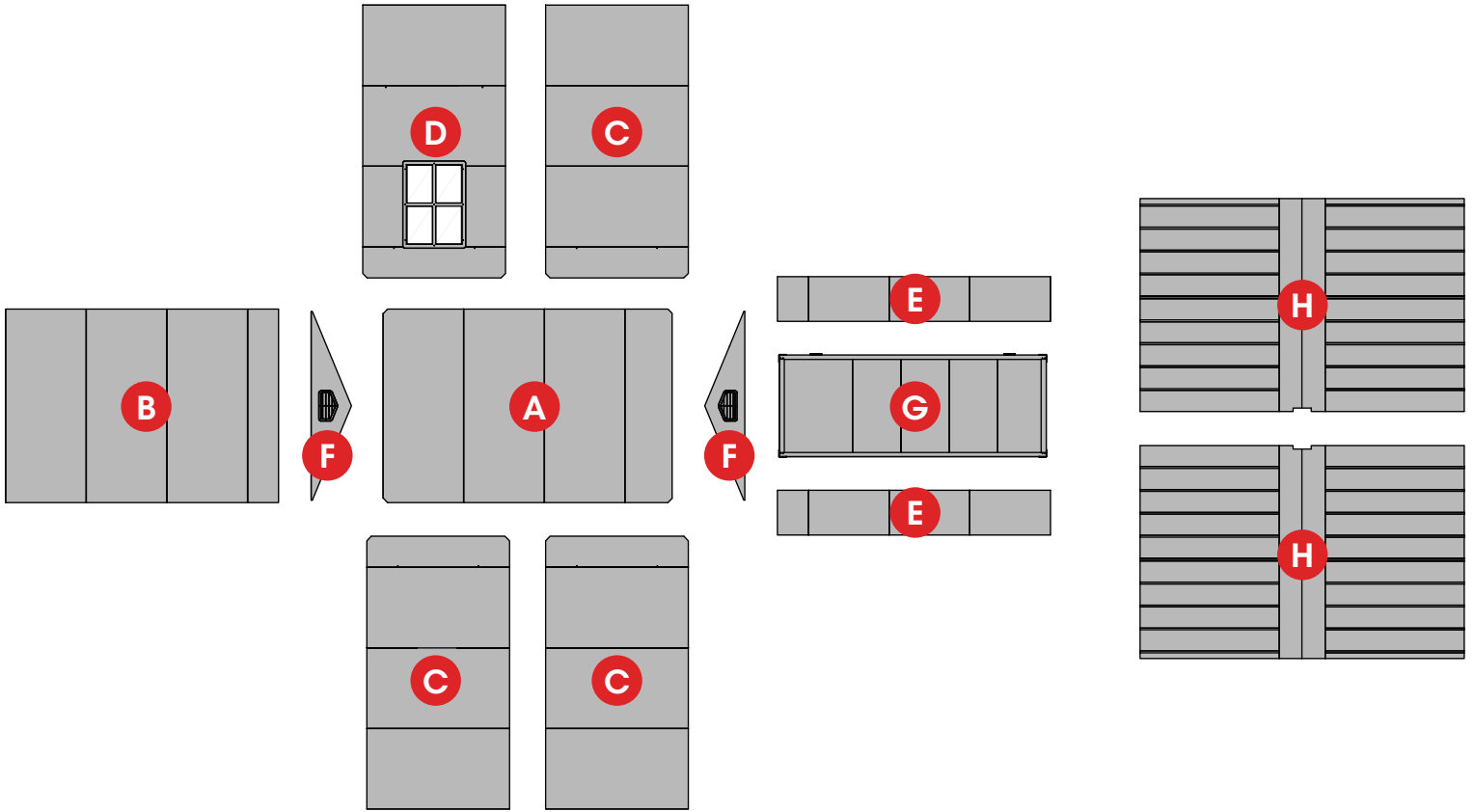

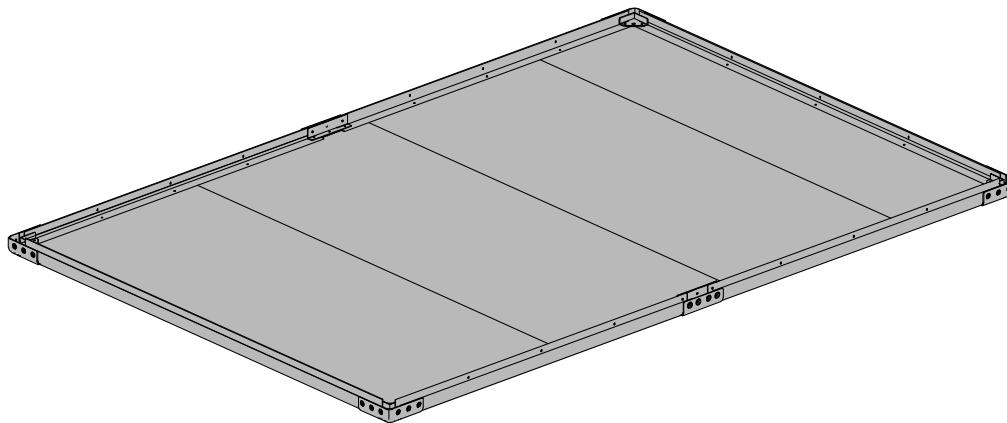

Part 3: Foundation installation

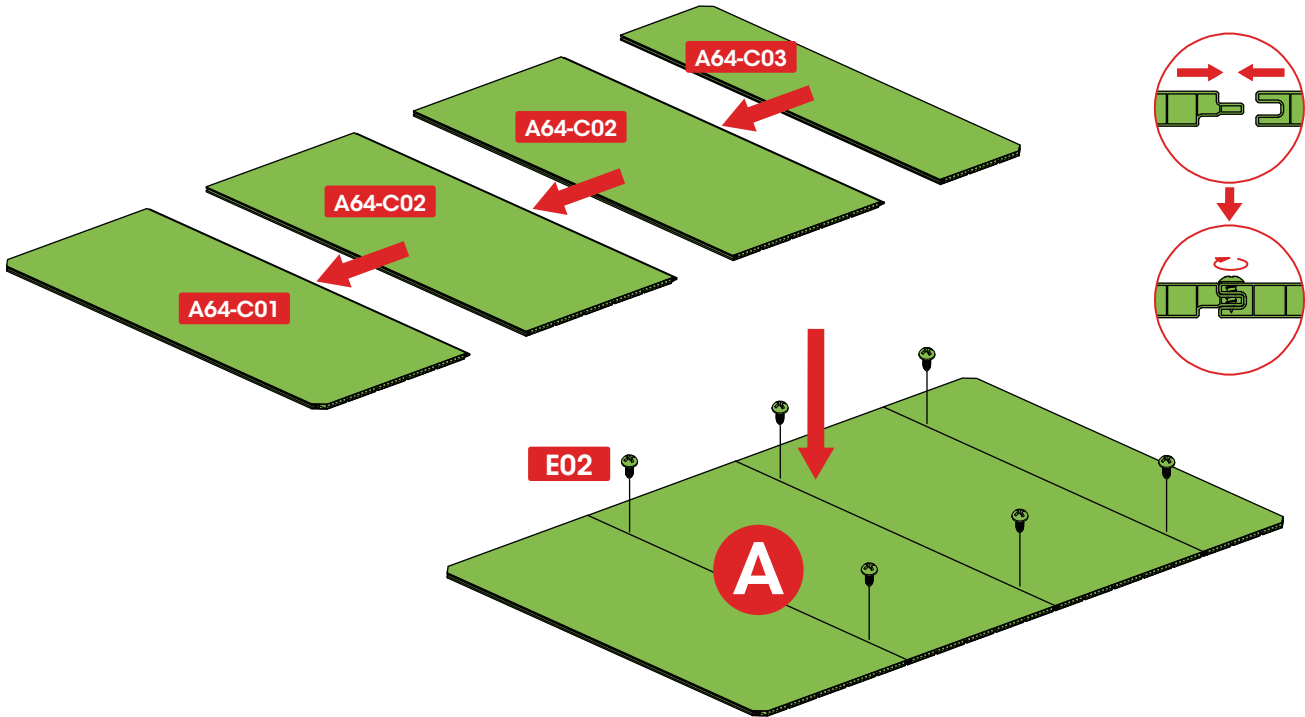
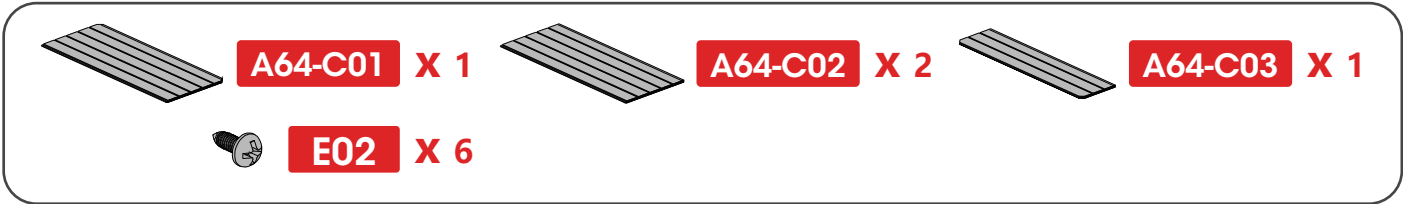

1



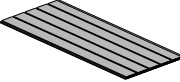
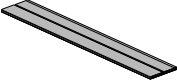

2

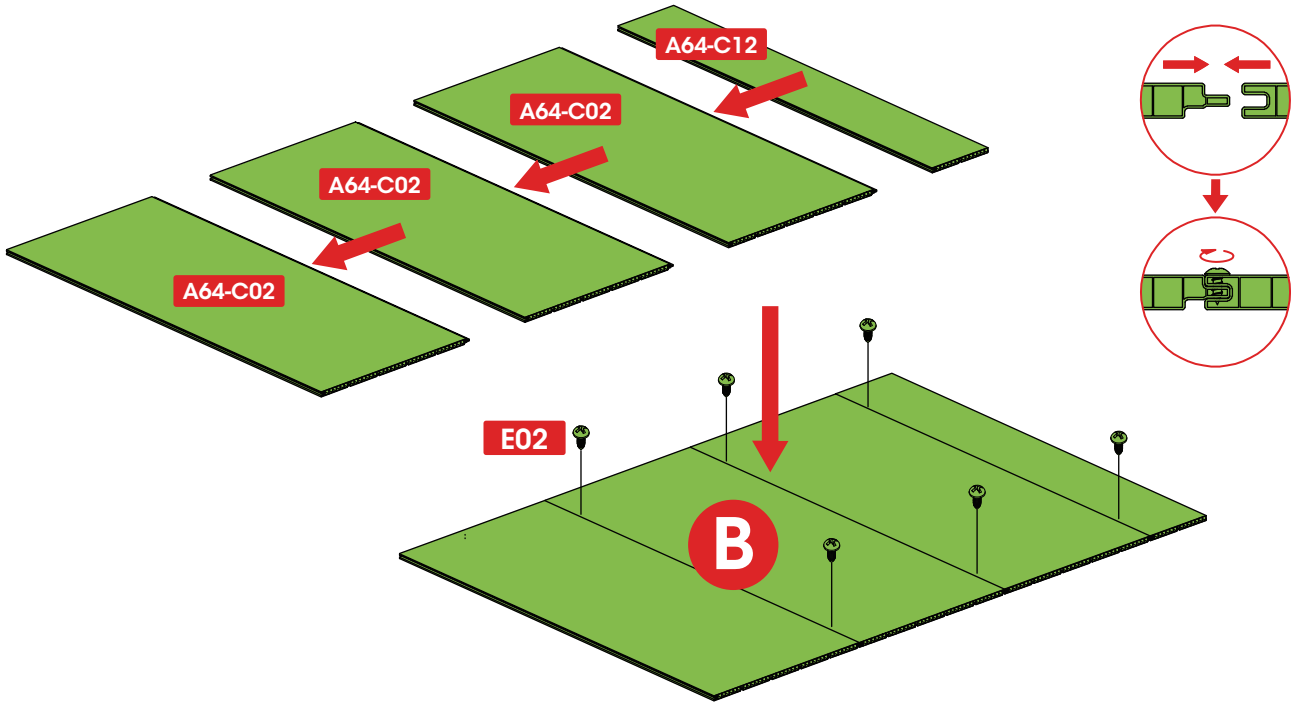
 **A64-C02 X 3**  **A64-C12 X 1**  **E02 X 6**

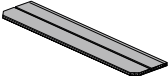
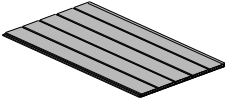

3

 **A64-C08** X 3  **A64-C11** X 9  **E02** X 18

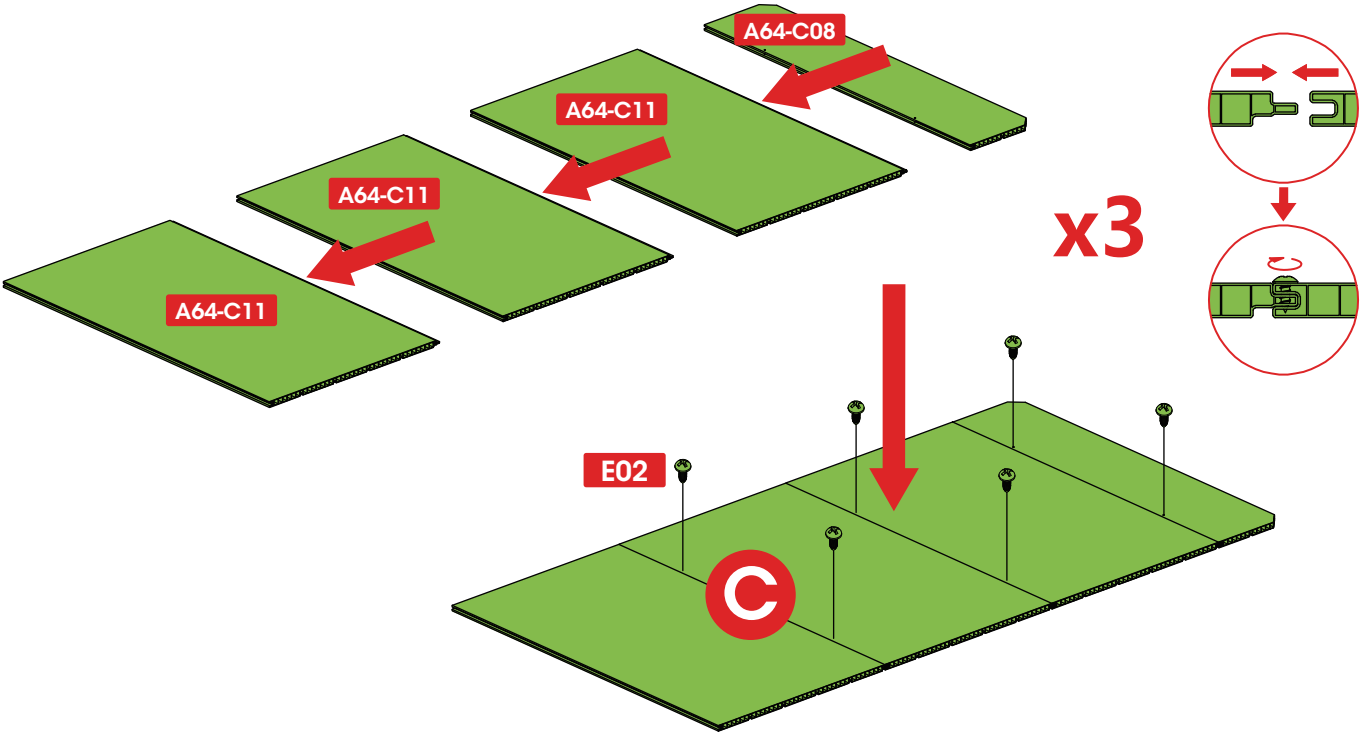

4

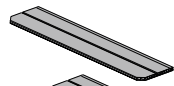

A64-C08 X 1

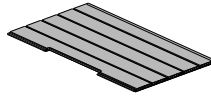

A64-C09 X 1

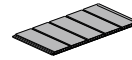

A64-C10 X 2

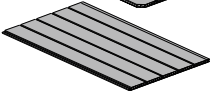

A64-C11 X 1



E02 X 6

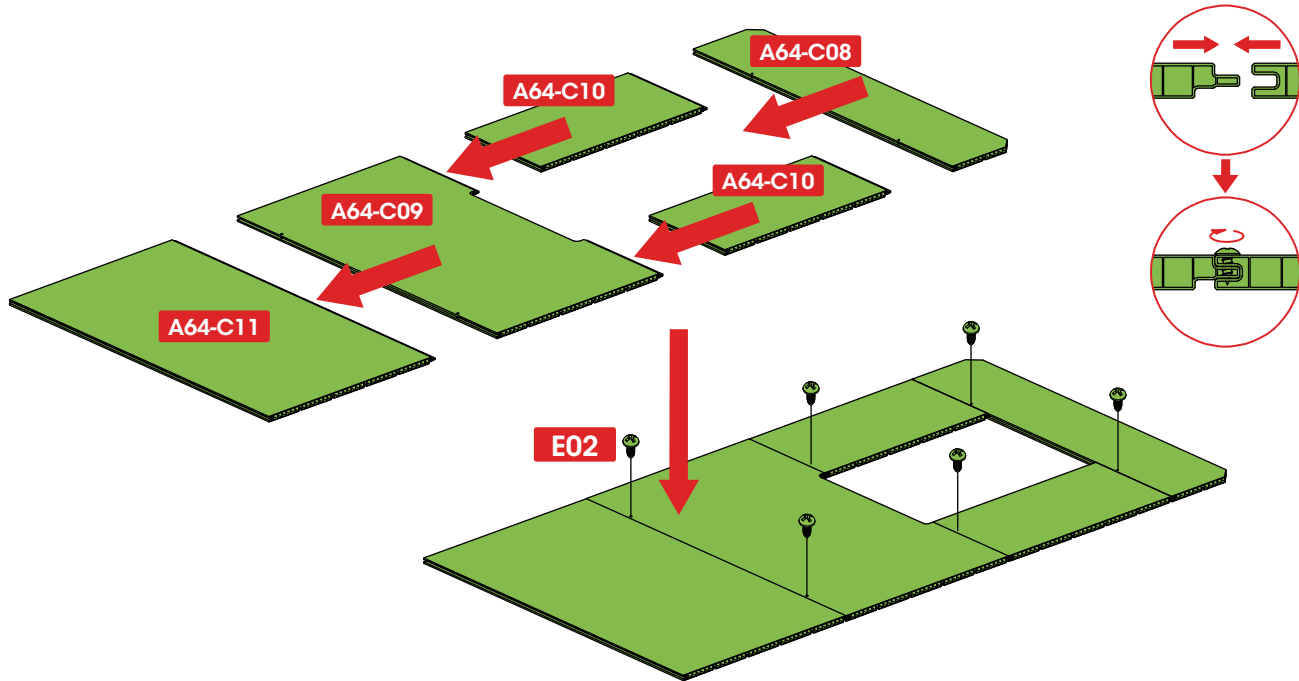

5

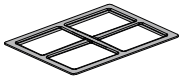

F35-C31 X 1

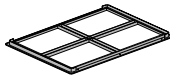

F35-C32 X 1

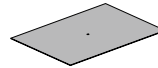



F35-C33 X 1

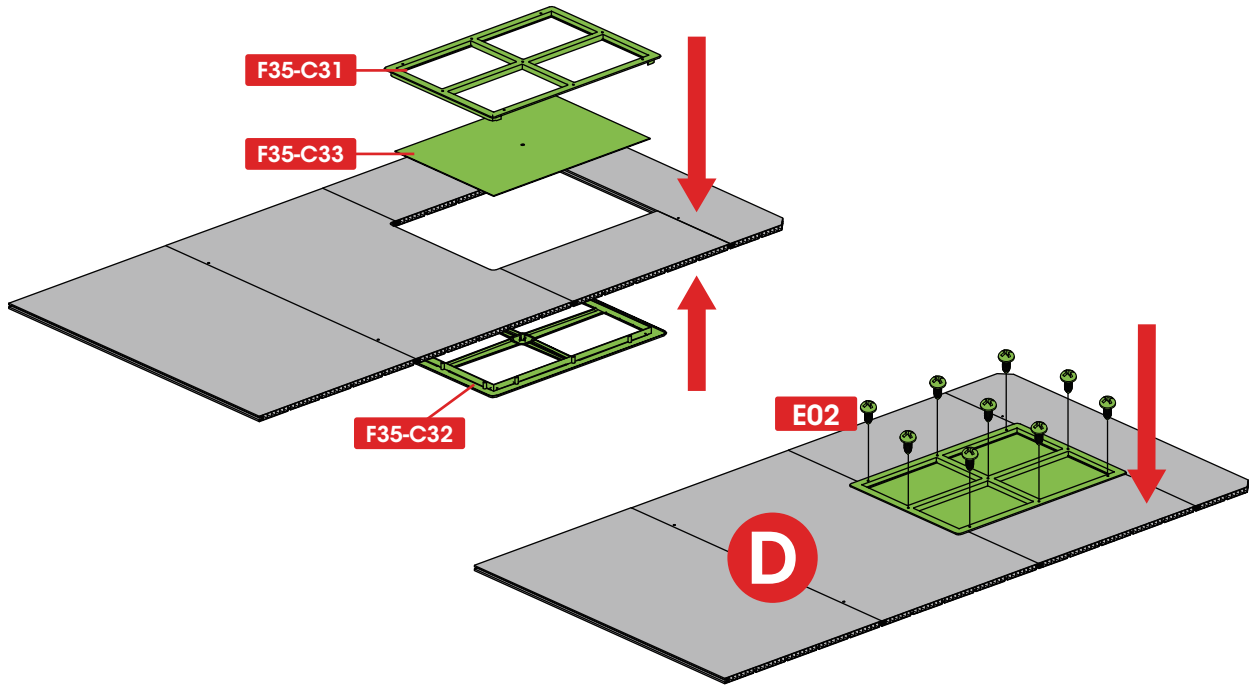

E02 X 9

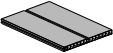
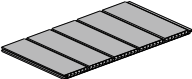

6

 **A64-C06** X 2  **A64-C07** X 6  **E02** X 12

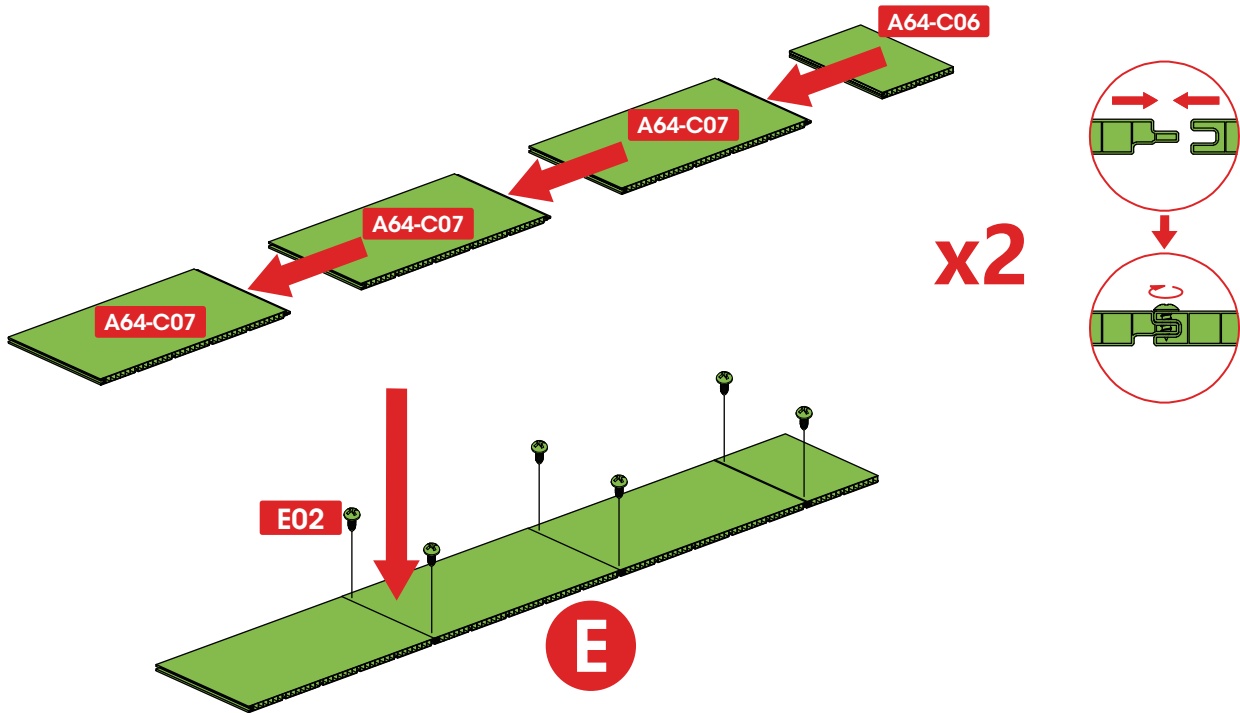

7

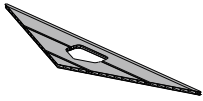

A64-C13 X 2

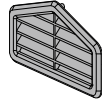

A64-C32 X 2

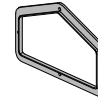

A64-C33 X 2



E02 X 8

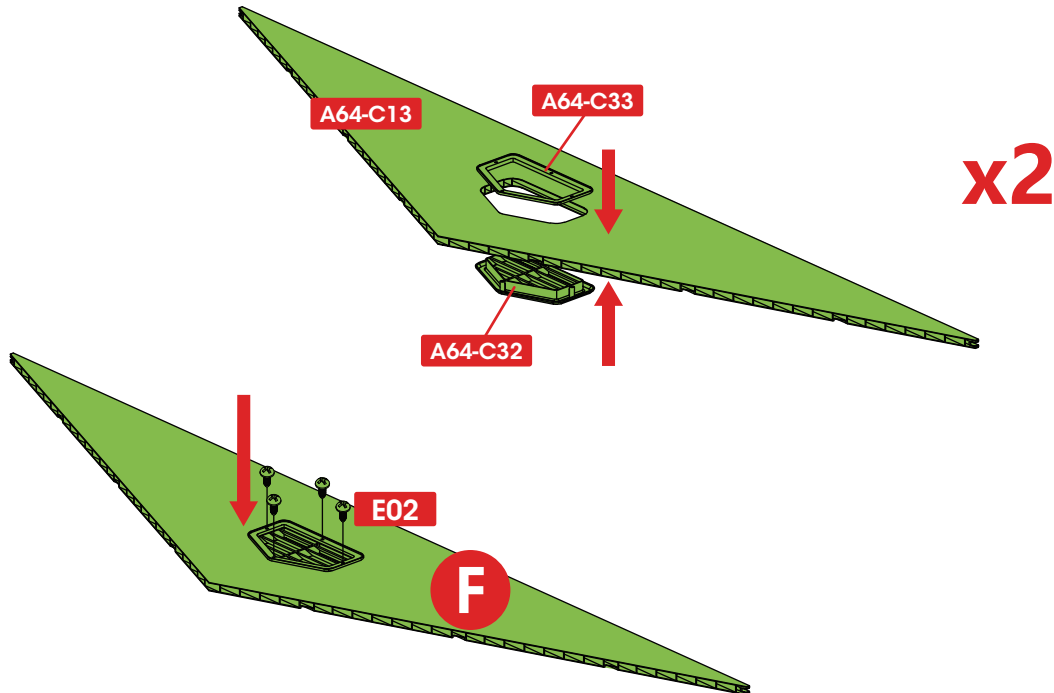

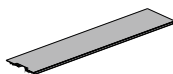

A64-C14 X 2

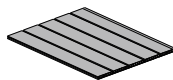

A64-V4-C01 X 4

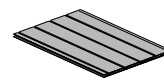

A64-V4-C02 X 4



A64-V4-A03 X 4



E02 X 32

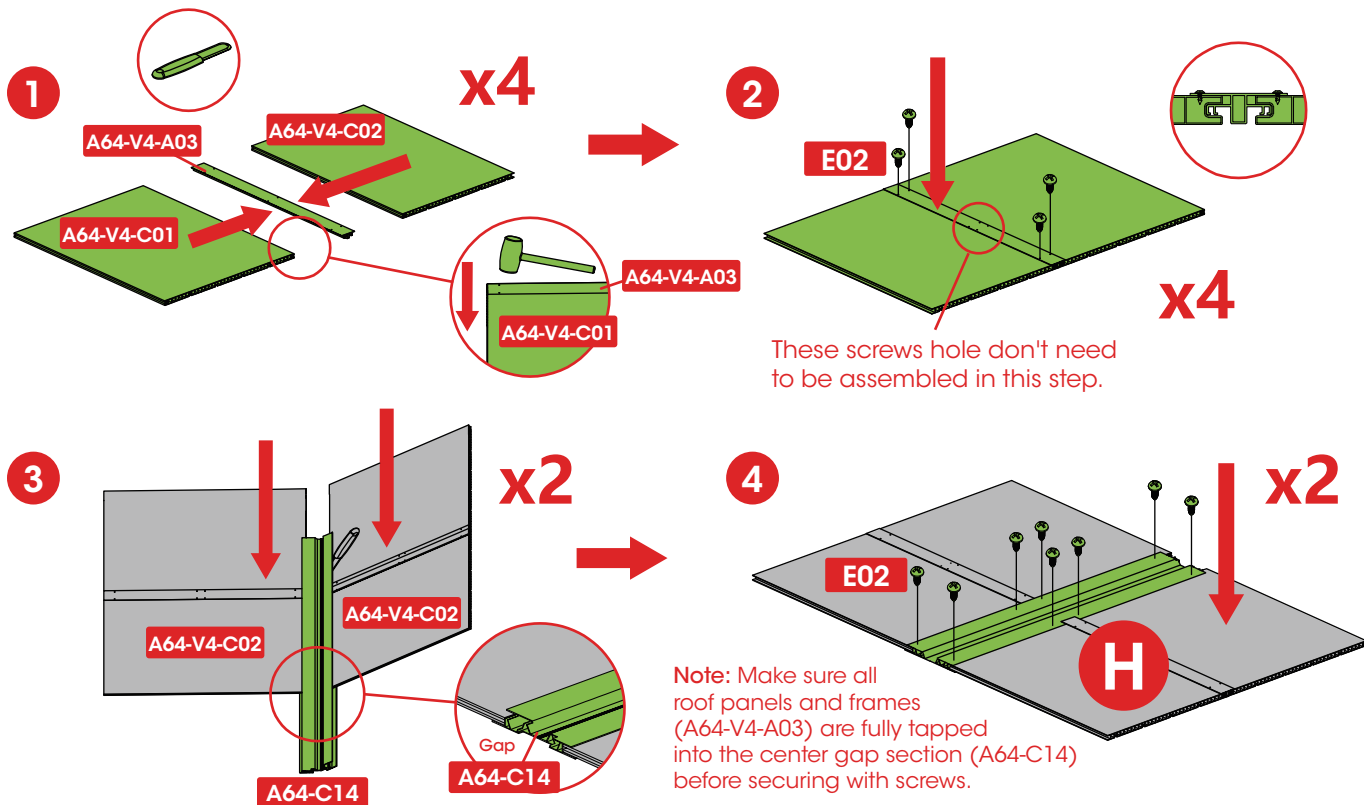

9



Note: When you assemble door of the next step, please kindly confirm the diagonal distance "X" of the door should be same before assembling the screws.

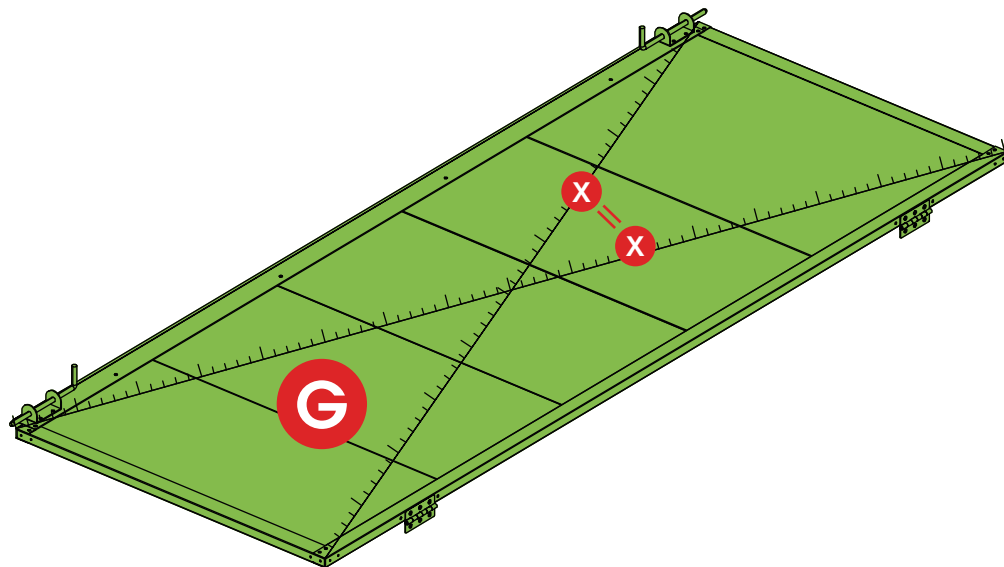

10



A64-C04 X 4

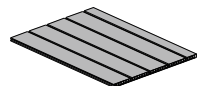

A64-C05 X 1



A64-A15 X 2



A64-A02 X 1



A64-A05 X 1



A64-A06 X 2



E02 X 8

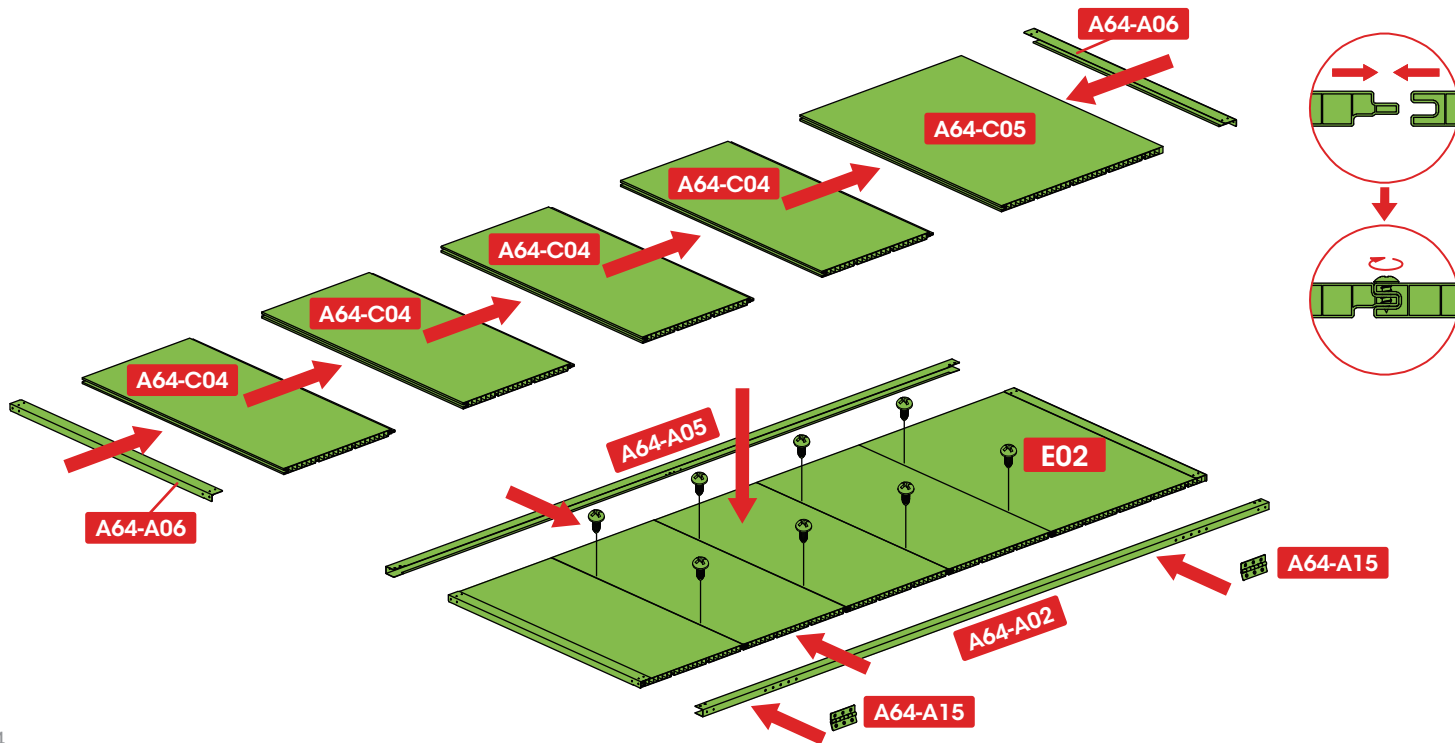

11



F35-C29 X 4



E01 X 16



E02 X 8



E12 X 6

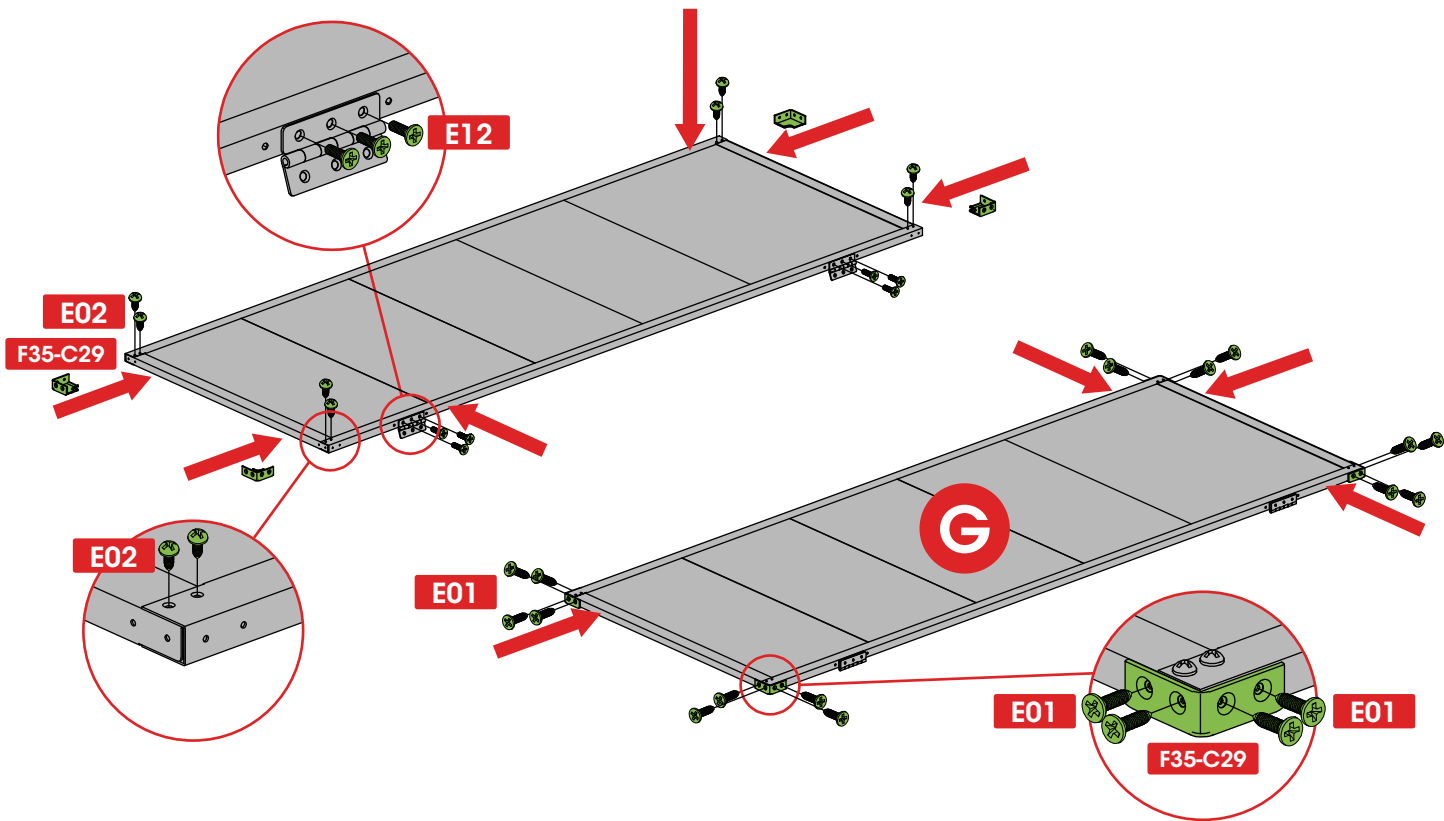

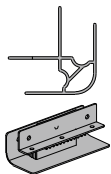
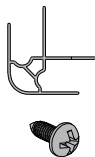
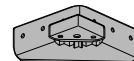
12**A64-C21 X 4****A64-C30 X 2****A64-C22 X 2****E02 X 17****F35-C27 X 4**

Please use rubber-knife to helping assembly.

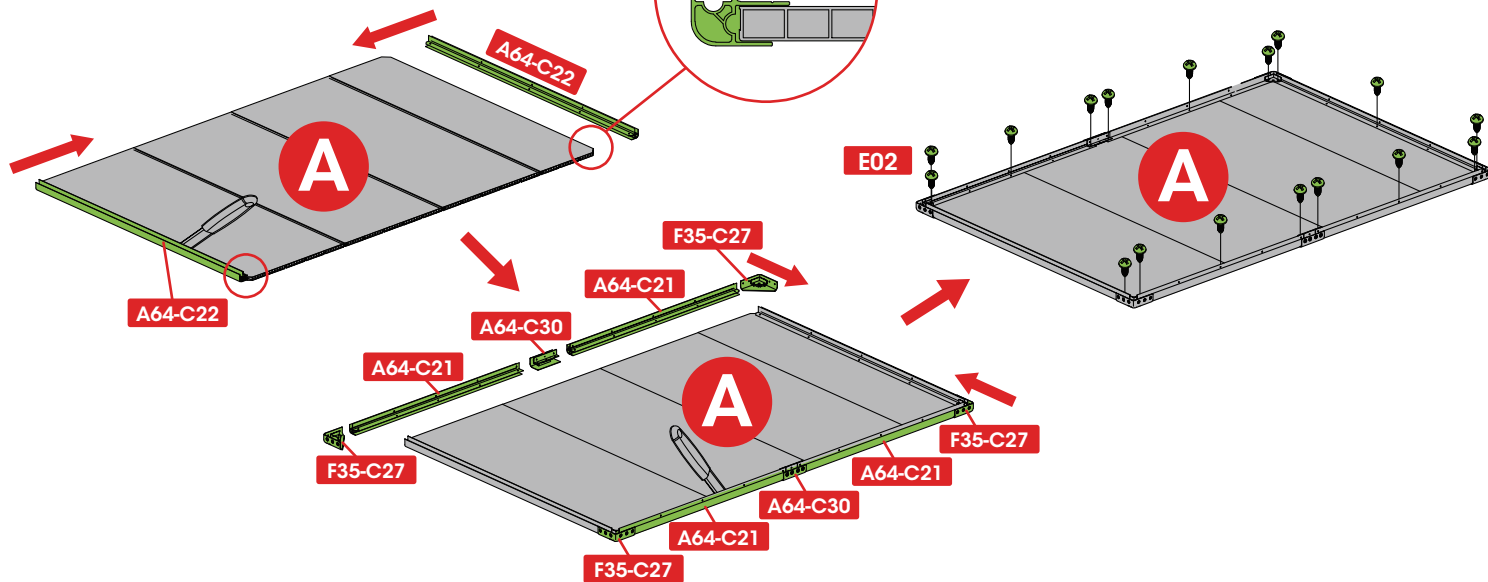
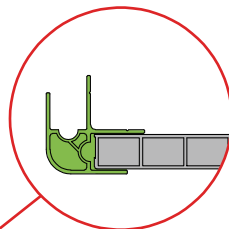

Part 4: Cabinet installation

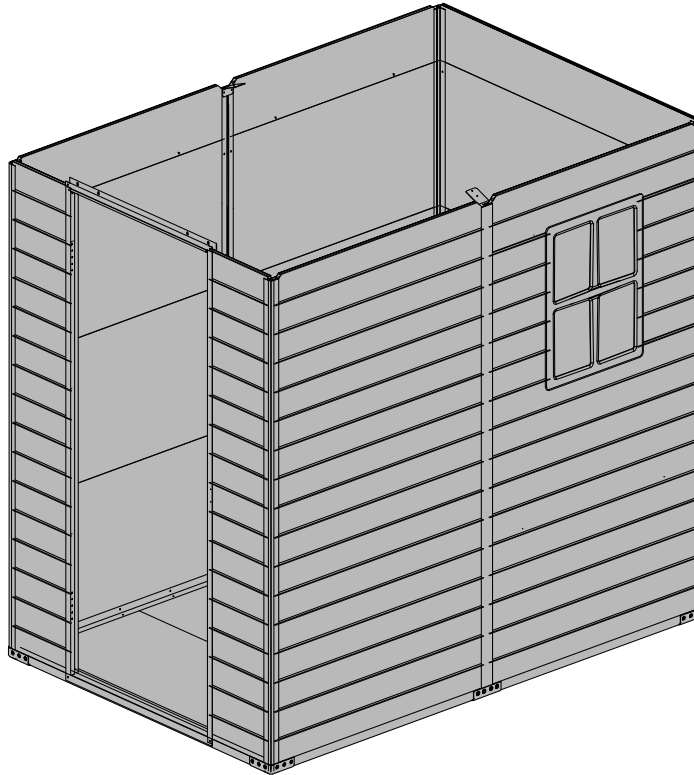

13

 **A64-C19 X 1**  **E02 X 10**



Please use rubber-knife to helping assembly.

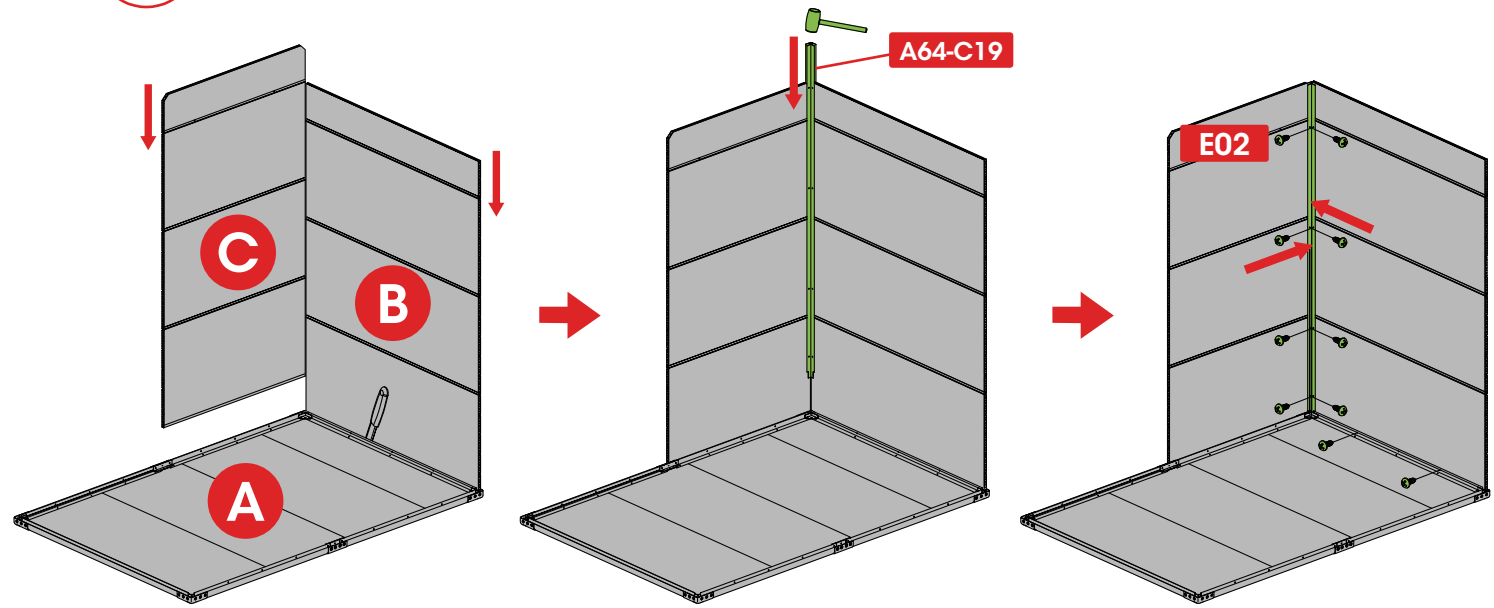

14



A86-V4-C05 X 1



A64-C19 X 1



E02 X 12



Please use rubber-knife to helping assembly.

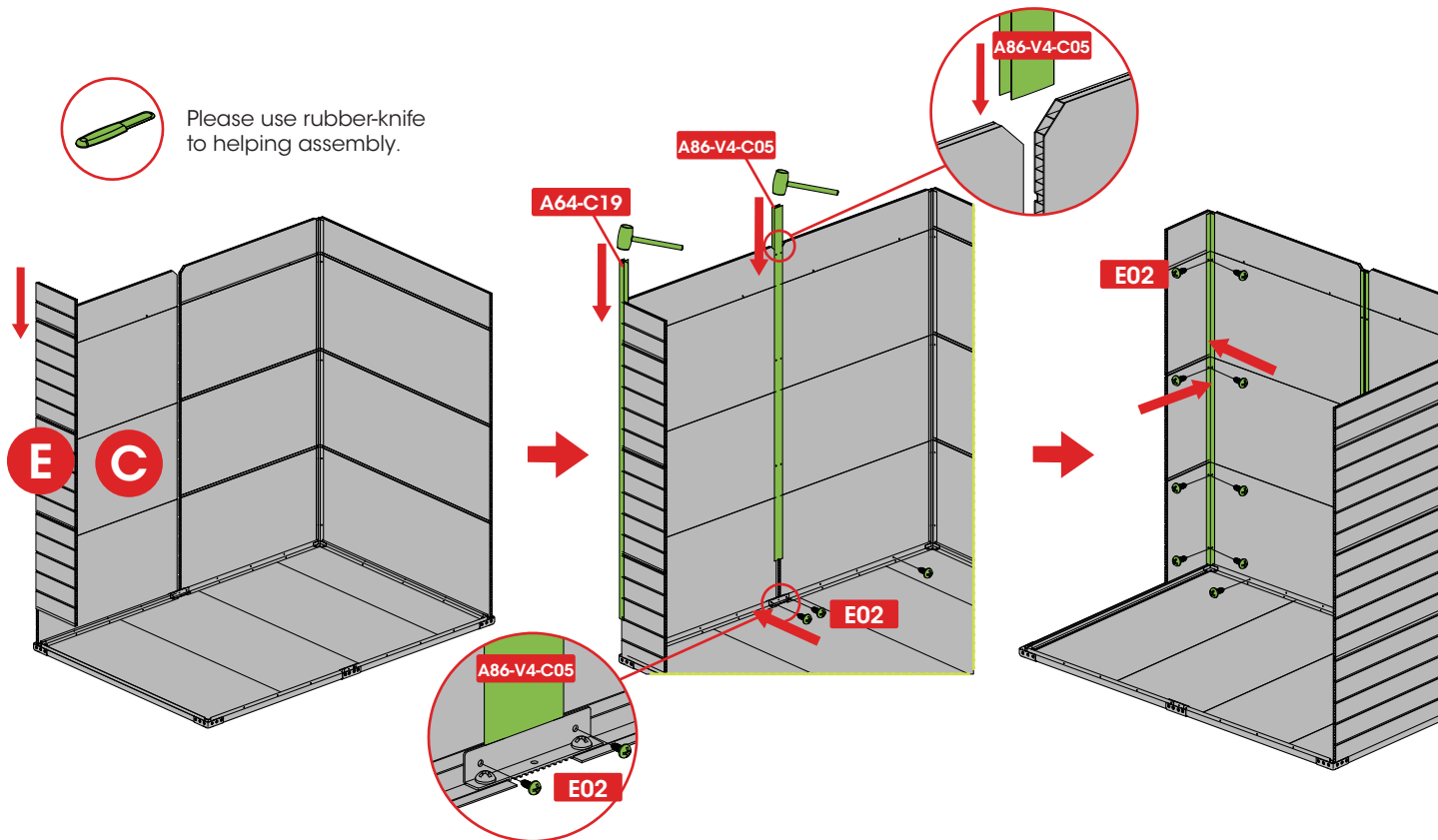

15



A64-C19 X 1



E02 X 9



Please use rubber-knife to helping assembly.

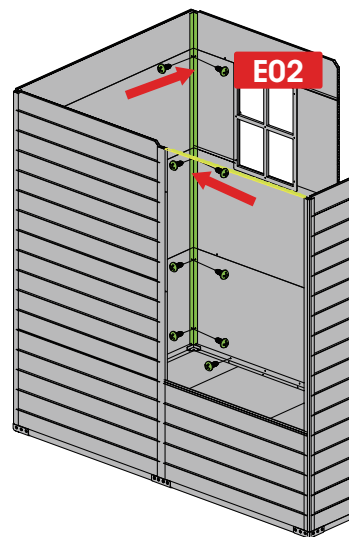
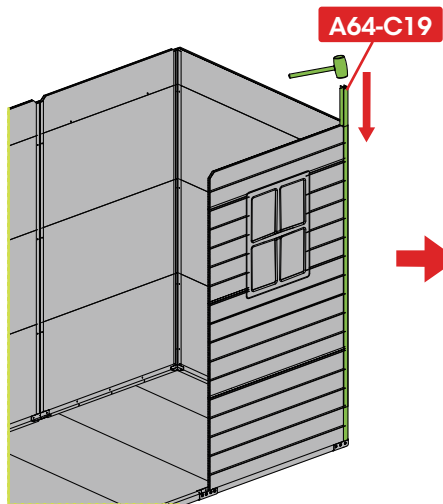
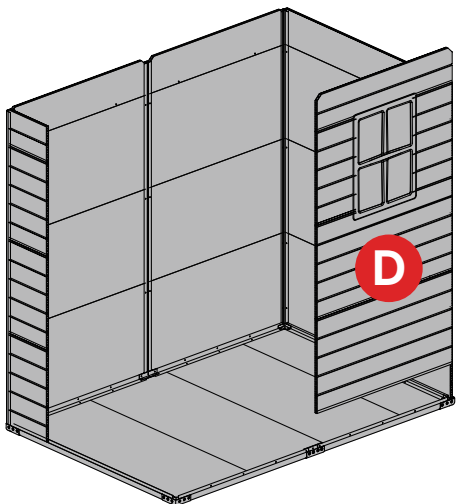

16

 **A86-V4-C05 X 1**  **A64-C19 X 1**  **E02 X 11**



Please use rubber-knife to helping assembly.

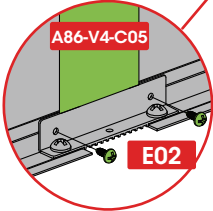
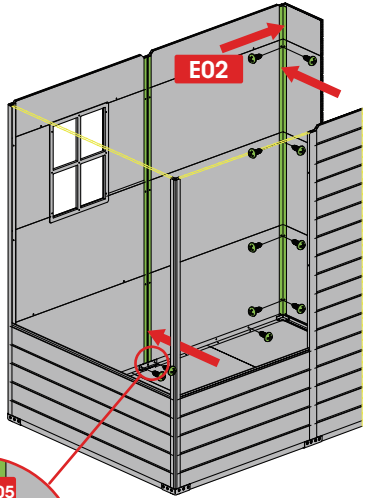
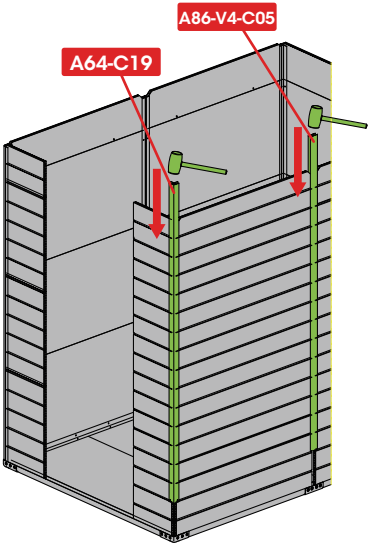
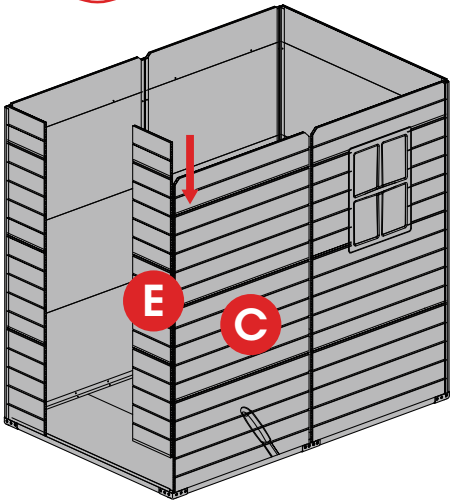

17



A86-V4-A07 X 2



E02 X 28

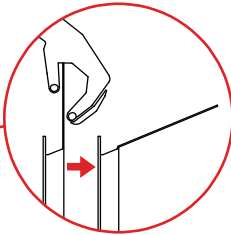

Bend A86-V4-A07 to the appropriate angle by hand.

x2

A86-V4-A07

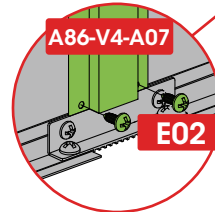
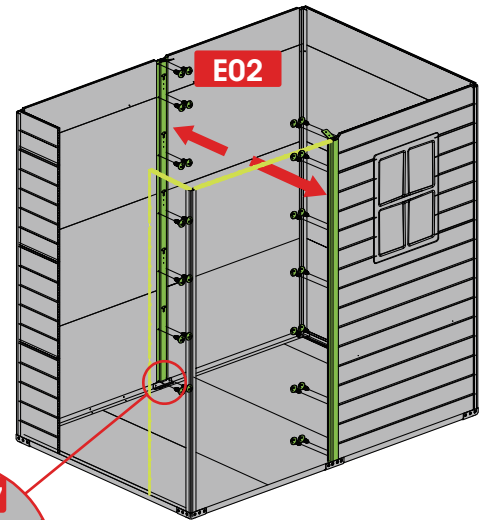
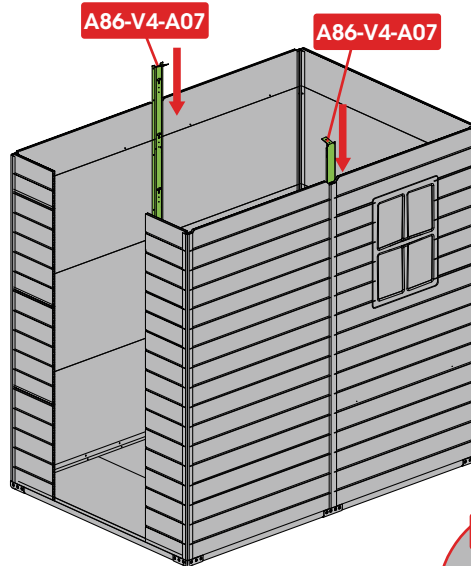

18



A64-V4-A02 X 1



E02 X 5

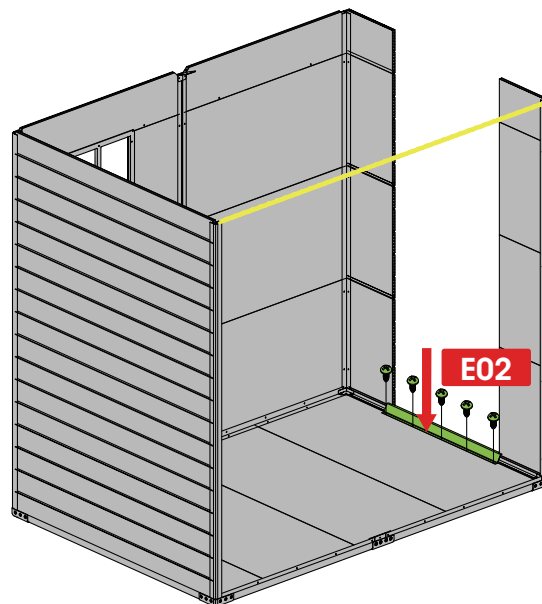
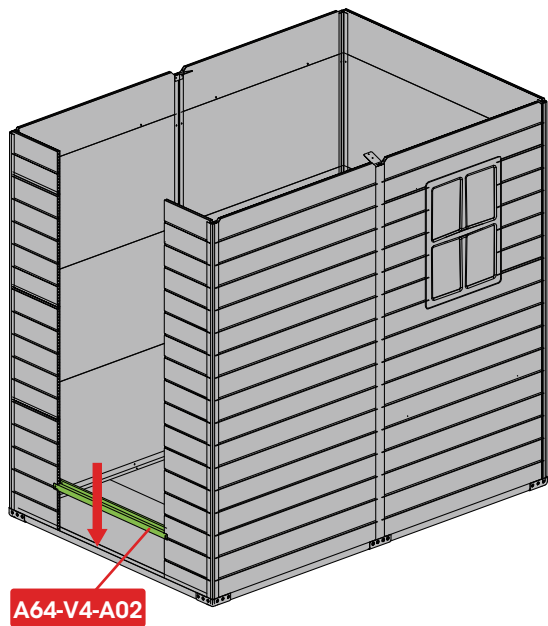

19

 **A86-V4-A01 X 1**  **A64-V4-A01 X 1**  **E02 X 14**

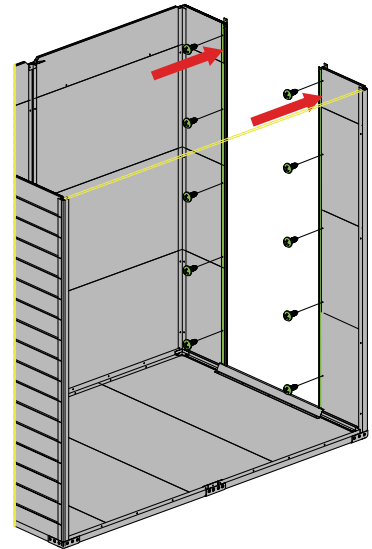
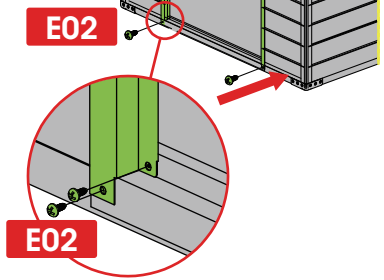
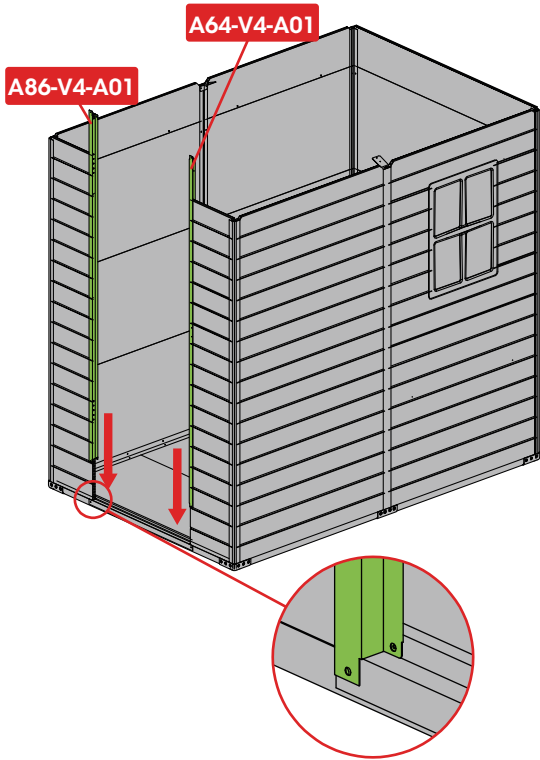

20



A64-V4-A07 X 1



E02 X 8

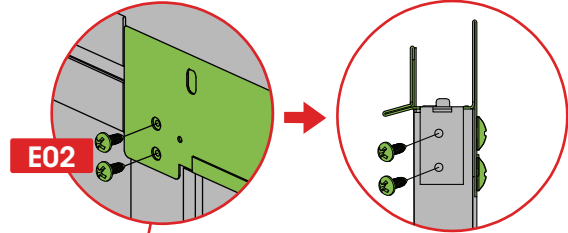
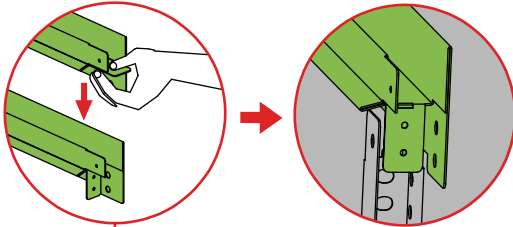

A64-V4-A07

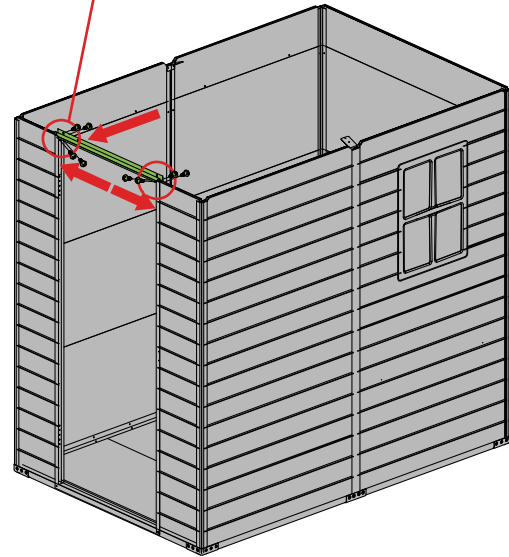
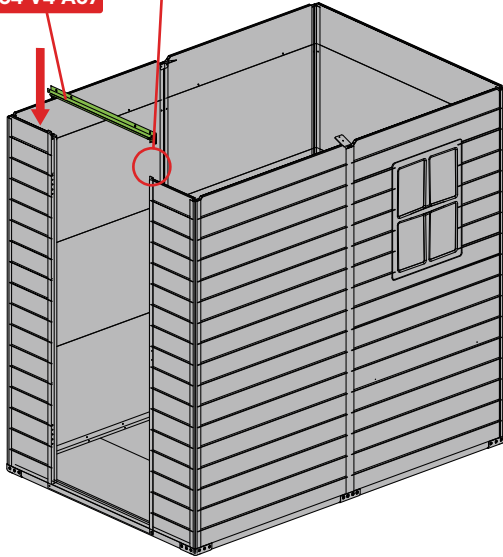

Part 5:

Roof installation and internal fixing

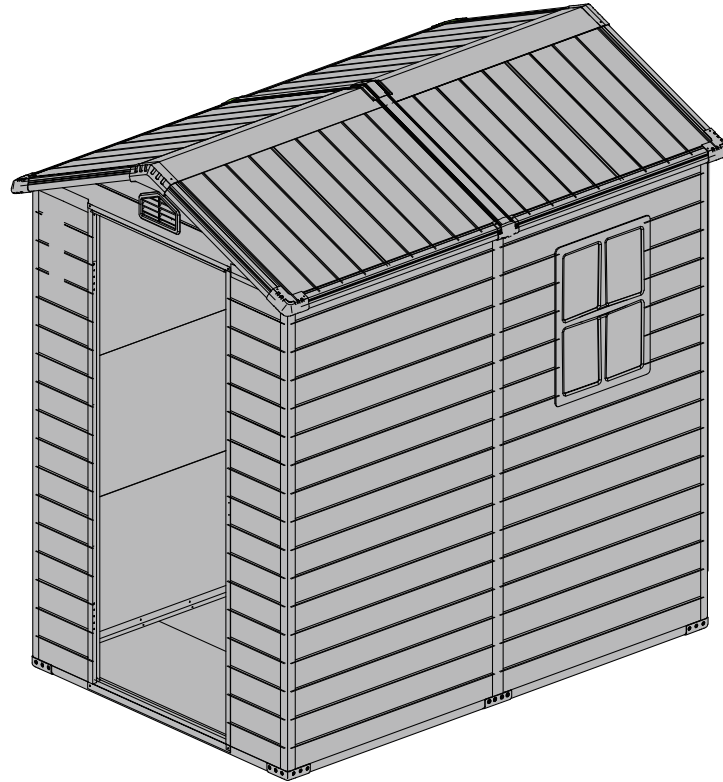

21

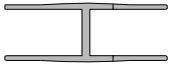

A64-C26 X 1

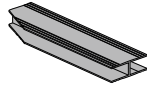

A64-C27 X 2



Please use rubber-knife to helping assembly.

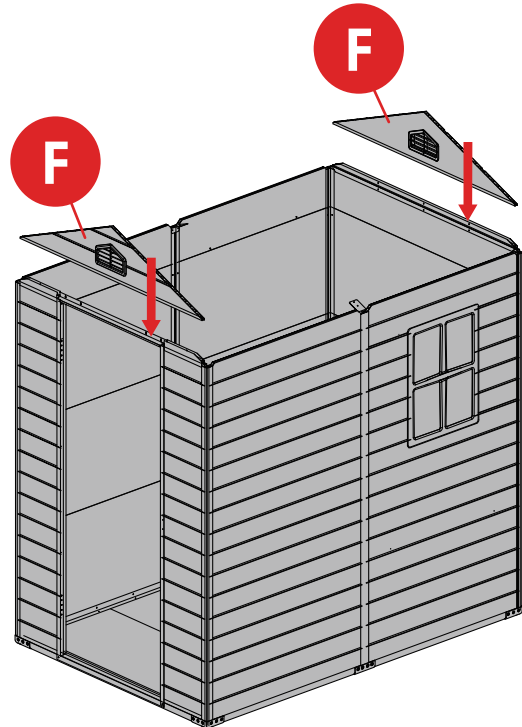
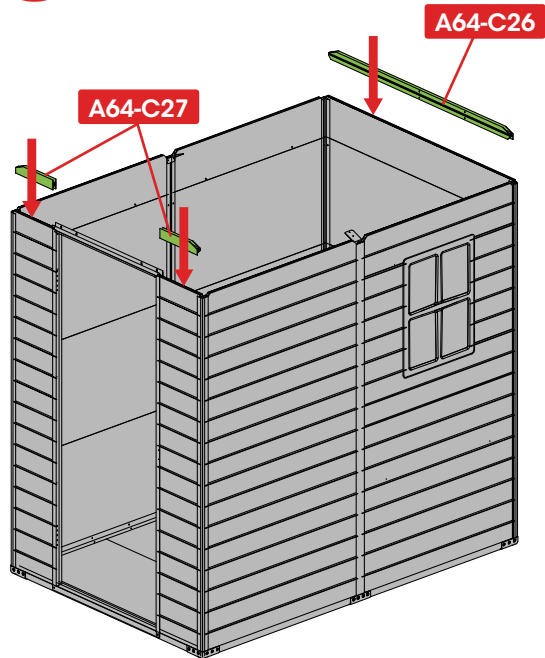

22



E02 X 12

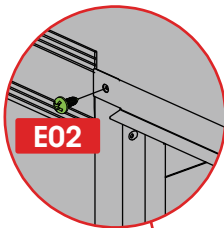

E02

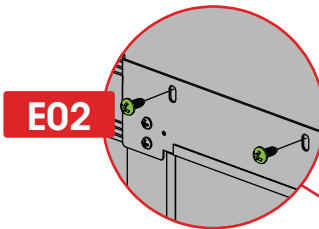
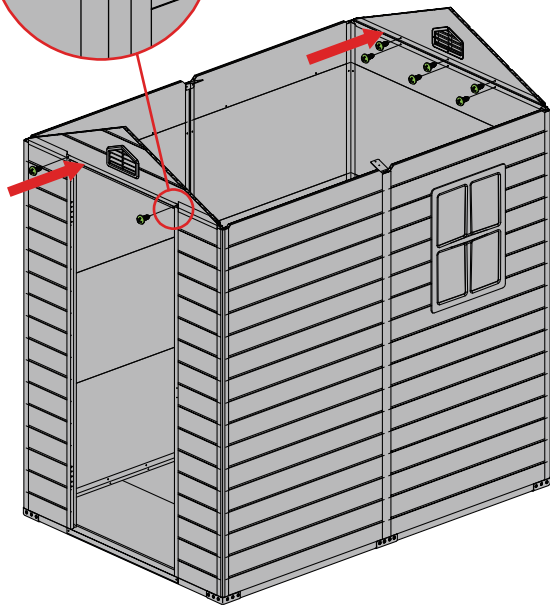

E02

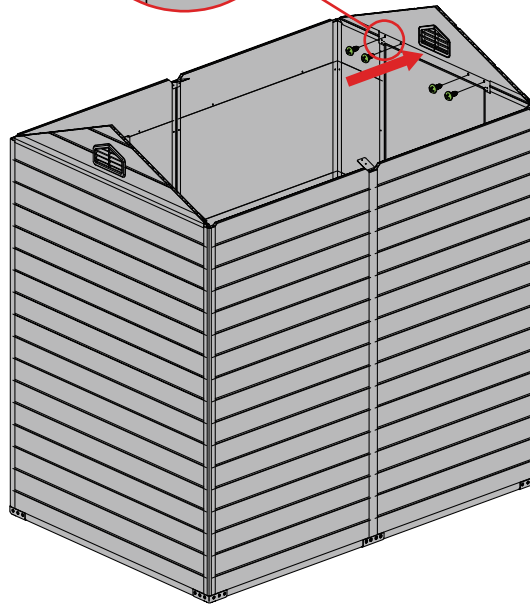

23



A64-C17 X 4

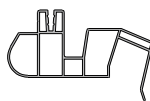

A64-C18 X 4



E02 X 24



Please use rubber-knife to helping assembly.

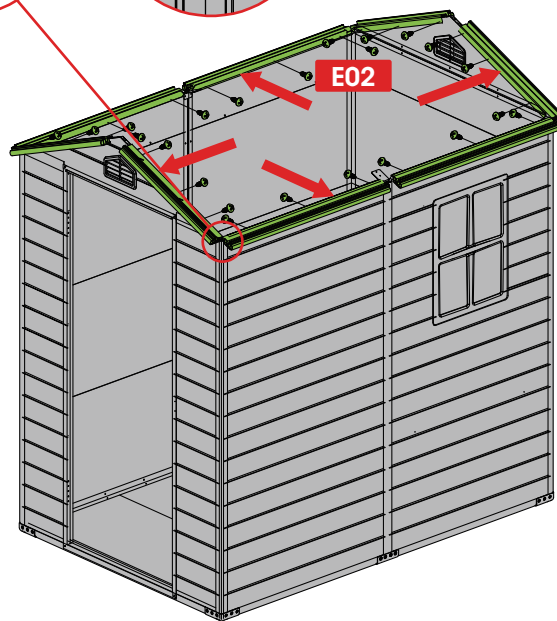
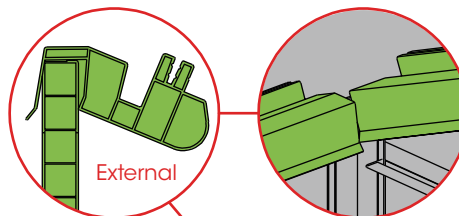
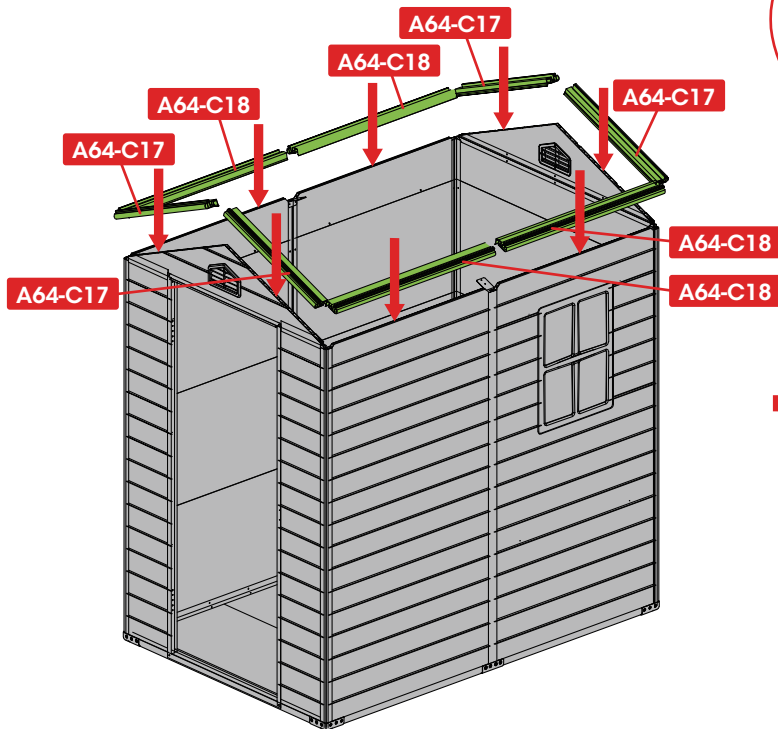

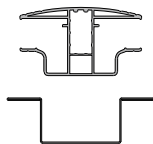

A64-C24 X 2

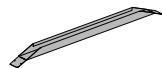

A64-V4-A04 X 2

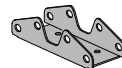

A86-V4-A06 X 1

A64-V4-A05 X 2



E02 X 20

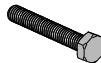

E08 X 4



E09 X 4

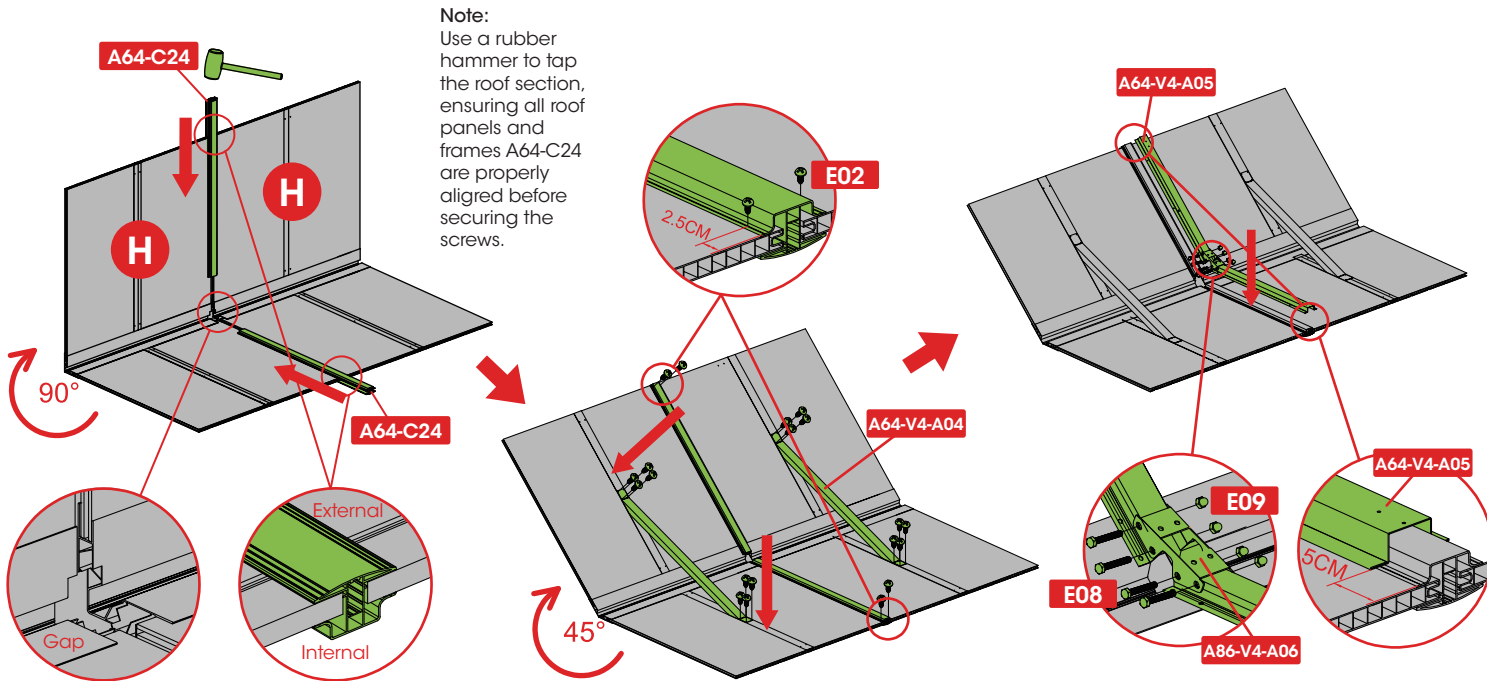

25

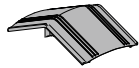

A64-C34 X 1



A64-V4-A06 X 1



E02 X 20



E07 X 4

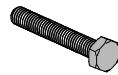

E08 X 2



E09 X 2

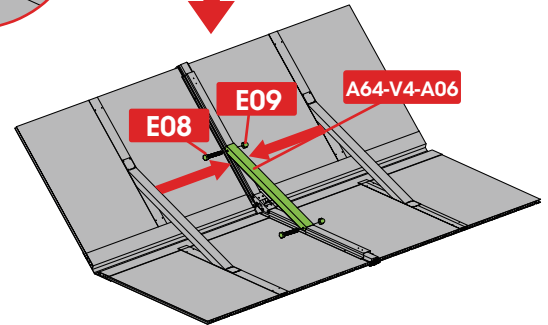
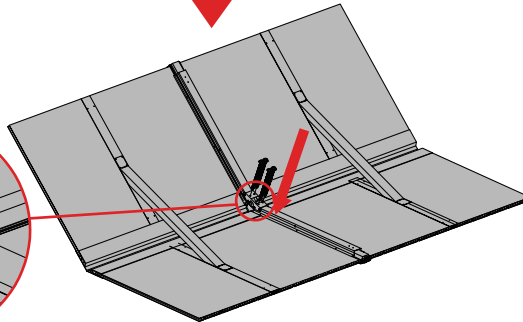
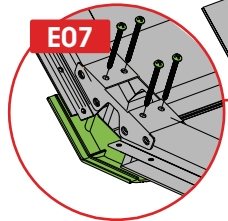
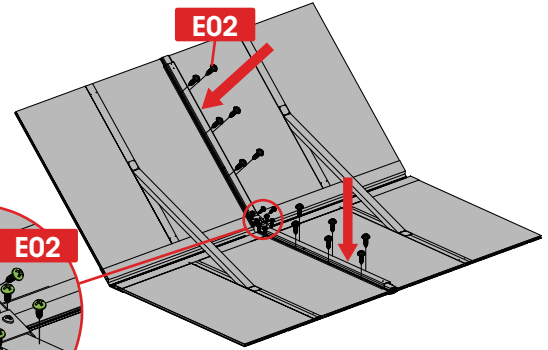
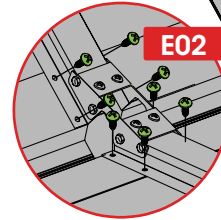
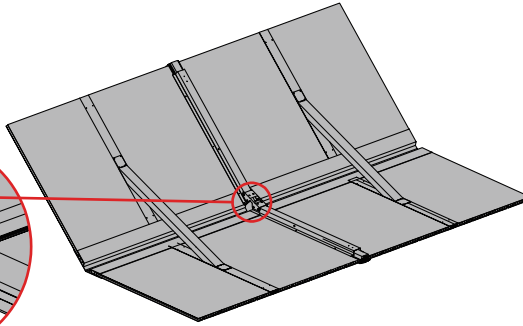
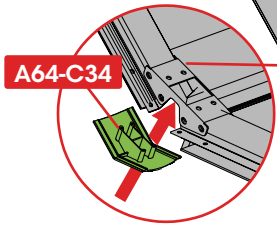

26

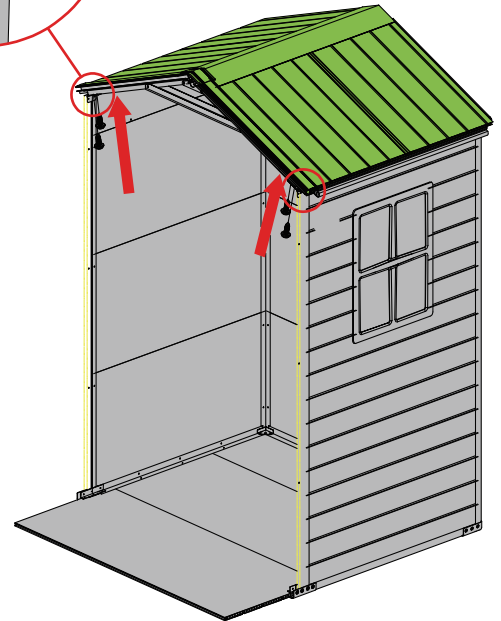
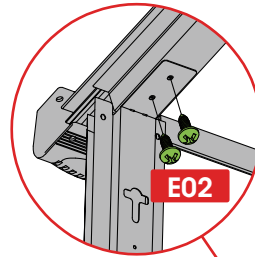
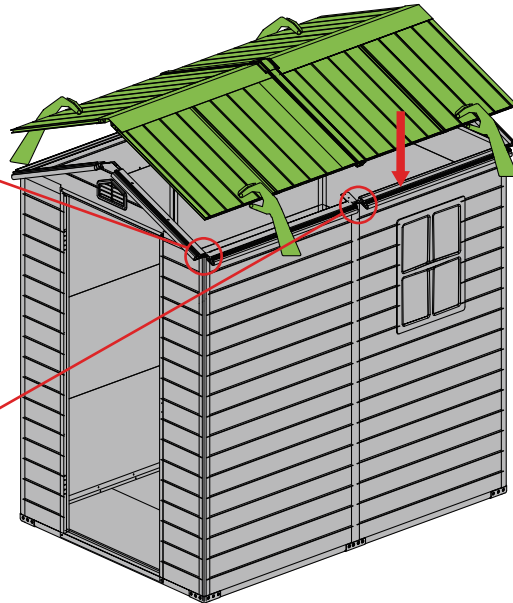
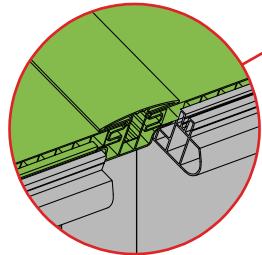
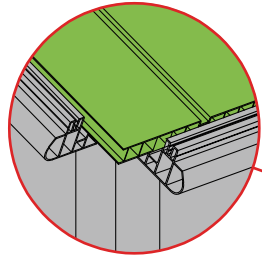

27



A64-C18-1 X 4



A64-C17-1 X 4



E02 X 16

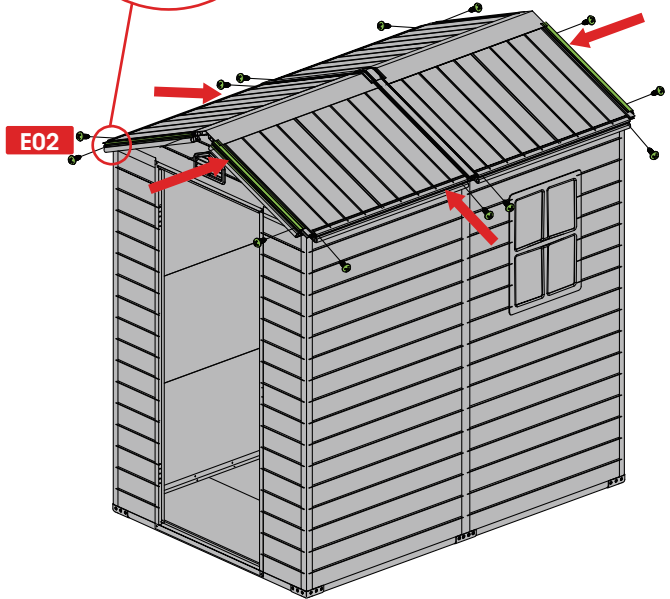
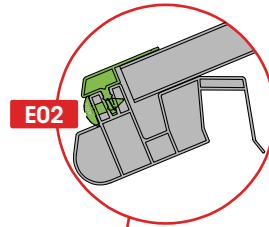
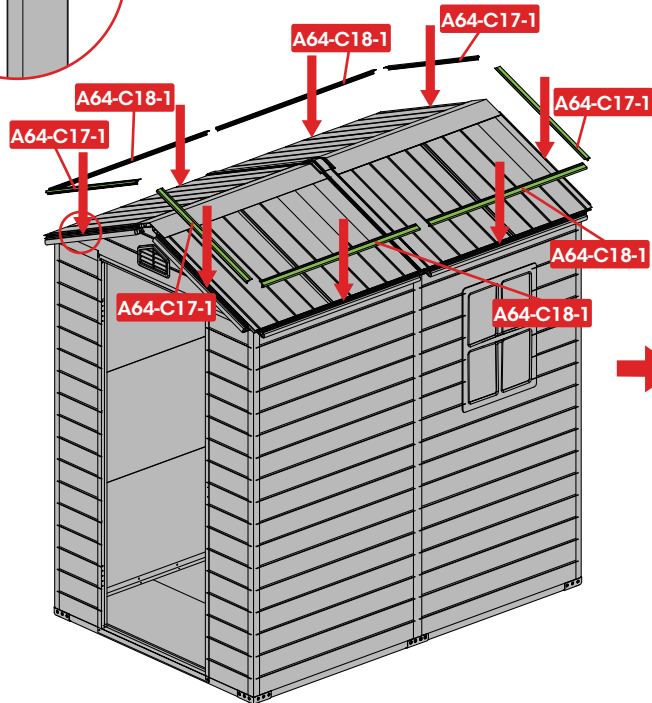
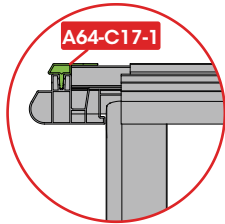



A64-C29 X 2



A64-C31 X 2



F35-C30 X 4



E02 X 32

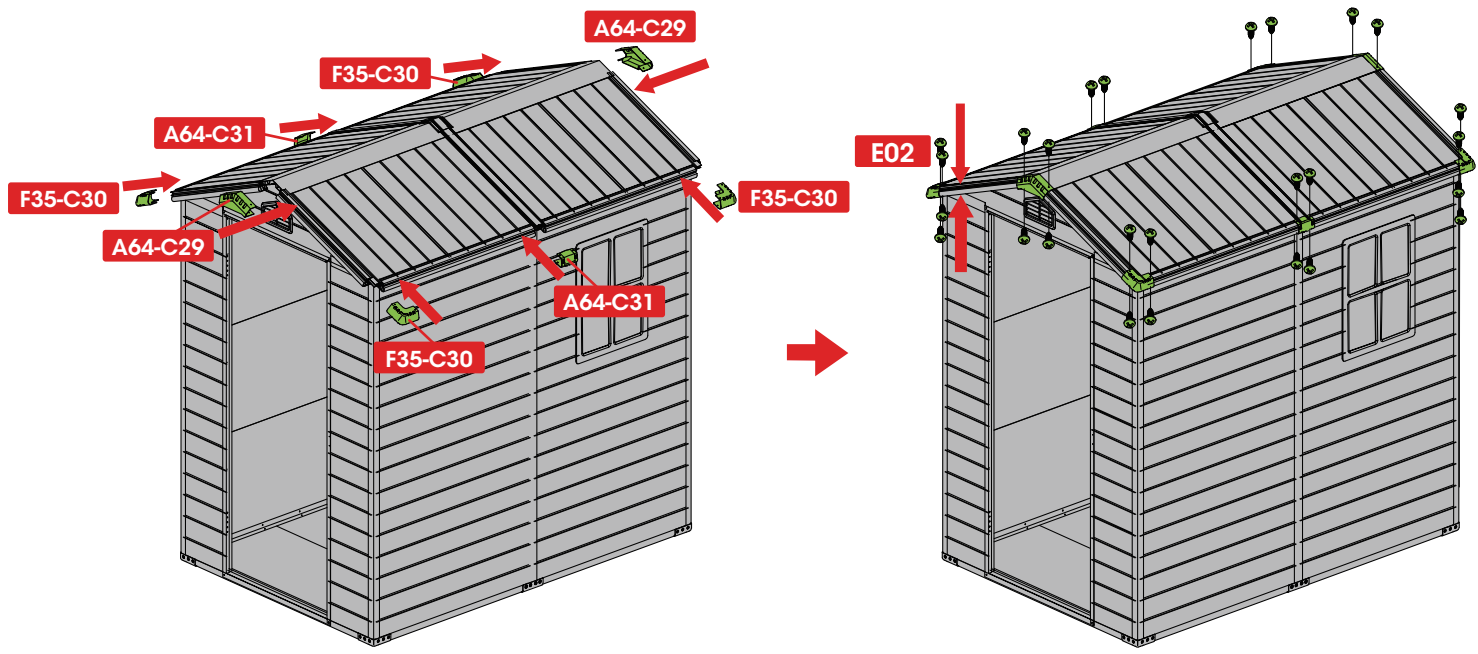

Part 6: Door installation and adjustment

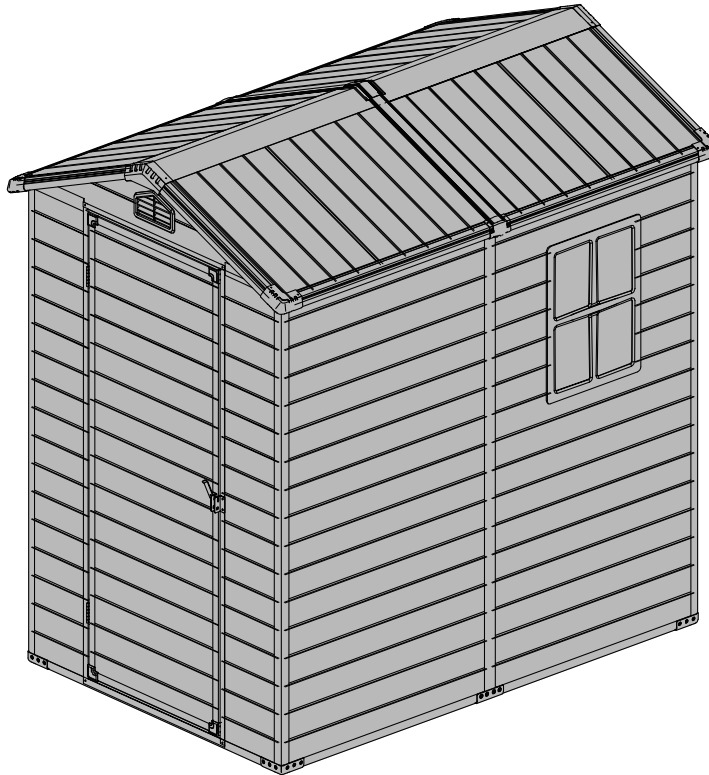

29



E12 X 6

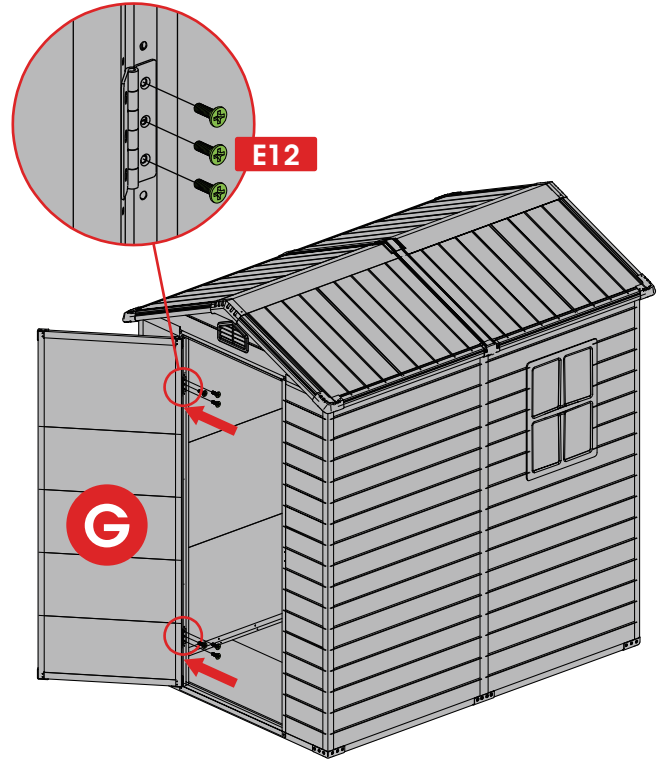
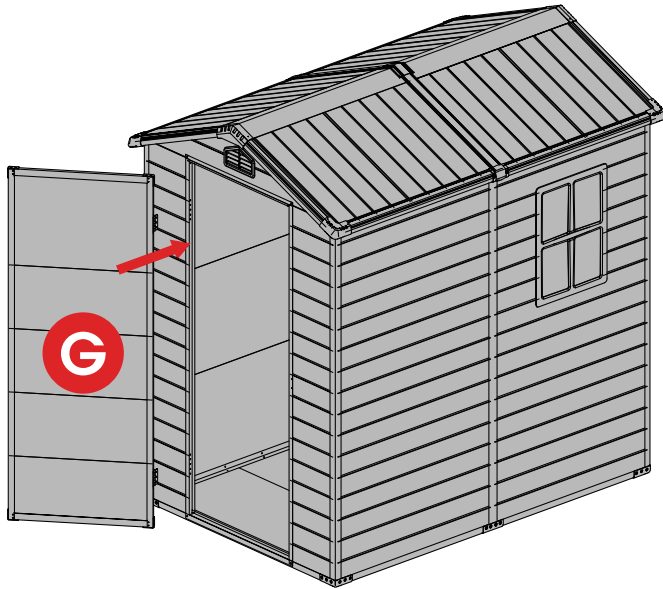

30



D02 X 1



E01 X 4

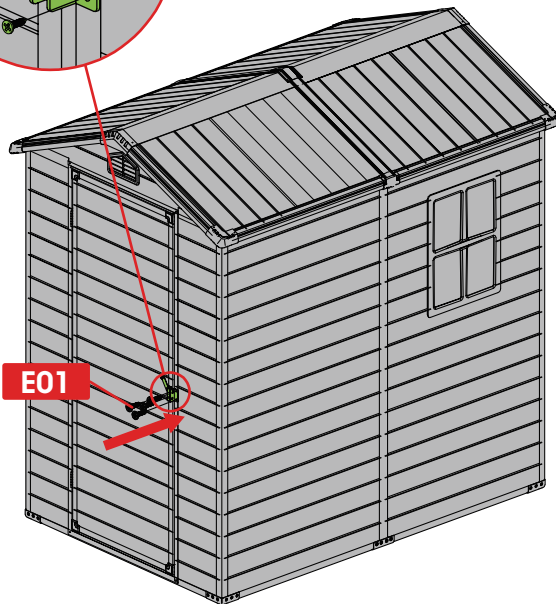
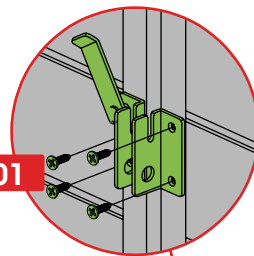
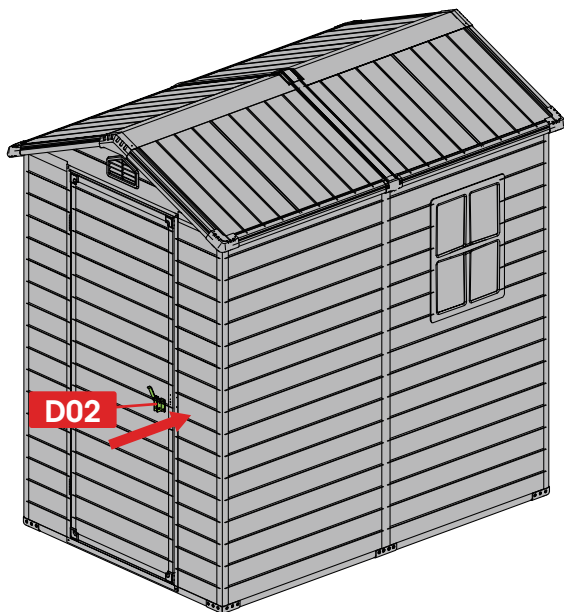

31



E03 X 32

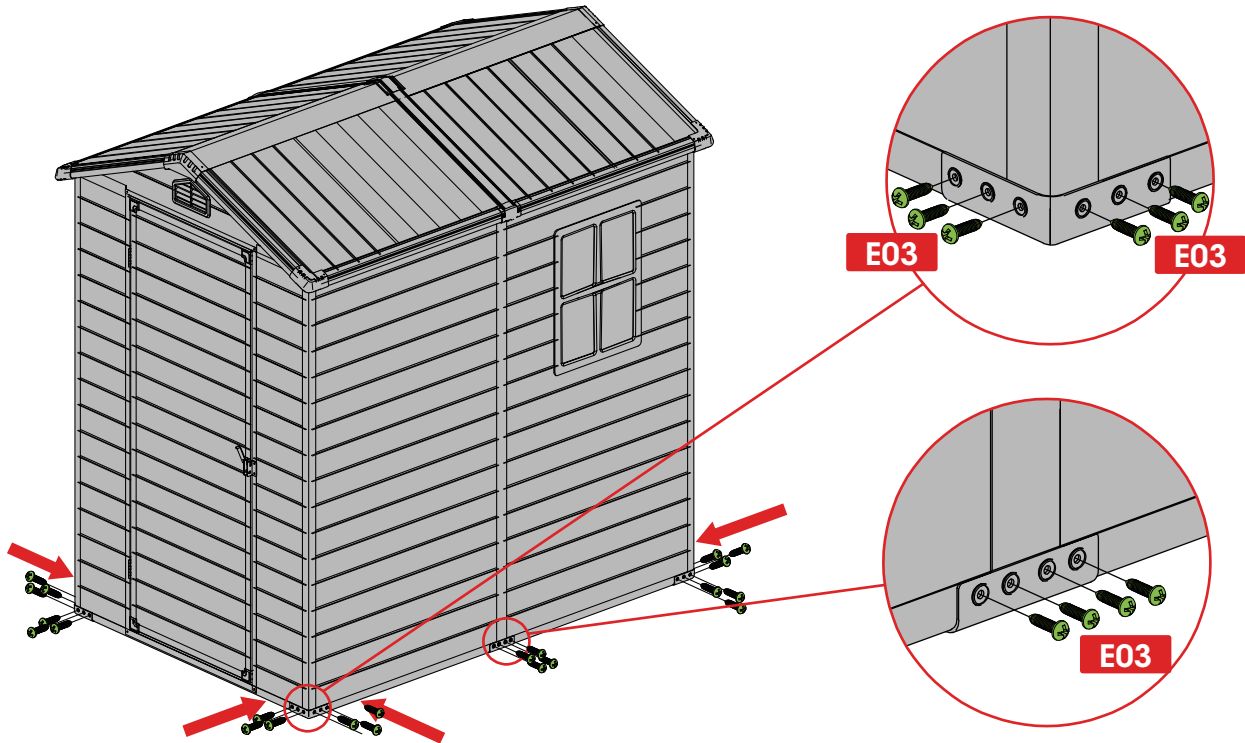

32

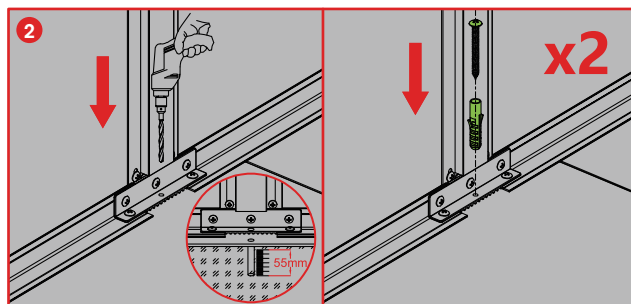
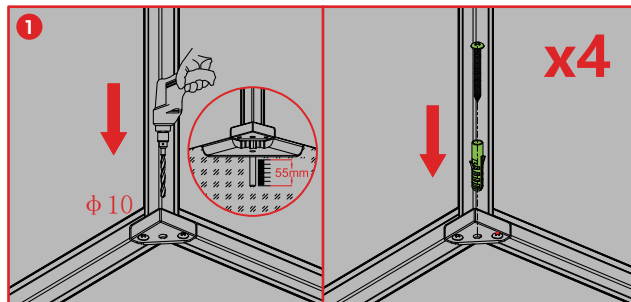
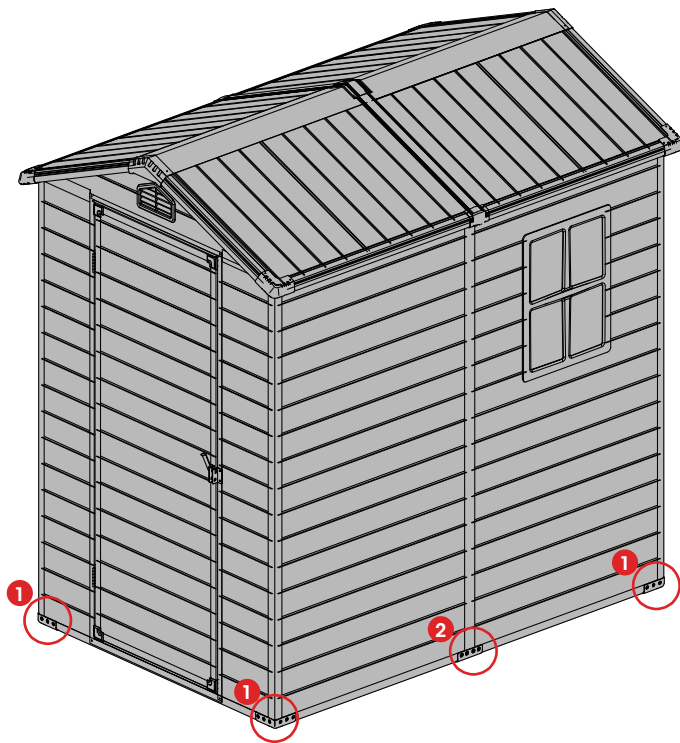
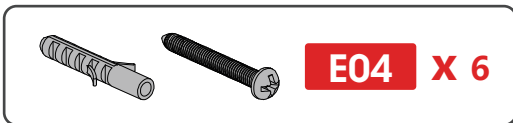

HELP CENTER

Question about your product? We're here to help. Visit us at:

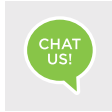

Chat Support



Product Inquiry

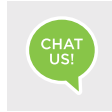

Orders FAQ



Product Assembly



Returns & Refunds

We Stand Behind the Quality of Their Furniture

If you have any issues with your item please let us know! We will always do our best to come up with a solution that you will be happy with. Please get in touch with our customer service team before returning the product. And pls do not throw the original box(es) if you have not finished assembling or confirmed no quality issues.

Length of return period:

Items can be returned within 30 days of purchase.

In the meanwhile, everything you purchased from us comes with a one-year warranty.

Who is responsible for the return shipping fee:

We will cover the return shipping fees if:

1. Your item has a manufacturing defect in its materials or workmanship. For example, torn wicker or misaligned screw holes. We will send you a prepaid shipping label after photos are sent.
2. Your item has been damaged in transit. For example, glass is broken or wicker is damaged. We will send you a prepaid shipping label after photos are sent.
3. You receive the wrong box(es) due to a warehouse error. We will send you a prepaid shipping label after photos are sent of the wrong SKU numbers on the outer box(es).
4. One or more boxes are lost in transit. We will send you a prepaid shipping label if you no longer want the item.

*However, we still hope to work with you for a better solution instead of a return. Please don't hesitate to contact our customer service team.

Customer will cover the return shipping fees if:

1. You don't like the product(s) after receiving the box(es).
2. You no longer need the product(s) but you have received the box(es).
3. You buy the product(s) by mistake but you have received the box(es).
4. Order/shipment cancellation failed and you have received the box(es).

Return Request

In order to get a full refund as described in this return policy, all items must be: (1) In a brandnew/unused condition, please provide photos before and after packaging. (2) When returning, all accessories and parts are firmly packed in all original packaging.

If your return does not meet the requirements, you may not get a full refund.

When will I be refunded?

The refund is released once the goods have been returned to our warehouse.

What if the product is damaged/defective outside of the valid return period?

We want you to be a happy customer. Please reach out to us by email and we will come up with a solution to make sure you are satisfied.

Reach us at



service@kmcglobe-us.com



(only us) +1 213-816-4788