









# ASSEMBLY INSTRUCTION

## DESCRIPTION:TWIN BED WITH TRUNDLES







Caution: Please read instructions thoroughly before unpacking assembly parts. Sharp, exposed staple tips can cause injury. Therefore, for your protection, please remove any exposed staple used in packing.

1. Two people are required to safely assemble this product.
2. Be sure to check all hardware in case that small parts may come loose inside the carton during shipment.
3. Please do not over tighten screws or bolts.
4. Please unpack the box and place the contents on a flat, level and soft surface.

### HARDWARE LISTS

NO:	DESCR IPTION	SKETCH	Q"TY	NO:	DESCR IPTION	SKETCH	Q"TY
A	ALLEN KEY		1	G	JCBC BOLT $\varnothing\frac{1}{4}$ "*1-1/4"		4
B	JCBC BOLT $\varnothing\frac{1}{4}$ "*3-1/8"		8	H	wood nog $\varnothing 8$ *L30mm		8
C	SPRING WASHER $\varnothing\frac{1}{4}$ "		12				
D	FLAT WASHER $\varnothing\frac{1}{4}$ "		12				
E	UWASHER $\varnothing\frac{1}{4}$ "		8				
F	SCREWS $\varnothing 8$ * $\varnothing 4$ *L25mm		48				

### PART LIST

NO:	DESCR IPTION	SKETCH	Q"TY	NO:	DESCR IPTION	SKETCH	Q"TY
(1)	HEADBOARD PANEL		1	(6)	FRUNDLE SIDE PANEL		2
(2)	FOOTBOARD PANEL		1				
(3)	SLAT(12)		2				
(4)	SIDE RAIL		2				
(5)	FRUNDLE FRONT PANEL		2				

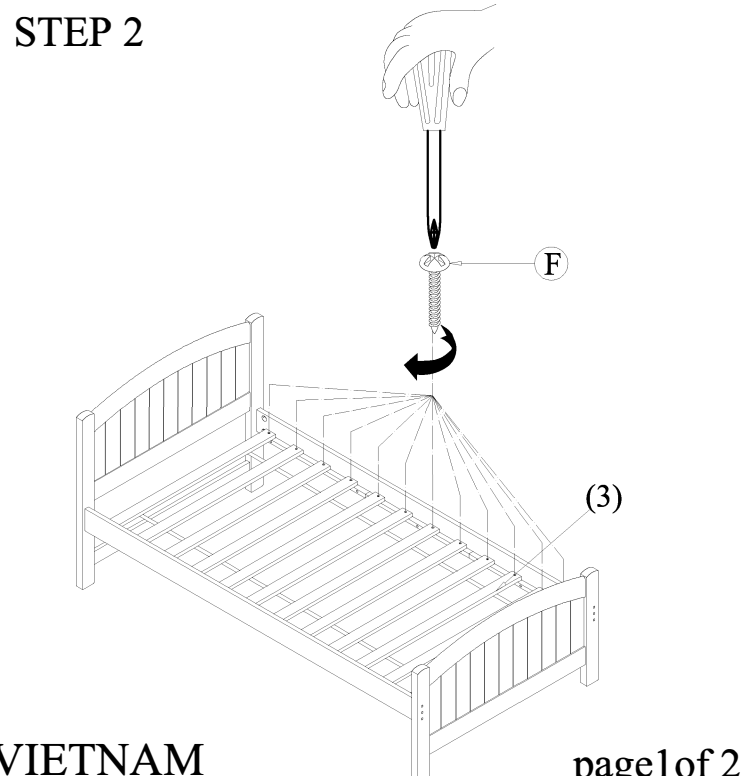
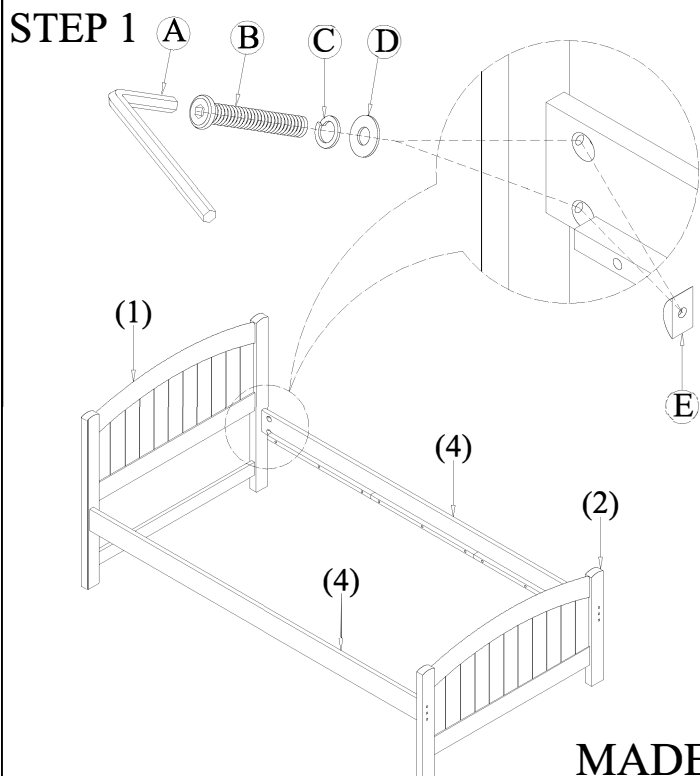
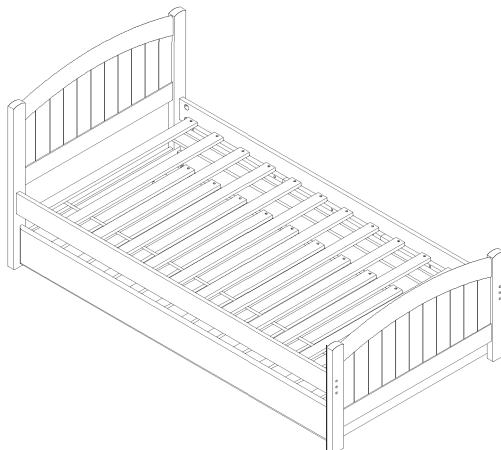

STEP 3

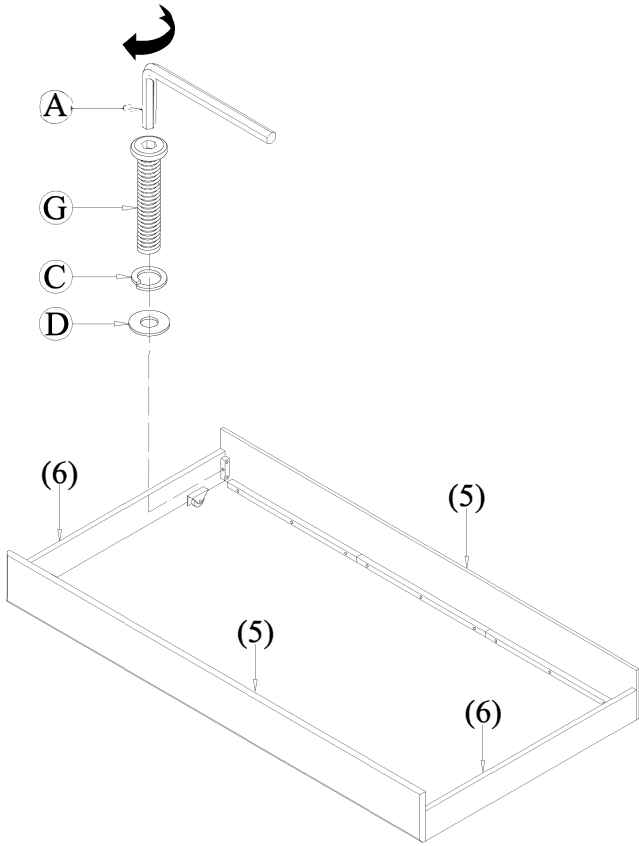

STEP 4

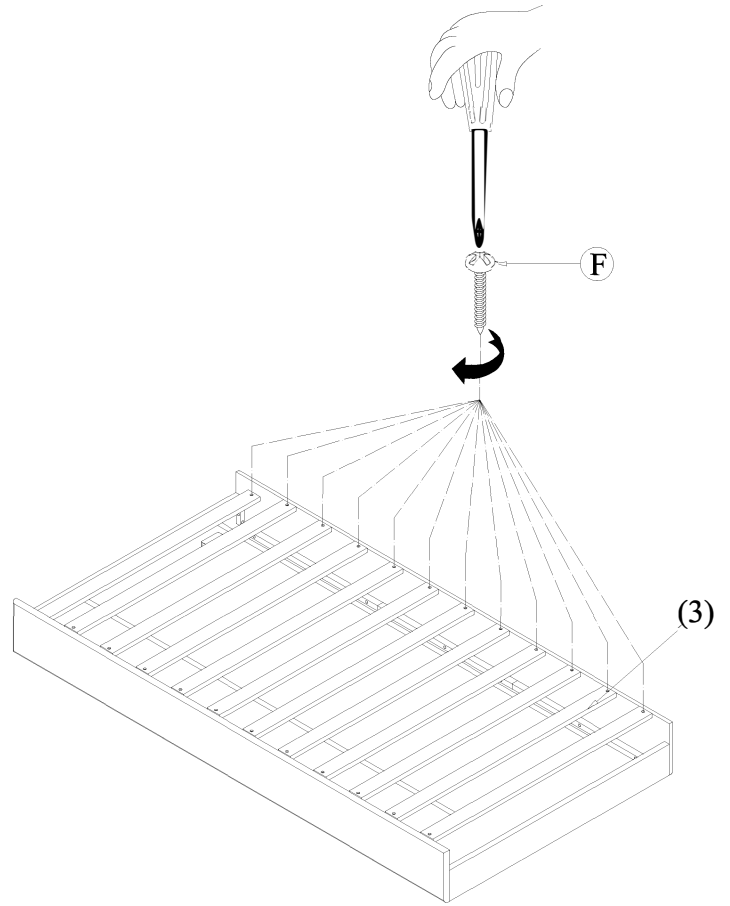

STEP 5

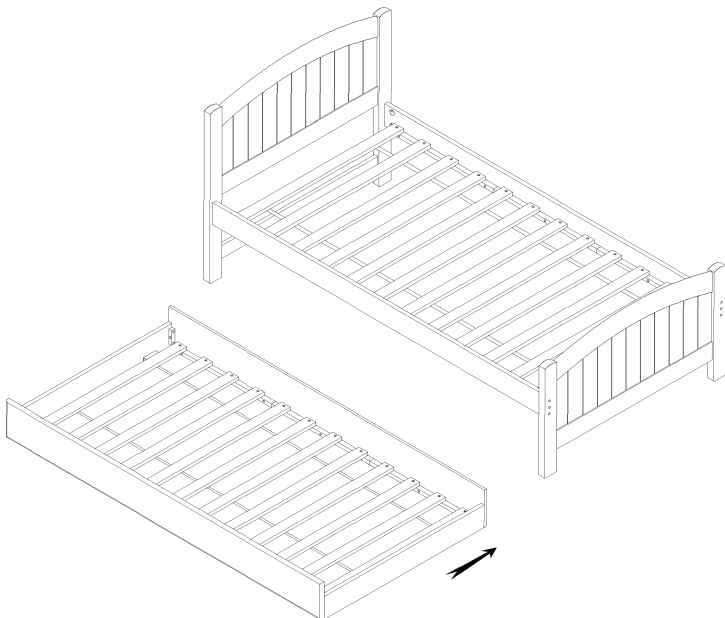

STEP 6

