

VINGLI 120 Gal Installation Instruction

Note: Before inserting panels to holes, make sure parts are aligned. If you want to use a hammer to make it, please put cloth or pad below in case of any damages.

Parts List

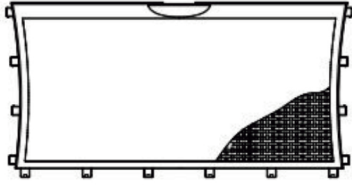

A: Front Panel x 1

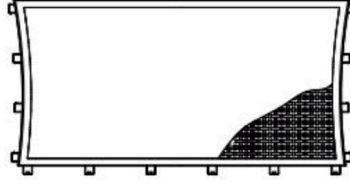

B: Back Panel x 1

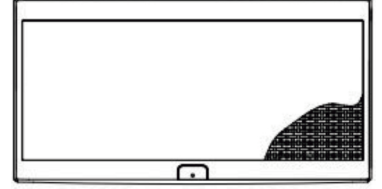

C: Top Lid x 1

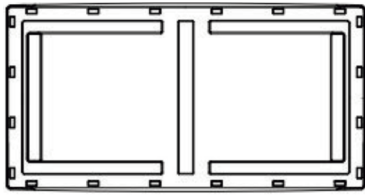

D: Bottom Panel x 1



E: Side Panels x 2

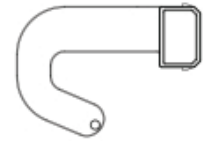

F: Hooks x 4

Whole View

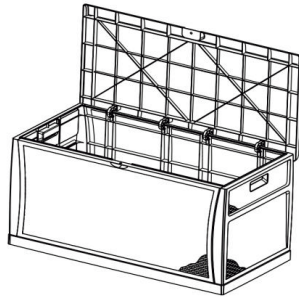

Parts Details

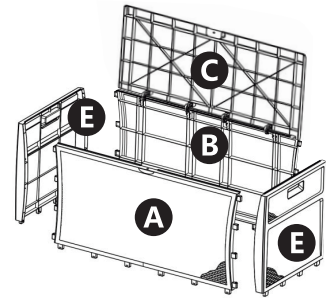

Step 1

Fix the front, back and side panels

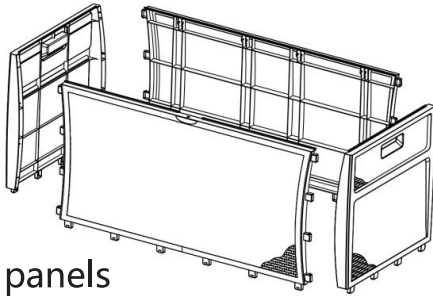

Step 2

Fix the front, back and side panels to the bottom panel

Note: Put the flat face upwards

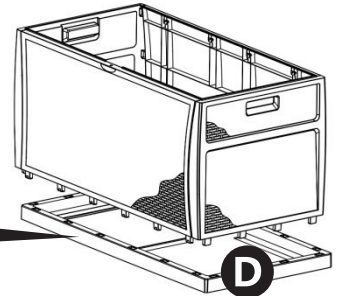

Step 3 Fix the lid to back panel with the hooks

Note: A hammer is needed to tighten the hooks

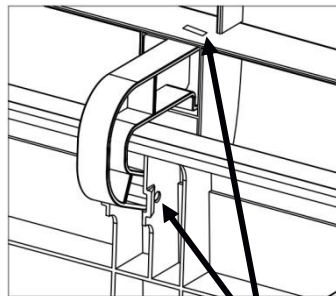
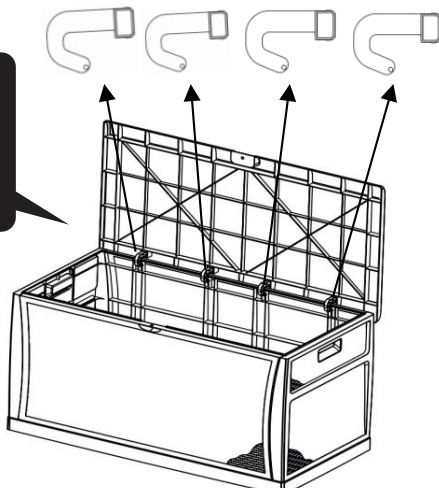

Fix the 4 hooks to the back panel first by click in the holes, then click the hooks with the lid holes

Return Policy

1. For any quality or non-quality problems, you can contact our customer service on Amazon first. We will provide timely reply and solutions for you.
2. For any quality problems, we can provide a free return for you.
3. For any non-quality reasons, such as "no longer needed, bought by mistake" and so on, we may charge you some shipping fee when receiving the returned items.