











ASSEMBLY INSTRUCTIONS







Thank you for purchasing this quality product . Be sure to check all packaging material carefully for small parts that may have come loose inside the carton during shipment .

"Hardware is attached underneath the seat bottom"

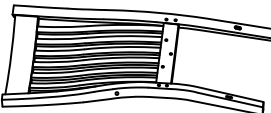
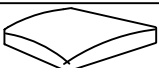
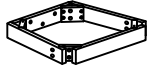
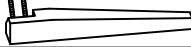
Hardware List :

| NO | DESCRIPTION | SIZE | SKETCH | QTY |
|----|---------------|-------------|---|-------|
| 1 | Wrench | 12x75 mm |  | 1pc |
| 2 | Allen Key | 58x23x4 mm |  | 1pc |
| 3 | Short Bolt | 1/4" x38 mm |  | 9pcs |
| 4 | Long Bolt | 1/4" x85 mm |  | 4pcs |
| 5 | Hex-Nut | 5/16" |  | 4pcs |
| 6 | Spring Washer | 5/16" x Ø12 |  | 17pcs |
| 7 | Flat Washer | 5/16" x Ø19 |  | 15pcs |
| 8 | Small Washer | 1/4" x Ø12 |  | 2pcs |
| 9 | Wood Screw | Ø8 x 50 mm |  | 4pcs |
| 10 | Wood Plug | Ø13 x 7 mm |  | 2pcs |

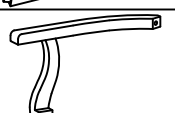
Components List :

| NO | DESCRIPTION | SKETCH | QTY |
|----|------------------------|---|-----|
| A | Back Frame |  | 1pc |
| B | Cushion Seat |  | 1pc |
| C | Seat Frame |  | 1pc |
| D | Front Leg (Left) |  | 1pc |
| E | Front Leg (Right) |  | 1pc |
| F | Side Stretcher (Left) |  | 1pc |
| G | Side Stretcher (Right) |  | 1pc |
| H | Arm Chair (Left) |  | 1pc |
| I | Arm Chair (Right) |  | 1pc |

Reminders

1. Use only the hardware supplied.
2. Once the chair is finished, level and tighten all the bolts.
3. Do not over-tighten bolts.
4. This item may require periodic tightening.

NOTE :

1. Hardware pack is located underneath the Cushion Seat (B)
2. Two or more people are needed for assembly. Please keep all hardware parts out of the reach of children.

Step1: Attach the Seat Frame (C) with Cushion Seat (B) to Back Frame (A) by using Flat Washer (7), Spring Washer (6) and Bolt (3&4). Secure with Allen Key (2)

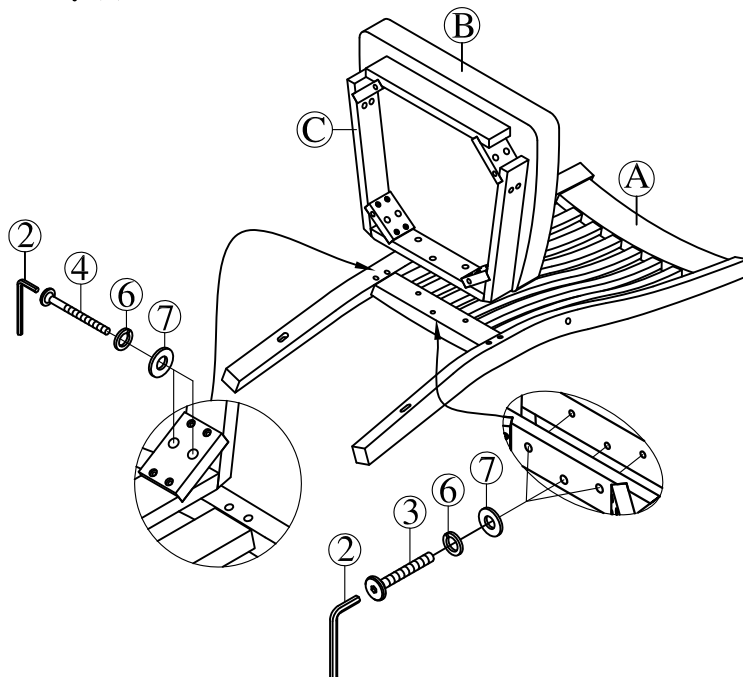

ASSEMBLY INSTRUCTIONS

Step 2: Attach Side Stretcher (F&G) to Back Frame (A) using Wood Screws (9) through pre-drilled holes of Side Stretcher (F&G) and Back Frame (A). Attach the assembled Front Leg (D&E) to Seat Frame (C) by using Flat Washers (7), Spring Washers (6) and Hex-Nut (5). Attach Front Legs (D&E) to the Side Stretcher (F&G) using Wood Screws (9) through pre-drilled holes on the Side Stretcher (F&G). Secure with Wrench (1)

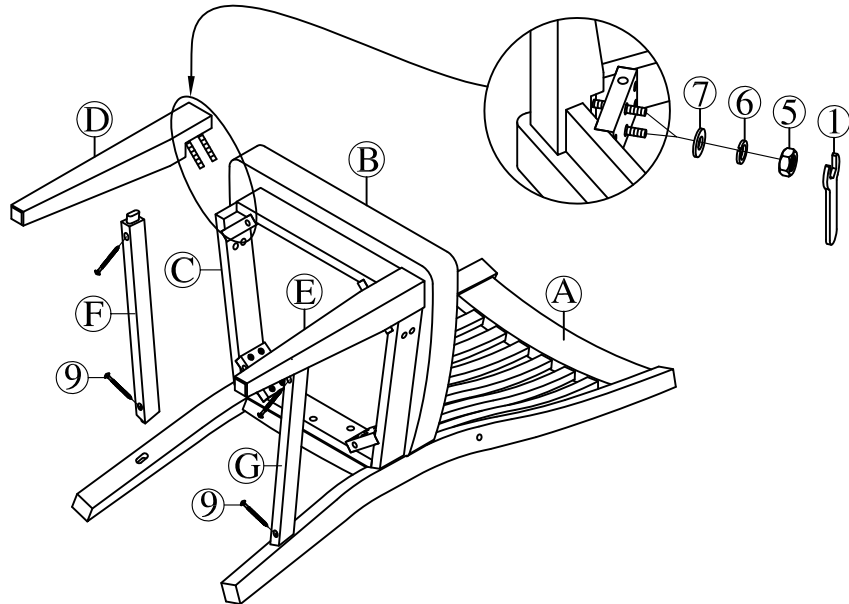

Step 3: Attach Arm Chair (H, I) to Chair Back (A) by inserting Small Washer (8), Spring Washer (6), Short Bolt (3) through bolts and secure with Allen Key (2). Insert Flat Washer (7), Spring Washer (6), Short Bolt (3) into the holes at the Seat Frame (C), secure with Allen Key (2). Then insert Wood Plug (10) into the hole as picture shown. Assembly is now complete. Thank you for choosing this product.

