

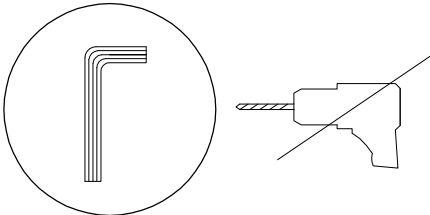

| | | |
|---|---|---|
|  |  |  |
|  |  |  |
| | | 10' |
| | | 1 |

| | | | | |
|---|---|--|---|---|
| <p style="text-align: center;">A</p>  <p style="text-align: center;">x 1</p> | <p style="text-align: center;">B</p>  <p style="text-align: center;">x 2</p> | <p style="text-align: center;">C</p>  <p style="text-align: center;">M6 x 30</p> <p style="text-align: center;">x 4</p> | <p style="text-align: center;">D</p>  <p style="text-align: center;">M6 x 20</p> <p style="text-align: center;">x 2</p> | <p style="text-align: center;">E</p>  <p style="text-align: center;">x 1</p> |
|---|---|--|---|---|

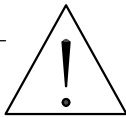
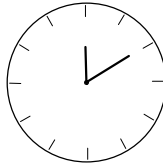
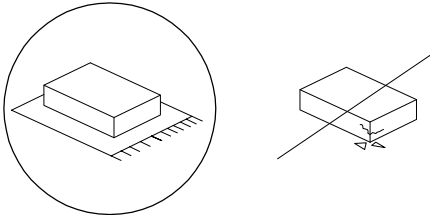
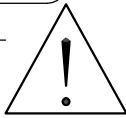

!

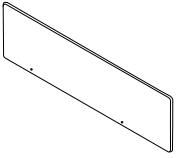
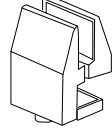
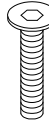
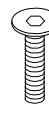
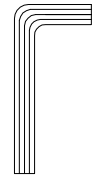
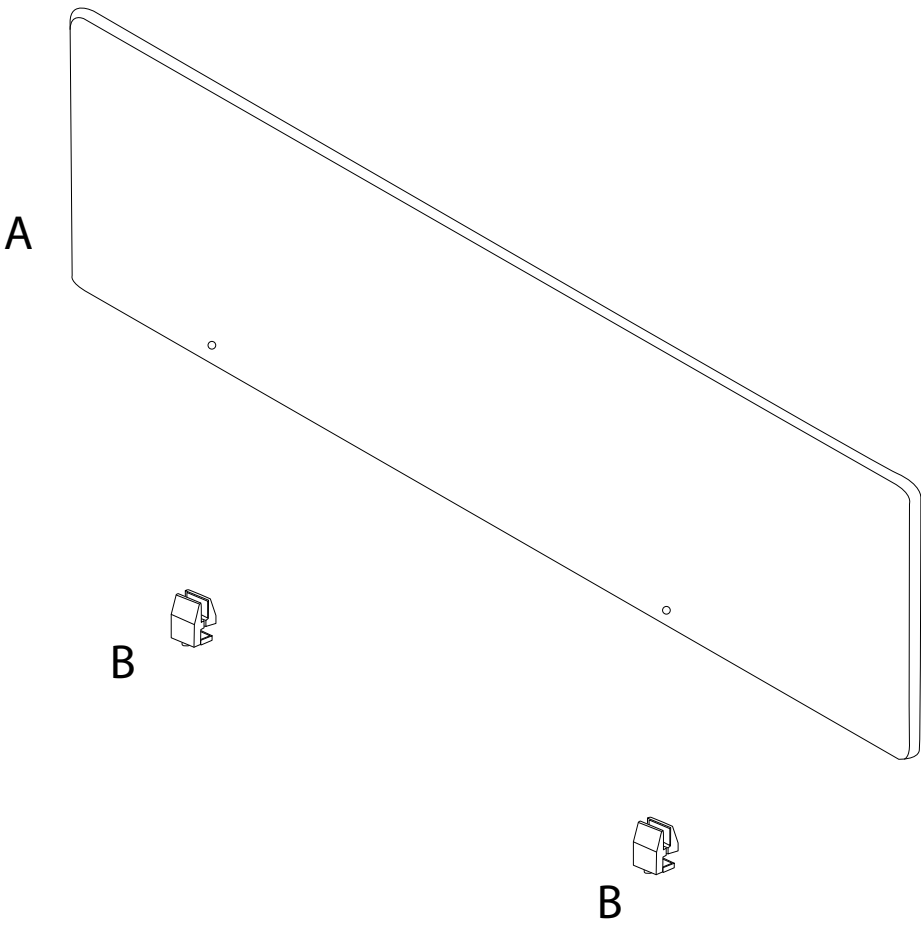
B

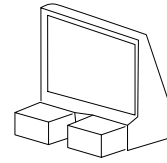
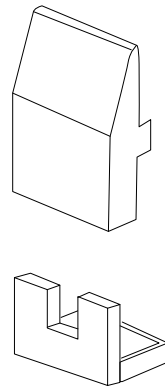
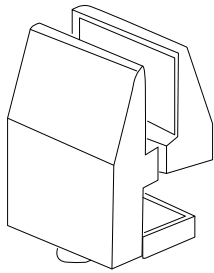

A

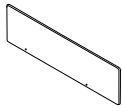

x 1

B

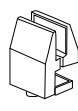

x 2

C

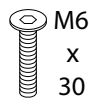

x 2

D

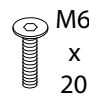

x 2

E

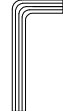

x 1

