



Portable Air Conditioner CF14

INSTRUCTION MANUAL



Thank you for purchasing Acekool Portable Air Conditioner. Before operating this unit, please read these instructions completely and keep the manual ready for further reference.

CONTENTS

■ INTRODUCTION	01
■ IDENTIFICATION OF PARTS	05
■ REMOTE CONTROLLER	09
■ PROTECTION	11
■ INSTALLATION	12
■ MAINTENANCE	14
■ TROUBLESHOOTING	16
■ USING INFORMATION	18

INTRODUCTION

Thank you for choosing this mobile air conditioner to provide you and your family with all of the “Home Comfort” requirements for your home, cottage or office. The appliance can be moved From room to room within your home and set-up in just minutes.

It is a multi-functional room air exchanging, air-processing appliance, designed to offer you the Functions of: Air Conditioning, Dehumidifying, Independent Fan and Heating. The external static.

Pressure at which the appliance was tested is 0 Mpa.

This manual will provide you with valuable information necessary for the proper care and maintenance. For your new appliance. Please take a few moments and read the instructions thoroughly. If properly. Maintained, your appliance will give you many years of trouble free operation.

ELECTRICAL SPECIFICATIONS

1. All wiring must comply with local and national electrical codes and be installed by a qualified electrician. If you have any questions regarding the following instructions, contact a qualified electrician.
2. Check available power supply and resolve any wiring problems before installation and operation of this unit.
3. For your safety and protection, this unit is grounded through the power cord plug when plugged into a matching wall outlet. If you are not sure whether the wall outlets in your home are properly grounded, please consult a electrician. If supply cord is damaged, it must be replaced by the manufacture, its service agent or similarly qualified persons in order to avoid a hazard.

IMPORTANT SAFETY INSTRUCTIONS

WARNING

To reduce the risk of fire, electrical shock or injury when using your air conditioner, follow these basic precautions:

1. Plug into a grounded 3 prong outlet.
2. Do not remove ground prong.
3. Do not use an adapter.
4. Do not use an extension cord.
5. Unplug air conditioner before servicing.
6. Use two or more people to move and install air conditioner.



Caution Risk of fire



A2L

7. This appliance can be used by children aged from 8 years and above and persons with reduced physical, sensory or mental capabilities or lack of experience and knowledge if they have been given supervision or instruction concerning use of the appliance in a safe way and understand the hazards involved.
8. Children shall not play with the appliance. Cleaning and user maintenance shall not be made by children without supervision.
9. If the supply cord is damaged, it must be replaced by the manufacturer, its service agent or similarly qualified persons in order to avoid a hazard.
10. The appliance shall be installed in accordance with national wiring regulations.
11. This appliance is not intended for use by persons (including children) with reduced physical, sensory or mental capabilities, or lack of experience and knowledge, unless they have been given supervision or instruction concerning use of the appliance by a person responsible for their safety. Young children should be supervised to ensure that they do not play with the appliance.
12. Do not use means to accelerate the defrosting process or to clean, other than those recommended by the manufacturer. Recommended by the manufacturer. The appliance shall be stored in a room without continuously operating ignition sources forexample: open flames, an operating.
Gas appliance or an operating electric heater.
Be aware that refrigerants.
May not contain an odour.
Do not pierce or burn.
13. When the machine malfunctions, do not repair it yourself. Please contact a professional organization or a professional trained maintenance personnel or a service organization recommended by the supplier for repair!
– the maximum refrigerant charge amount: R32/290g(10.23Oz)
14. Do not use means to accelerate the defrosting process or to clean, other than those recommended by the manufacturer.
15. The appliance shall be stored in a room without continuously operating ignition sources (for example: open flames, an operating gas appliance or an operating electric heater.)
16. Do not pierce or burn.
17. Be aware that refrigerants may not contain an odour.

SAFETY INSTRUCTIONS DURING SERVICING

1. The manual shall contain specific information about the required qualification of the working personnel for maintenance, service and repair operations. Every working procedure that affects safety means shall only be carried out by competent persons.
 2. Prior to beginning work on systems containing FLAMMABLE REFRIGERANTS, safety checks are necessary to ensure that the risk of ignition is minimised.
 3. Work shall be undertaken under a controlled procedure so as to minimise the risk of a flammable gas or vapour being present while the work is being performed.
 4. All maintenance staff and others working in the local area shall be instructed on the nature of work being carried out. Work in confined spaces shall be avoided.
 5. The area shall be checked with an appropriate refrigerant detector prior to and during work to ensure the technician is aware of potentially toxic or flammable atmospheres. Ensure that the leak detection equipment being used is suitable for use with all applicable refrigerants, i.e. non sparking, adequately sealed or intrinsically safe.
 6. If any hot work is to be conducted on the refrigerating equipment or any associated parts, appropriate fire extinguishing equipment shall be available to hand. Have a dry powder or CO₂ fire extinguisher adjacent to the charging area.
 7. No person carrying out work in relation to a REFRIGERATING SYSTEM which involves exposing any pipe work shall use any sources of ignition in such a manner that it may lead to the risk of fire or explosion. All possible ignition sources, including cigarette smoking, should be kept sufficiently far away from the site of installation, repairing, removing and disposal, during which refrigerant can possibly be released to the surrounding space. Prior to work taking place, the area around the equipment is to be surveyed to make sure that there are no flammable hazards or ignition risks. "No Smoking" signs shall be displayed.
 8. Ensure that the area is in the open or that it is adequately ventilated before breaking into the system or conducting any hot work. A degree of ventilation shall continue during the period that the work is carried out. The ventilation should safely disperse any released refrigerant and preferably expel it externally into the atmosphere.
 9. Repair and maintenance to electrical components shall include initial safety checks and component inspection procedures. If a fault exists that could compromise safety, then no electrical supply shall be connected to the circuit until it is satisfactorily dealt with. If the fault cannot be corrected immediately but it is necessary to continue operation, an adequate temporary solution shall be used. This shall be reported to the owner of the equipment so all parties are advised.
- Initial safety checks shall include:
- that capacitors are discharged: this shall be done in a safe manner to avoid possibility of sparking;
 - that no live electrical components and wiring are exposed while charging, recovering or purging the system;
 - that there is continuity of earth bonding.

10. During repairs to sealed components, all electrical supplies shall be disconnected from the equipment being worked upon prior to any removal of sealed covers, etc. If it is absolutely necessary to have an electrical supply to equipment during servicing, then a permanently operating form of leak detection shall be located at the most critical point to warn of a potentially hazardous situation

11. Particular attention shall be paid to the following to ensure that by working on electrical components the casing is not altered in such a way that the level of protection is affected. This shall include damage to cables, excessive number of connections, terminals not made to original specification, damage to seals, incorrect fitting of glands, etc. Ensure that the apparatus is mounted securely.

Ensure that seals or sealing materials have not degraded to the point that they no longer serve the purpose of preventing the ingress of flammable atmospheres. Replacement parts shall be in accordance with the manufacturer's specifications.

12. Do not apply any permanent inductive or capacitance loads to the circuit without ensuring that this will not exceed the permissible voltage and current permitted for the equipment in use.

13. Intrinsically safe components are the only types that can be worked on while live in the presence of a flammable atmosphere. The test apparatus shall be at the correct rating.

14. Replace components only with parts specified by the manufacturer. Other parts may result in the ignition of refrigerant in the atmosphere from a leak

15. Check that cabling will not be subject to wear, corrosion, excessive pressure, vibration, sharp edges or any other adverse environmental effects. The check shall also take into account the effects of aging or continual vibration from sources such as compressors or fans.

16. Under no circumstances shall potential sources of ignition be used in the searching for or detection of refrigerant leaks. A halide torch (or any other detector using a naked flame) shall not be used.

IDENTIFICATION OF PARTS

Control Panel

Cold Air Outlet

Signal Receptor

Transport Handle

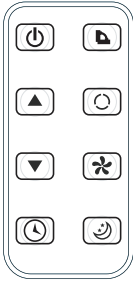

Remote Controller

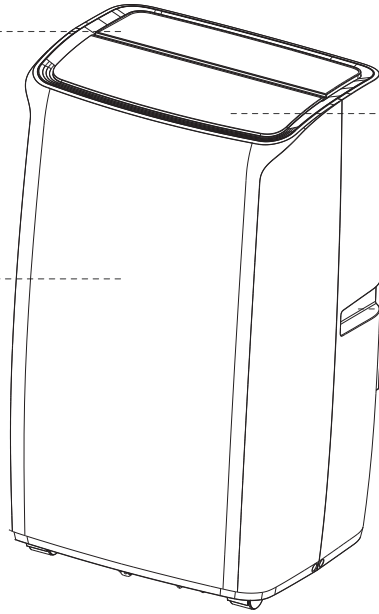

Air Outlet Hose



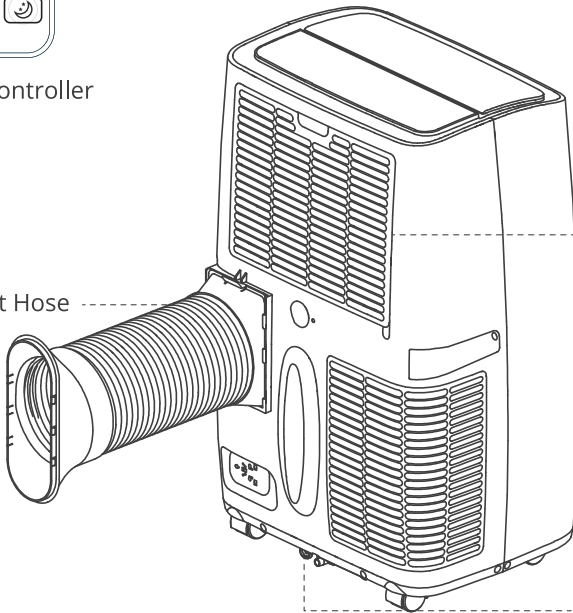





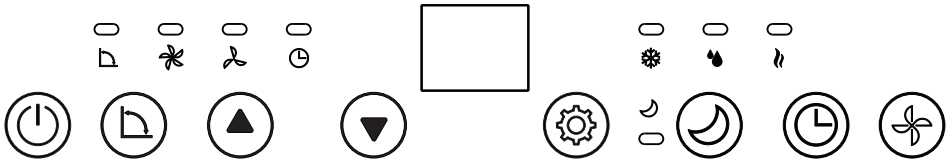



Evaporator
Air Intake



Primary Drain Port

CONTROL PANEL



- | | | |
|---|--|---|
|  On/Off button |  Speed button |  Timer/Temperature up button |
|  Timer button |  Mode button |  Timer/Temperature down button |
|  Swing button |  Sleep button |  Cool |
| | |  Dehumidify |
| | |  Fan |
| | |  low |
| | |  high Fan speed |

Control Panel Operation

• Cool, Dehumidify and Fan Mode Operation.

1. Turn on the unit

- Plug in then the unit beeps once.
- Press the “” button, then the unit is turned on. The LED displays the room temperature.



2. Select Operating Mode

Press the “” button to select a desired mode shown below:



3. Adjust Temperature

The temperature can be set within a range of 59-88°F.

Press “” or “” button to increase or decrease the temperature by pressing once.

The unit LED shows the target temperature for 5 seconds and then displays the room temperature.

4. Adjust Fan Speed

Press the "🌀" button to select a desired fan speed shown below:



5. Power

When you press "⏻" button again, the unit will emit "di" and stop working.

6. Swing

Press this "📏" button to set swing.

NOTICE:

Each mode working principle

* 💧 Mode

1. The up centrifugal fan will run at low speed, and the speed can't be adjusted.
2. The compressor and the down centrifugal fan will stop after running 8 mins, then run again after 6mins.
3. The unit adopts constant temperature dehumidifying mode, and the adjustment of temperature is no effective.

* ❄️ Mode

1. When the room temperature is higher than set temperature, the compressor starts to run.
2. When the room temperature is lower than set temperature, the compressor stop and operate at original set speed.





* 🌀 Mode

1. The up centrifugal fan runs at set speed, and the compressor does not run .
2. The adjustment of temperature is no effective.

-  **Operation**

1. Press "Timer" button to set Automatic Off time while the unit is running.
2. Press "Timer" button to set Automatic On time while the unit is ready.
3. The time can be adjusted within a range of 1 hour to 24 hour. Press the temp up (+) or temp down (-) button to increase or decrease the time 1 hour by pressing once.

-  **Operation**

1. The  operation is effective when the unit is under  mode.
2. Press the  button in  mode, then the unit will work under sleep mode and the up centrifugal fan will turn to low speed automatically. The set temperature will increase 1°C after one hour, and increase 2°C after two hours. After six hours, the unit will stop running.

-  **Operation**

1. When the swing button is activated, the swing blade swing up and down sutomatically. If you want to stop, press the button again.

Notice:

The main control board has memory function, when the unit is ready to run but in stop status, the main control board can memorize the initialization of working mode. When you tun on the unit, it will work as the same enactment of working-mode as last time, no need to reset the working mode again.

REMOTE CONTROLLER

The remote controller transmits signals to the system.

1. Button

The appliance will be started when it is energized or will be stopped when it is in operation, if you press this button.

2. Button

Press this button to select the operation mode.

3. Button

Used to select fan speed in sequence mode.

4, 5. and Setting Button

Used to adjust the room temperature and the timer.

6. Button

Used to set cancel  Mode operation.

7. Button

Used to set automatic of and automatic on time.

8. Button

Used for automatic Swing set.

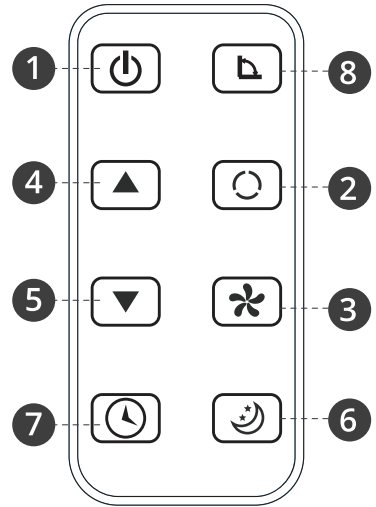

How To Install Batteries

• Inserting Batteries

1. Open the back cover, and take off the isolating film on the batteries
2. Put the batteries inside the slot, with anode and cathode in right directions;
3. Put on the back cover.

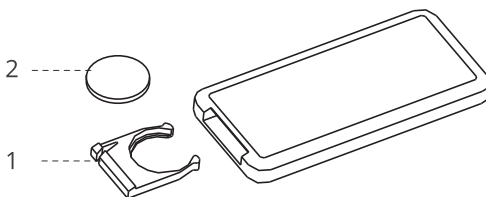

Slide the cover to open be sure the direction is correct

Notices:

- 1) The anode and cathode of the batteries must be corresponding to the signs of "+" and "-" on the remote control;
- 2) Do not use new battery cells together with run-down cells;
- 3) For long time no use, take out the batteries;
- 4) To prevent environmental pollution, take out the used batteries and dispose safely and appropriately.

• How to Use

To operate the air conditioner, aim the remote controller at the signal receptor. The remote controller will operate the air conditioner at distance of up to 5m (16.4 feet) when pointing at signal receptor of the air conditioner.

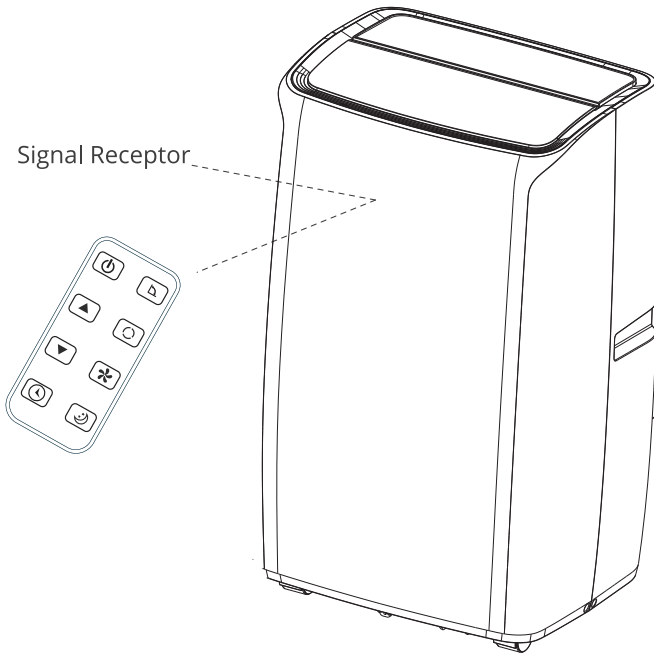

PROTECTION

Operating Condition

The protective device may trip and stop appliance in the cases listed below.

Cooling	Indoor air temperature is over 109.4°F
	Room temperature is below 59°F
Dehumidifying	Room temperature is below 59°F

If the air conditioner runs in COOLING or DRY mode with door or window opened for a long time when relative humidity is above 80%, dew may drip down from the outlet.

Features of protector

1. The protective device will work in the following cases.

Restarting the unit at once after operation stops or changing mode during operation, you need to wait 3 minutes.

2. If the plug is taken out, when you restart the appliance, it will return to the original mode, TIMER ON and TIMER OFF must be set again.

Drain Water

Special reminder: There is condensing water recycling hidden within this unit. The condensing water is partly kept recycling between the condenser and the water plate.

When the water level rises to the upper level, the float switch and water full indicator (E4) lights on to remind draining water. Please cut off the power supply, move the appliance to a suitable place, remove the drain plug, drain water completely. after the drain, re-install the plug, or the appliance may leak and make your room wet.

If the appliance is placed in a position admitting drain water, you also can connect the drain hose to the drain port drain water.

■ ■ ■ INSTALLATION

Installation Accessories

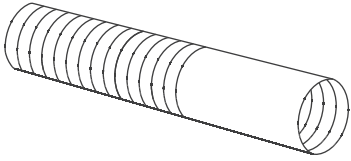

Air Exhaust Duct

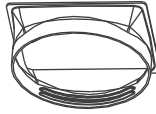

Connector Of Air Exhaust Duct

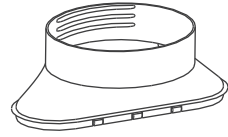

Window Exhaust Adapter

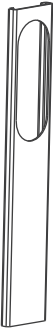

Baffle Plate



Remote Controller

Select the Best Location

- Beside a window, a door or a French window.
- Keep the required distance from the return air outlet to the wall or other obstacles at least 19 1/2" (60cm).
- Fix one end of the air hose on the air outlet underside the appliance.
- Extend the air hose to ensure that other end of the air hose has clearance between the window, door, or French window, or wall hole.
- Air outlet or intake cannot be blocked by protective grid or any obstacle.

Install Exhaust Hose and Adapter

How to connect the connectors to the Air exhaust duct

1. Extend the air exhaust duct by drawing out the two ends of the duct.

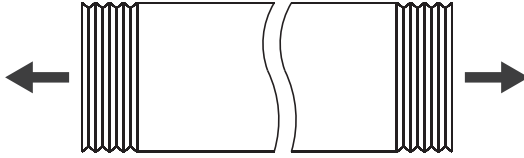

2. Screw the air exhaust duct into the connector of air exhaust duct.

3. Screw the connector of window into the plastic connector.

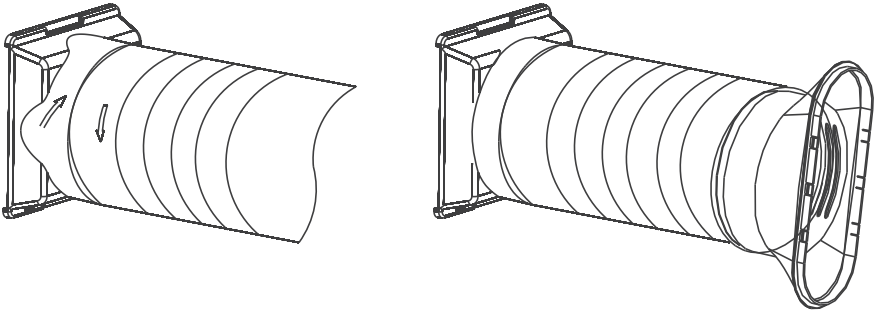

4. Connect the connector of air exhaust duct to the unit.

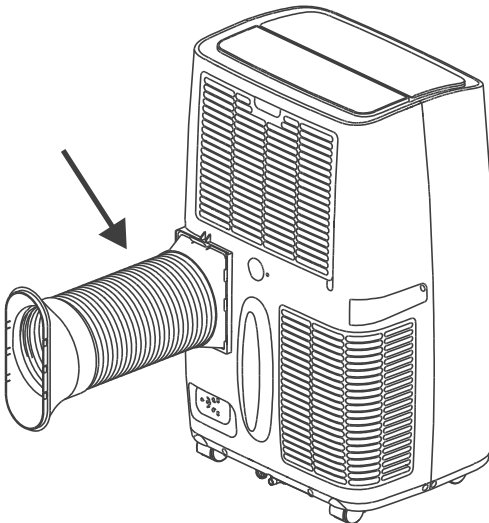

MAINTENANCE

Appliance Maintenance

1. Cut off the power supply

Turn off the appliance first before disconnecting from power supply.

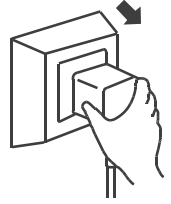

2. Wipe with a soft and dry cloth.

Use lukewarm water (below 40°C (104°F) to clean if the appliance is very dirty.



Use a dry and soft cloth to clean it.

3. Never use volatile substance such as gasoline or polishing powder to clean the appliance.



4. Never sprinkle water onto the main unit.

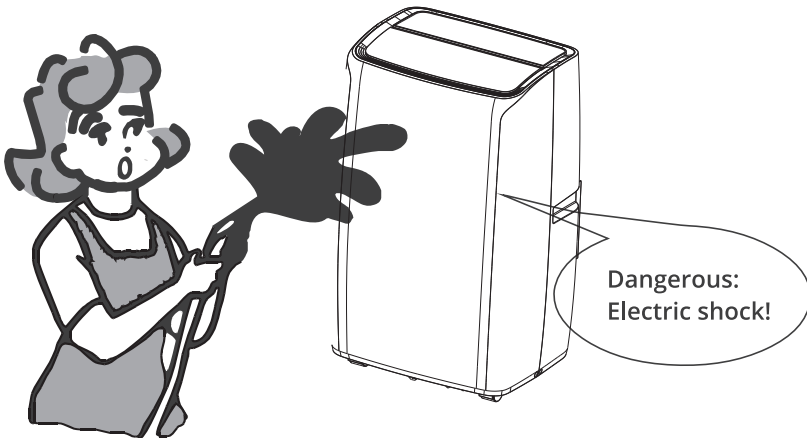

Air Filter Maintenance

It is necessary to clean the air filter after using it for about 100 hours. Clean it as follows:

1. Stop the appliance and remove the air filter.

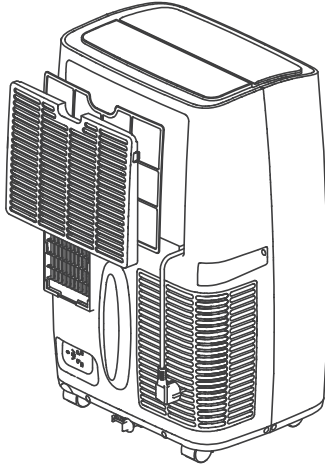

2. Clean and reinstall the air filter.

If the dirt is conspicuous, wash it with a solution of detergent in lukewarm water. After cleaning, dry it in a shaded and cool place, then reinstall it.

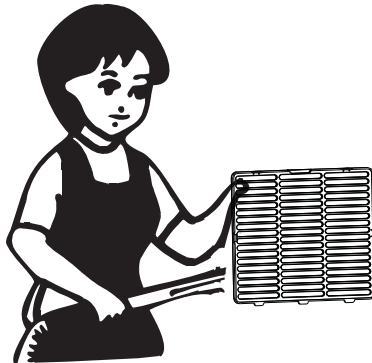



3. Clean the air filter every two weeks if the air conditioner operates in an extremely dusty environment.

Maintenznce After Using

1. If the appliance will not be used for a long time, be sure to Pull out the primary and the secondary rubber plug of the drain port, in order to drain the water.
2. Keep the appliance running with fan only for a half day during a sunnyday to dry the appliance inside and prevent from going moldy.
3. Stop the appliance and pull out the power supply plug, then take out the batteries of remote controller and store appliance properly.
4. Clean the air filter and reinstall it.
5. Remove the air hoses and store them properly, and cover the hole tightly.

TROUBLESHOOTING

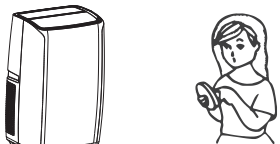
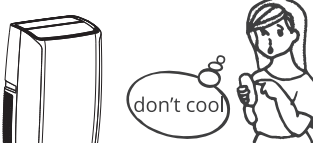
The following cases may not always be a malfunction, please check suggestions below before asking for service.

Trouble	Analysis
<p>Does not run</p> 	<ul style="list-style-type: none"> • If the protector trip or fuse is blown. • Please wait for 3 minutes and start again, protector device may be preventing unit from working. • If batteries in the remote controller are exhausted. • If the plug is not properly plugged in.
<p>Runs for a short while only</p> 	<ul style="list-style-type: none"> • If the set temperature is close to room temperature, you can lower the set temperature. • Air outlet is blocked by obstacle. Take the obatacle away.
<p>Runs but not cooling</p> 	<ul style="list-style-type: none"> • If the door or winow is open. • If there is another appliance heat-working. Like heater or lamp, etc. • The air filter is dirty, please clean it. • Air outlet or intake is blocked. • Set temperature is too high.
<p>Water leak during moving</p> 	<ul style="list-style-type: none"> • Drain the condensate before moving. • To avoid water leakage, please locate the unit on flat ground.

Trouble	Analysis
<p>Does not run and water full indicator "E4"</p> 	<ul style="list-style-type: none"> • Pull out the rubber plug to drain water. • If it is often in this state, please contact qualified service technical.

Before claiming repair, check the machine as follows:

Failures	Causes	Solutions
Machine fails to start up.	Power supply failure: 1. Not plugged; 2. Plug or socket damaged; 3. Fuse broken.	1. Plug in; 2. Replace the power cord or socket; 3. Replace the fuse by service provider (Specification: 6.3A/250VAC).
Machine automatically stops.	TIMING shut down or set temperature reached.	Restart or wait for auto-switch.
No cold air under COOLING mode.	1. Room temperature lower than set temperature; 2. Machine enters into anti-frost protection.	1. This is a normal phenomenon, the machine will auto-switch while the room temperature is higher than the set temperature; 2. The machine will auto switch after anti-frost protection is over.
LED displays failure code "E2"	Room temperature sensor fails or damaged.	Replace the room temperature sensor.
LED displays failure code "E3"	The evaporator oil pipe sensor fails or damaged.	Replace the evaporator coil pipe sensor.
LED displays failure code "E4"	Water-full warning.	Drain out the water.

■ ■ ■ USING INFORMATION

Cautions

- Keep the unit at least 1 meter away from TV or radios to avoid electromagnetic interference.
- Do not expose the unit under direct sun light to avoid surface color fading.
- Do not tilt the unit for more than 35° or upside-down while transporting.
- Place the unit on a flat surface with less than 5° inclination.
- The unit operates more efficiently in certain room locations (see Technical Specifications).
- Empty the condensed drainage pan before putting the unit in storage to prolong the unit lifetime at the end of the season.
- Do not use chemical solvents (e.g. Benzene, alcohol-glazer) to clean the unit surface to avoid scratching, damaging the surface.
- Make sure to cut off the power before disassembling or installing the air-inlet fence.
- Please empty the water from the water tank, if you want to move the machine.
- The battery must be removed from the appliance before it is scrapped.
- The battery is to be disposed of safely.
- The plug must be removed before cleaning, maintaining or filling the appliance.



Model:FDP41-3034ZR3

Company: Creative Innovation INC

Address: 13001 WOODRIDGE AVE EDISON NJ 08837-3461 992

CuStomer Service Email: support@acekool.vip

Website: <https://www.acekool.vip>

Made in China



Intertek
4009294

此页删除

材质：105g铜版纸

印刷：单黑

印刷尺寸：148X210 mm

装订：骑马钉

注：封面/封底/目录背面不印