

# Assembly Instructions





**Caution: You must read this before you proceed**

**Please look in Gaslift pack for hardware packs**

## Office Chair

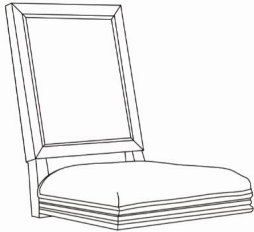
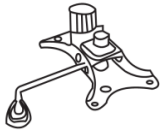

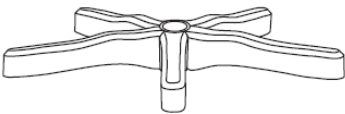
## Parts List

Label	Picture	Description	QTY
A		Chair Seat	1
B		Mechanism	1
C		Gaslift	1
D		Chair Base	1
E		Caster	5

# Hardware

①		Bolts (M8*30 mm)	5
②		Spring Washer	5
③		Washer	5
④		Allen Wrench	1

# Assembly Preparation

Before Beginning Assembly:

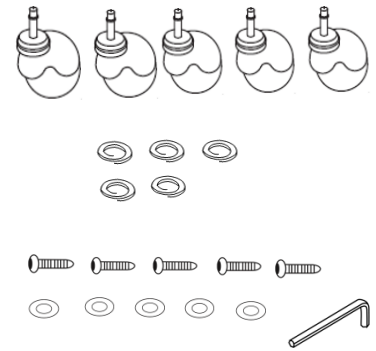
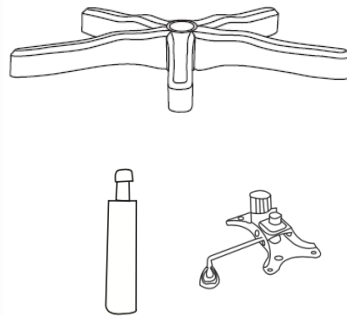
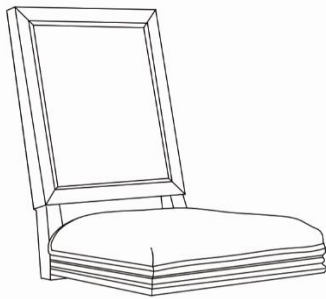

- Read instructions, cover to cover-



- Have 2 adults on hand for assembly-



- Do not assemble on flooring or carpet-



- Assemble on a clean non-marring surface (packing foam)-



- Save all packaging until finished-

# Assembly Steps

## Overview

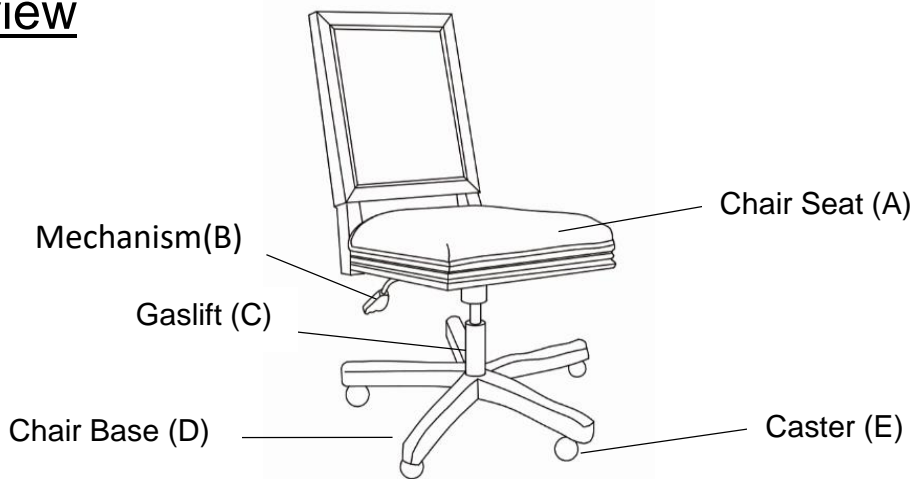

This Office Chair has multiple parts and may require up to 30 minutes to assemble. To give you an overview of the Office Chair parts, the above picture is to help you put the various parts into perspective. Please read through the instructions below to familiarise yourself with the parts and steps before assembly.

## Step 1

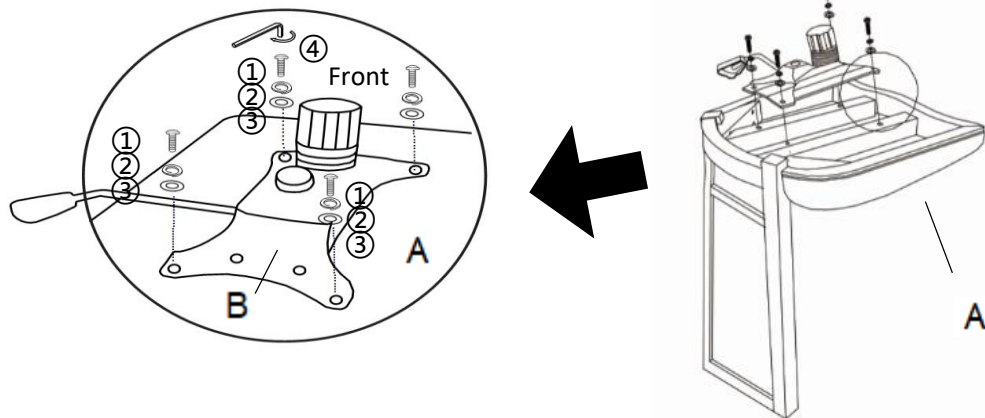

Unpack and place all parts on a clean, non-marring surface.

Place the bottom of the Chair Seat(A) on a clean, non-marring table.

Attach the Mechanism (B) to the Chair Seat(A) using the Bolts(①), Spring Washers(②) and Washers (③), with the Allen Wrench (④).

**Fully tighten the Bolts in a sequential manner. Make sure to use the right front end of the Mechanism (B)when attaching it to the Chair Seat(A).**

## Step 2

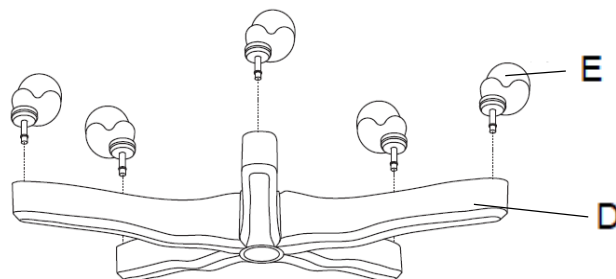

Insert the Casters (E) into the mounting positions of the Chair Base (D) as shown above.

### Step 3

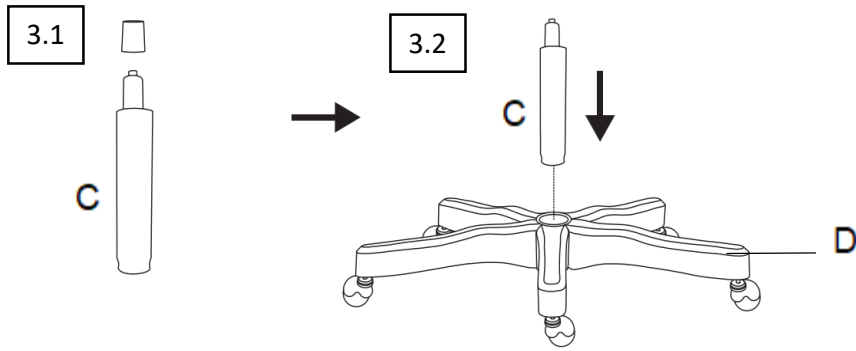

3.1: Remove the black cap on the Gaslift ©.

3.2: Insert the Gaslift (C) into the mounting position on the Chair Base (D) as pictured.

**Note: The Gaslift (C) will self-lock into place.**

### Step 4

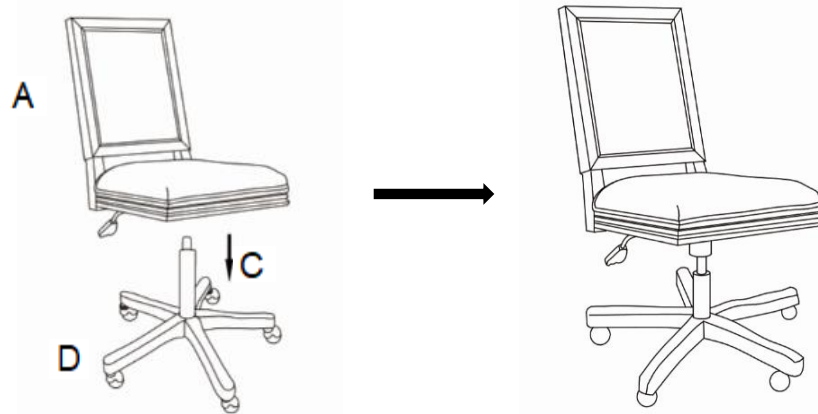

Turn the Chair Seat (A) right side up.

Attach the Seat (A) to the Chair Base (D) as pictured.

Make sure all parts are connected and securely locked into position.

### Step 5

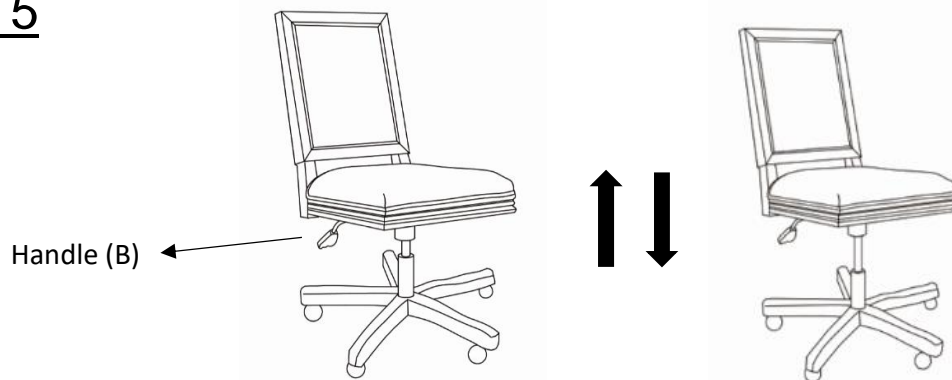

Your Office Chair is ready for use.

You can use the Mechanism's (B) handle to raise or lower the Chair.

Note: You can also use the Mechanism's handle (B) to control the office chair's wobble function.

This Office Chair can only be used on a flat, level surface.

## Care & Maintenance



- Furniture may scratch floors. We recommend using furniture pads to protect your floors.



- Do not put hot items directly on furniture surface.



- Do not clean furniture with harsh cleansers or polish.



- Do not place furniture under direct sunlight.



- Do not place furniture near heating or cooling vents.



- Do not write on furniture without a padded barrier to protect the surface.



- Do not place furniture outside . For indoor use only.



- Not for commercial use. For residential use only.



- Stains may be removed with mild soap solution and damp cloth.



- Children should not climb or jump on the furniture.



- Dust and pick-up spills using a clean, non-colored, lint-free cloth.