

Top View

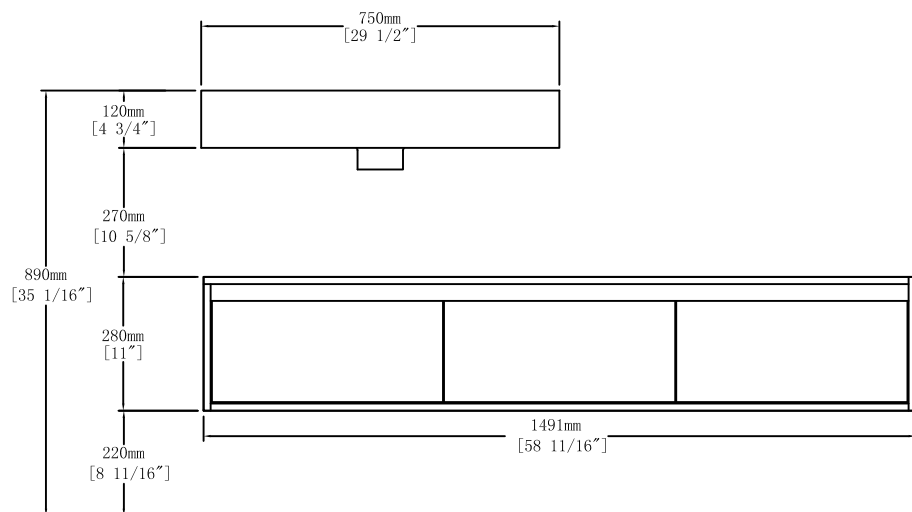

Front View

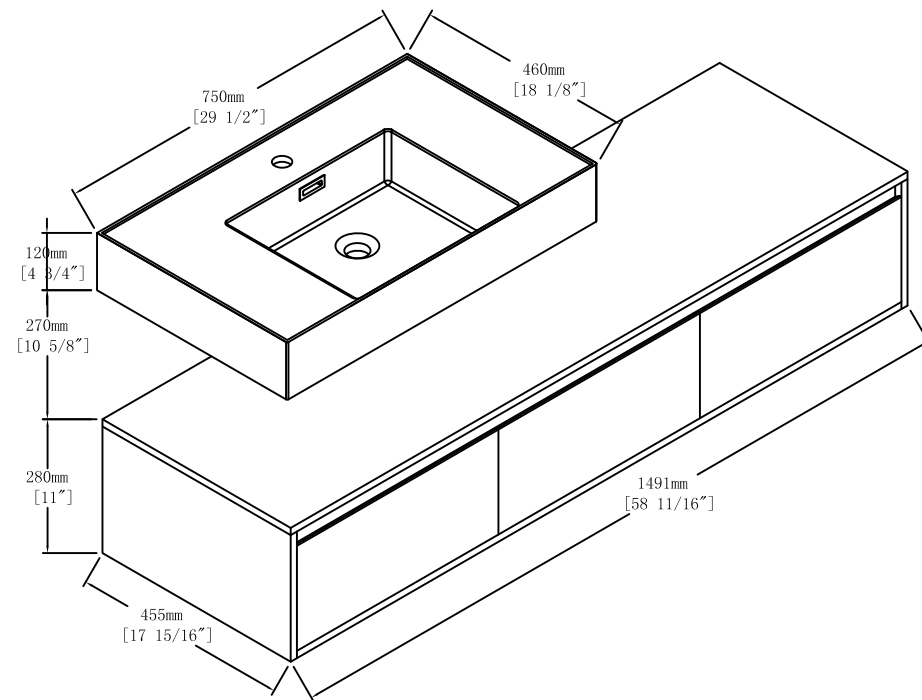
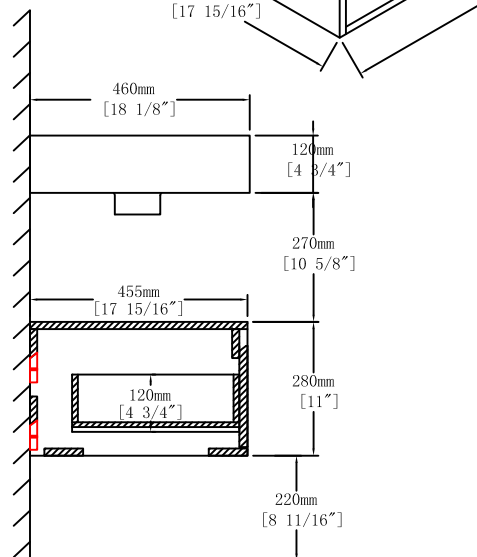

Side View

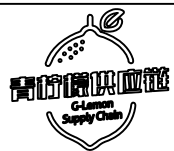

Item NO.

BV B09460-30"

Version

V1

Project

Date

2024-7-15