

Storage Cabinet

## EN

Thank you for purchase our products, please contact us if you have difficulty with assembly or need replacement parts. Our customer service is here to assist you.

Please attach your User Name or Order ID so that we can assist you better.

### WARNING

Serious or fatal injury may occur from unexpected assembly or use.

1. During the assembly process, keep all parts away from babies or children.
2. Always securely fix this product to the wall. Make sure the wall area to be drilled is free from hidden electrical wires, water and gas pipes.
3. Use of tip-over restraints may only reduce, but not eliminate the risk of tip-over.
4. Unless specially designed to accommodate, do not set heavy objects on top of this product.
5. Place the heaviest items on the lowest shelf.
6. Never allow children to climb or bang on drawers, doors or shelves.

## DE

Vielen Dank für Ihren Kauf von unseren Produkten. Bitte kontaktieren Sie uns, wenn sie probleme mit Montage haben oder Ersatzteile benötigen. Unser Kundenservice ist für Sie da. Bitte geben Sie Ihren Benutzernamen oder Ihre Bestellnummer an, damit wir Sie besser unterstützen können.

### WARNUNG

Bei unerwarteter Montage oder Verwendung können schwere oder tödliche Verletzung auftreten.

1. Legen Sie in den Montageprozess alle Teile weg von Babys oder Kindern.
2. Stellen Sie sicher, dass der gebohrte Wandbereich frei von verborgenen Stromkabeln, Wasser- und Gasleitungen ist, wenn Sie dieses Produkt an der Wand befestigen.
3. Die Verwendung von Kippsicherungen kann die Gefahr eines Kippens nur verringern, jedoch nicht beseitigen.
4. Setzen Sie bitte keine schweren Gegenstände auf dieses Produkt, es sei denn, dass das Produkt speziell für die Unterbringung konzipiert wird.
5. Legen Sie bitte die schwersten Gegenstände auf das unterste Regal.
6. Erlauben Sie nie Kindern, auf Schubladen, Türen oder Regale zu klettern oder zu knallen.

# Assembly Steps



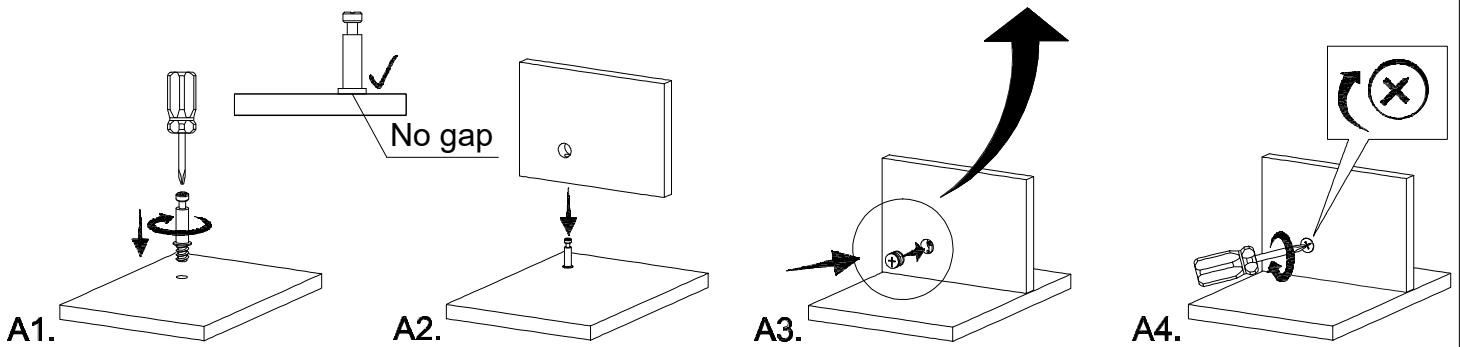
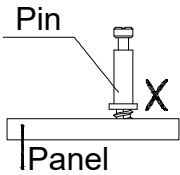
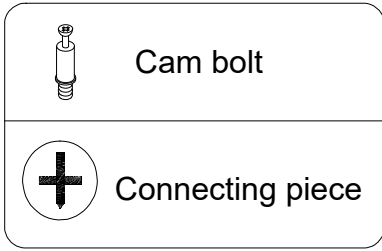

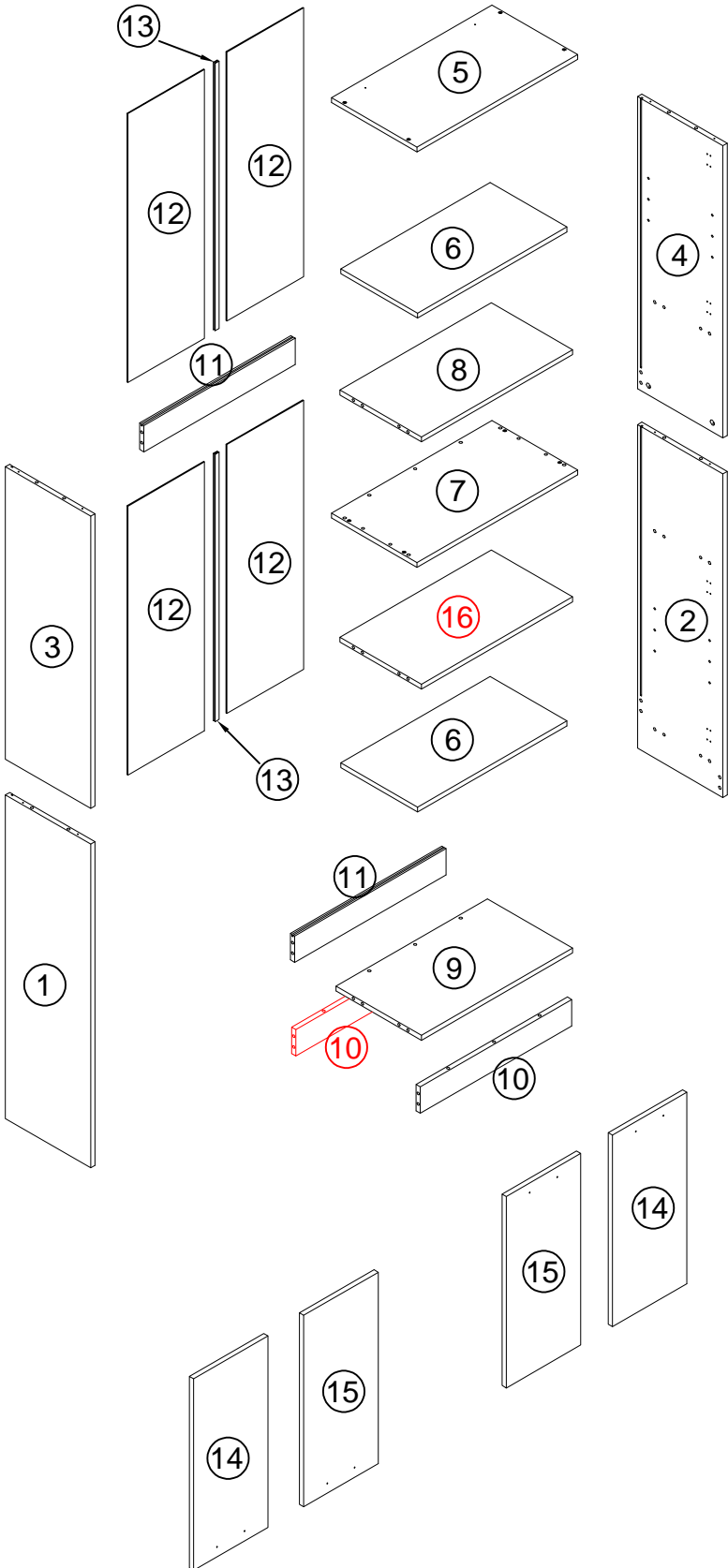

## CAM BOLT INSTALLATION AS BELOW:

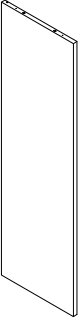

Parts List(EN)/Teile Liste(DE)



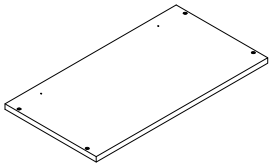
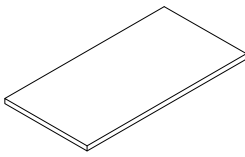
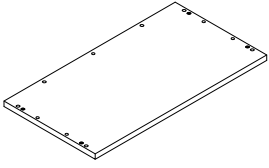
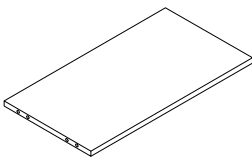
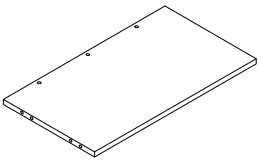
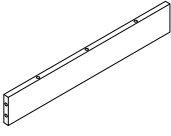
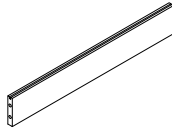

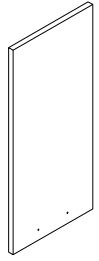
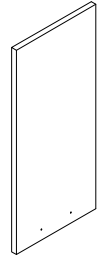
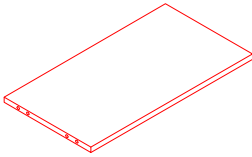



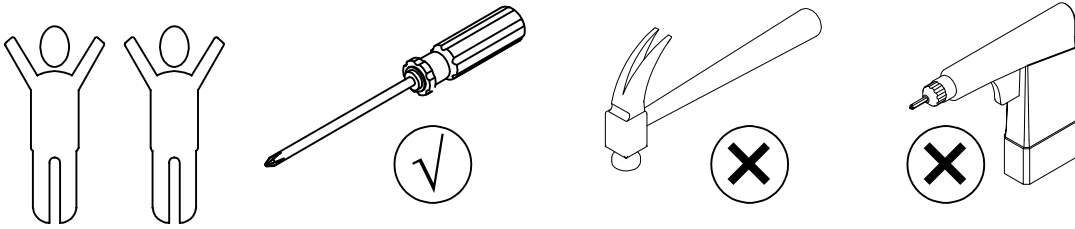

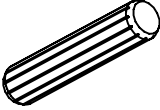
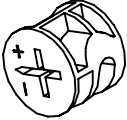

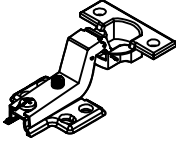
# Parts List(EN)/Teile Liste(DE)

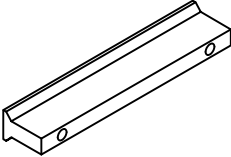
 <p>① 1PCS</p>	 <p>② 1PCS</p>	 <p>③ 1PCS</p>	 <p>④ 1PCS</p>
 <p>⑤ 1PCS</p>	 <p>⑥ 2PCS</p>	 <p>⑦ 1PCS</p>	 <p>⑧ 1PCS</p>
 <p>⑨ 1PCS</p>	 <p>⑩ 2PCS</p>	 <p>⑪ 2PCS</p>	 <p>⑫ 4PCS</p>
 <p>⑬ 2PCS</p>	 <p>⑭ 2PCS</p>	 <p>⑮ 2PCS</p>	 <p>⑯ 1PCS</p>

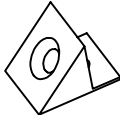
# Hardware List(EN)/Hardware Liste(DE)

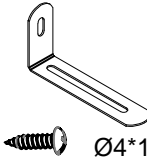
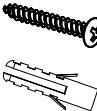

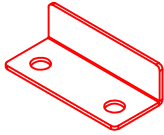

<p><b>A</b></p>  <p>M6*32mm <b>40+2PCS</b></p>	<p><b>B</b></p>  <p>Ø8*30mm <b>28+2PCS</b></p>	<p><b>C</b></p>  <p>Ø15*9.5mm <b>40+2PCS</b></p>	<p><b>D</b></p>  <p>Ø3.5*14mm <b>52+2PCS</b></p>
<p><b>E</b></p>  <p>8PCS</p>	<p><b>F</b></p>  <p>M4*18mm <b>8+1PCS</b></p>	<p><b>G</b></p>  <p>4PCS</p>	<p><b>H</b></p>  <p>8PCS</p>
<p><b>I</b></p>  <p>20+2PCS</p>	<p><b>J</b></p>  <p>Ø3*16mm <b>20+2PCS</b></p>	<p><b>K</b></p>  <p>Ø4*12mm 2SETS</p>	<p><b>L</b></p>  <p>Ø4*35mm 2SETS</p>
<p><b>M</b></p>  <p>Ø21mm <b>4PCS</b></p>	<p><b>N</b></p>  <p>Ø4*45mm <b>8+1PCS</b></p>	<p><b>O</b></p>  <p><b>2PCS</b></p>	

# Assembly Steps(EN) / Montageschritte(DE)

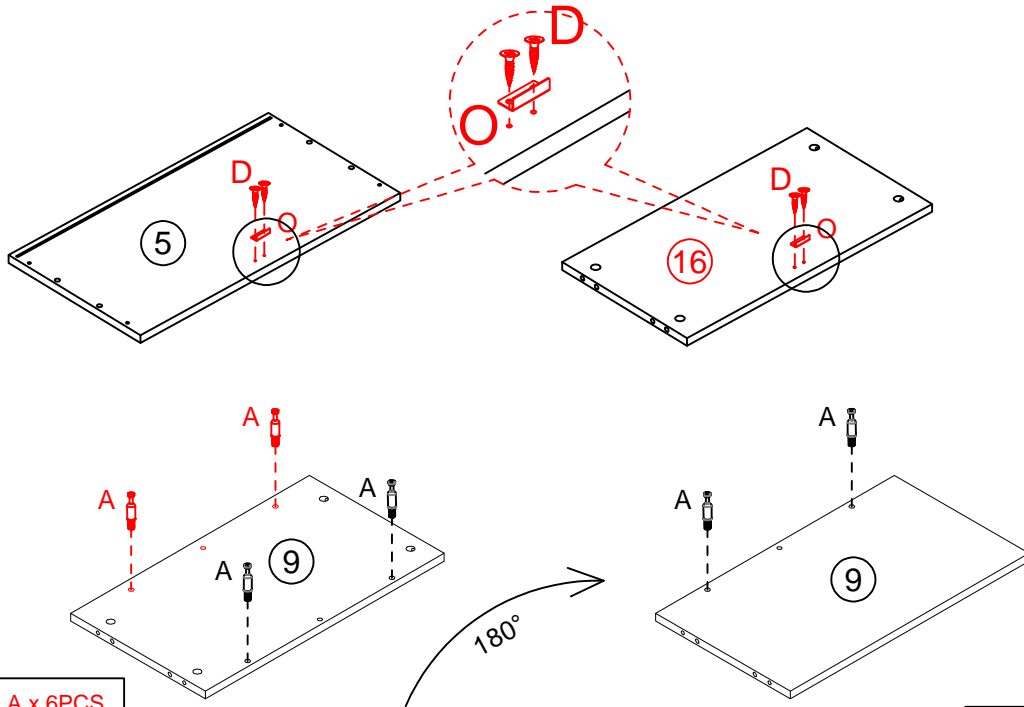
Step:1



	A x 6PCS
	D x 4PCS
	O x 2PCS

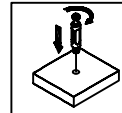

Step:2

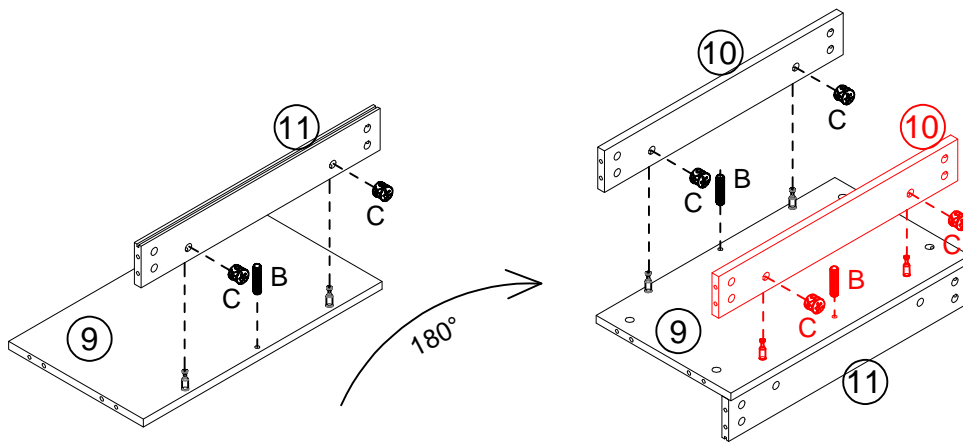

	B x 3PCS
	C x 6PCS

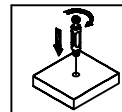

# Assembly Steps(EN) / Montageschritte(DE)

Step:3

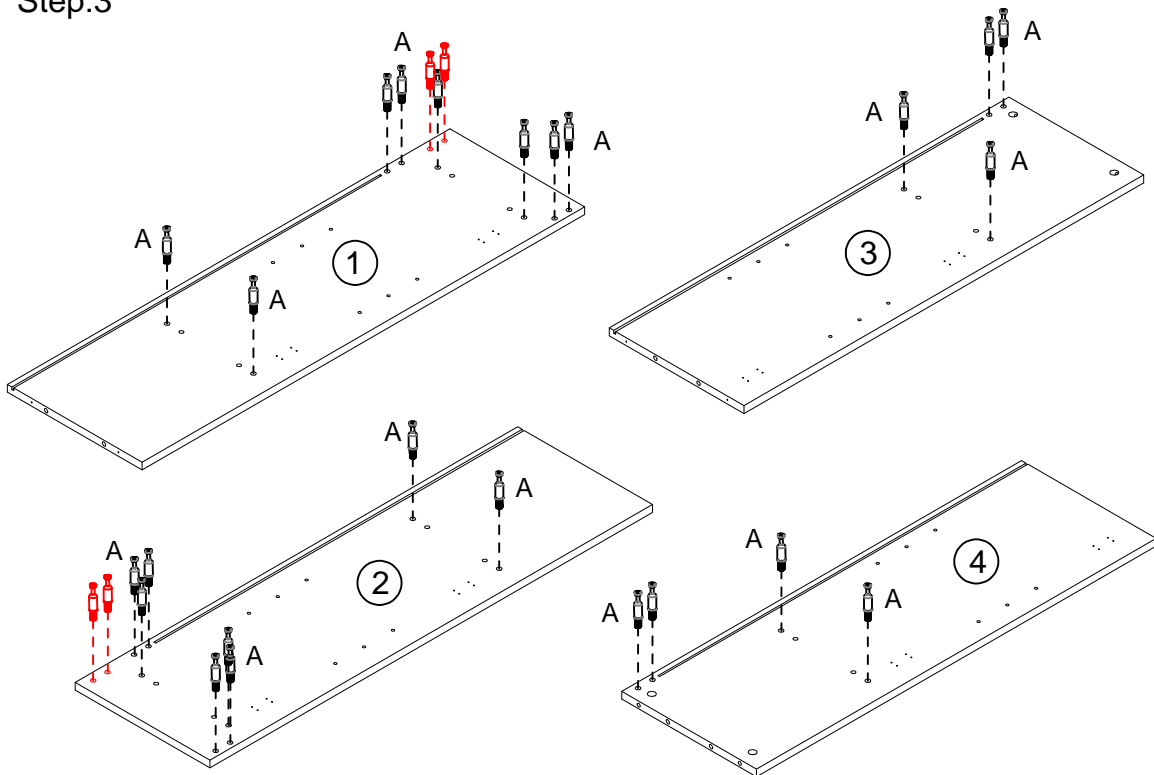

A x 28PCS

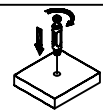

Step:4

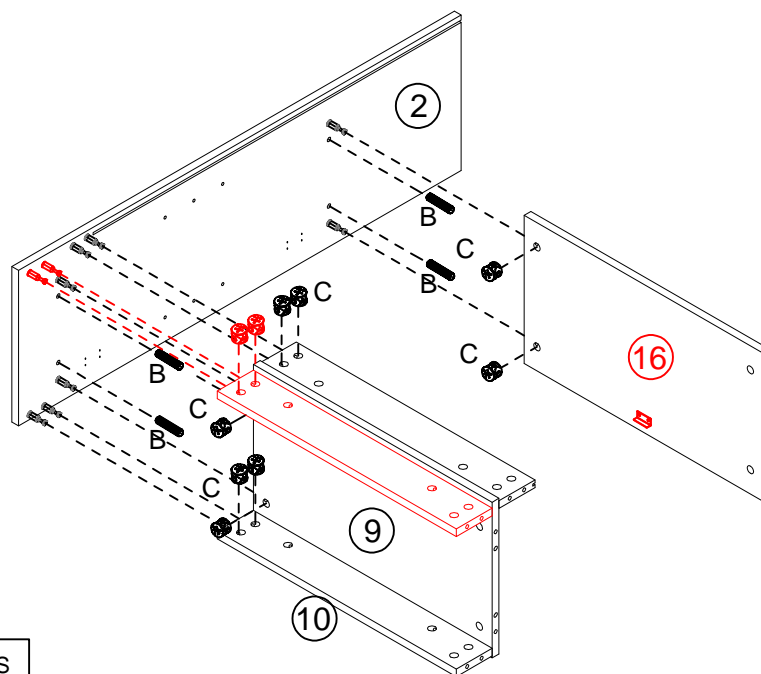

B x 4PCS



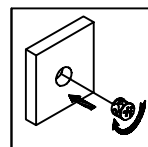

C x 10PCS

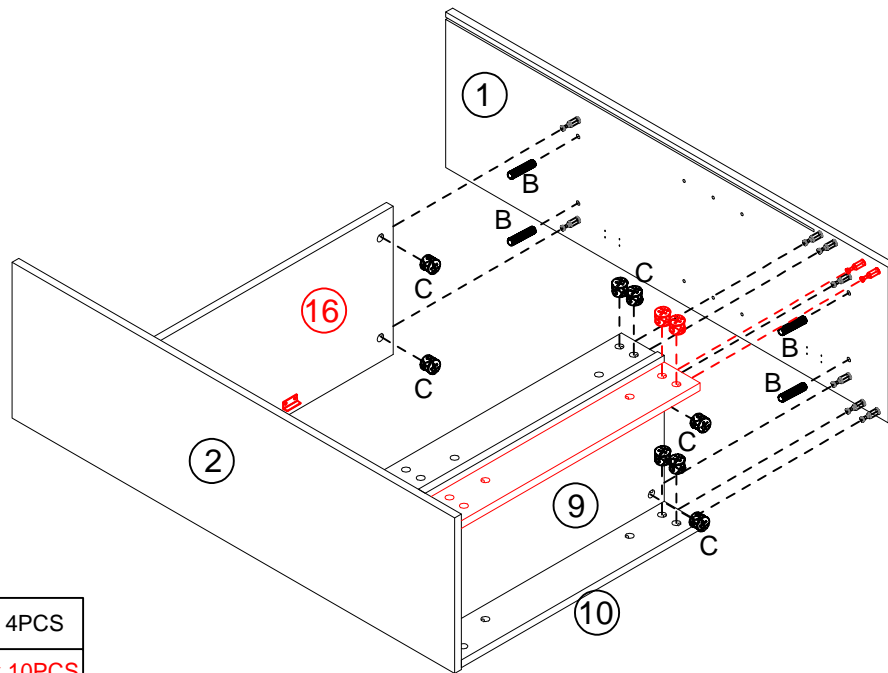

# Assembly Steps(EN) / Montageschritte(DE)

Step:5



	B x 4PCS
	C x 10PCS

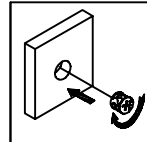

Step:6

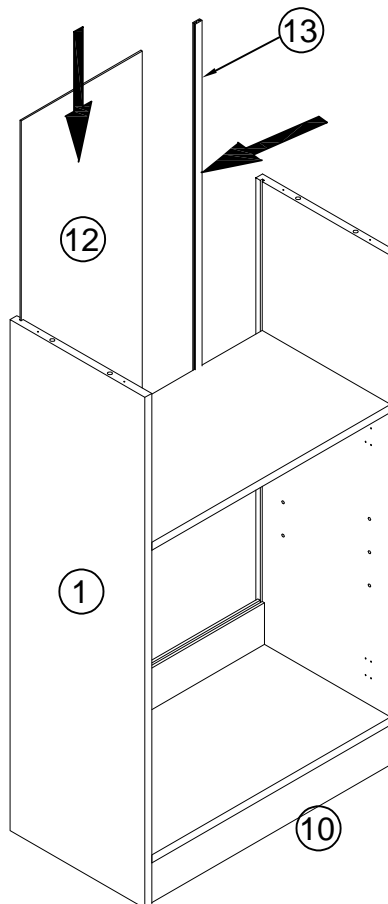



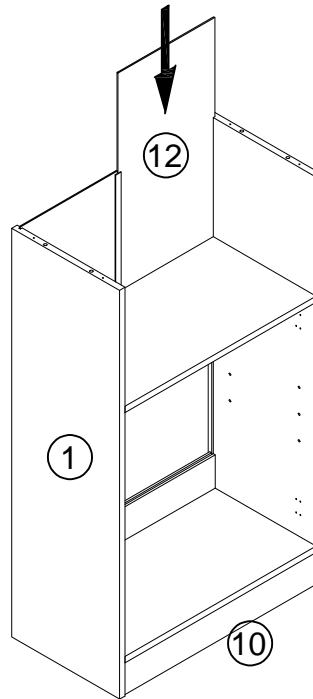

# Assembly Steps(EN) / Montageschritte(DE)

Step:7

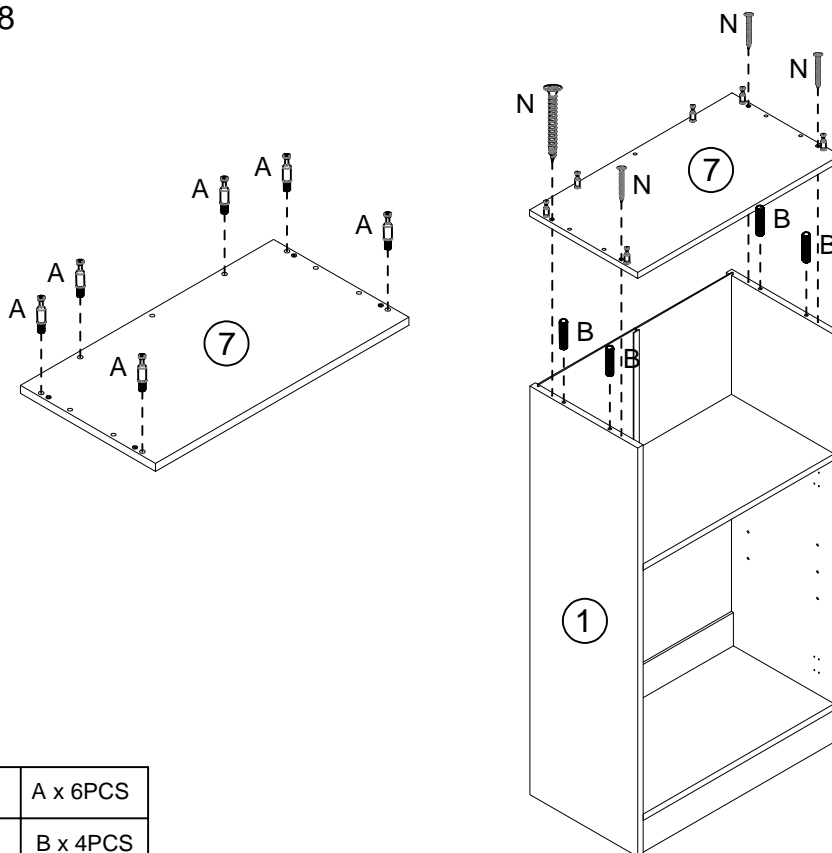

Step:8





	A x 6PCS
	B x 4PCS
	N x 4PCS

# Assembly Steps(EN) / Montageschritte(DE)

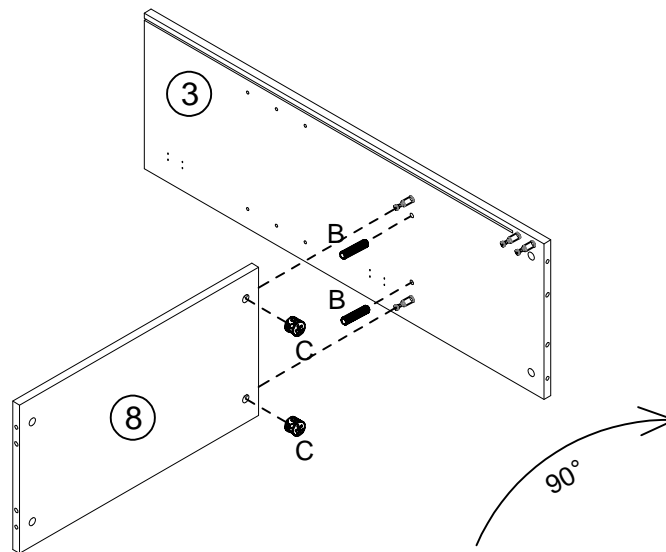
Step:9



	B x 2PCS
	C x 2PCS

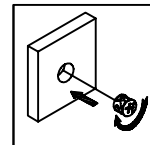

Step:10

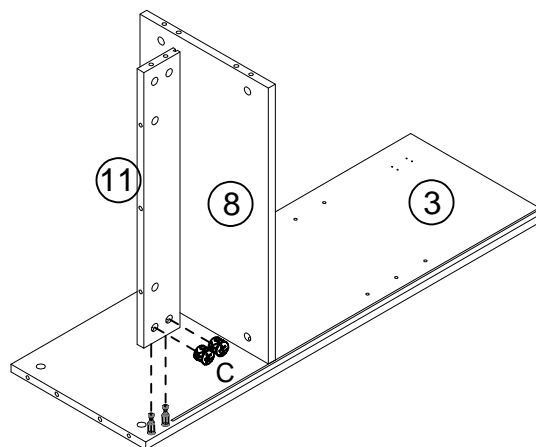

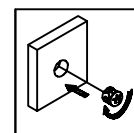

	C x 2PCS
---	----------

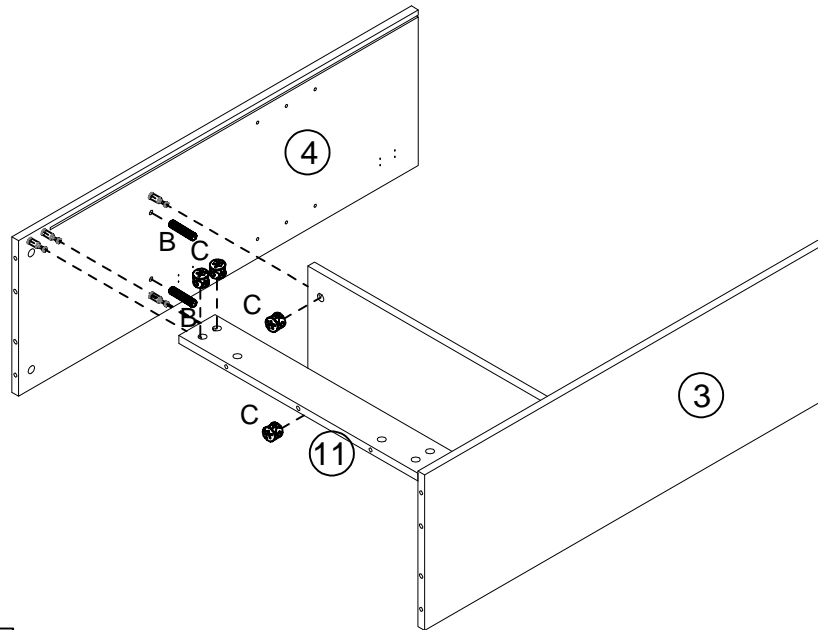

# Assembly Steps(EN) / Montageschritte(DE)

Step:11



	B x 2PCS
	C x 4PCS

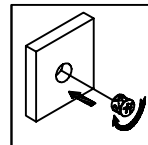

Step:12

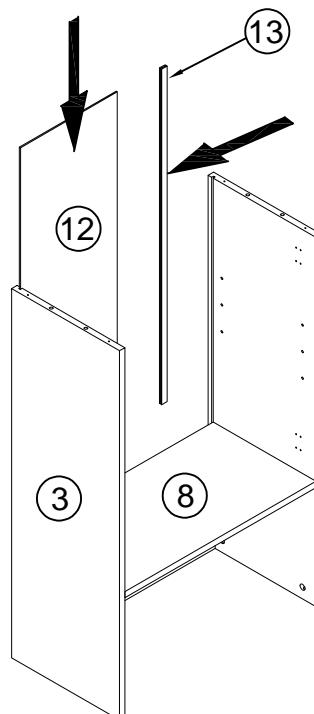

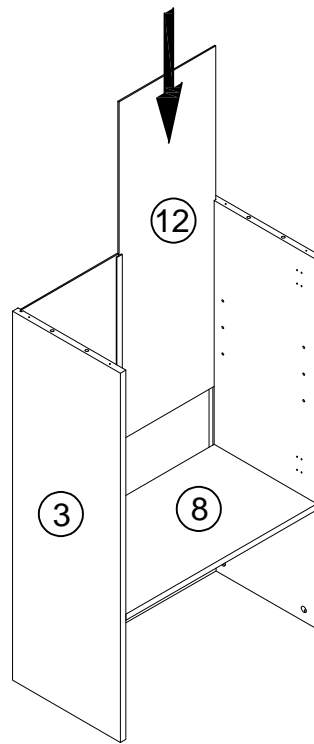

# Assembly Steps(EN) / Montageschritte(DE)

Step:13

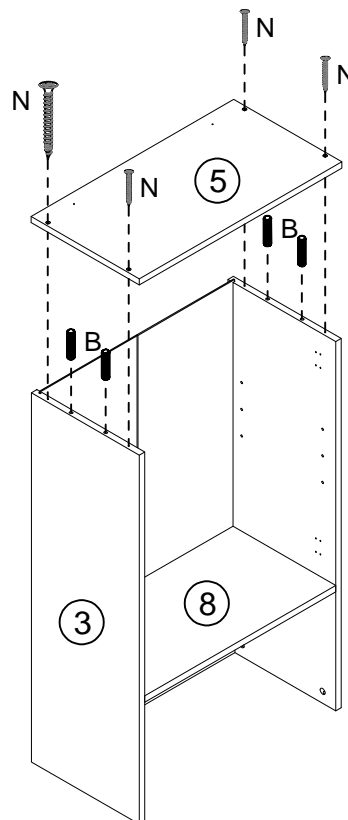

Step:14





	B x 4PCS
	N x 4PCS

# Assembly Steps(EN) / Montageschritte(DE)

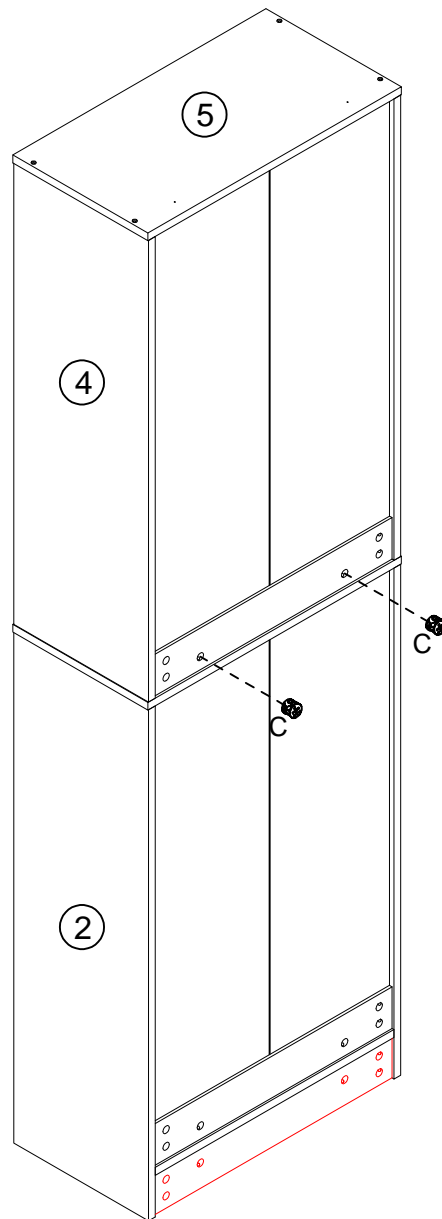
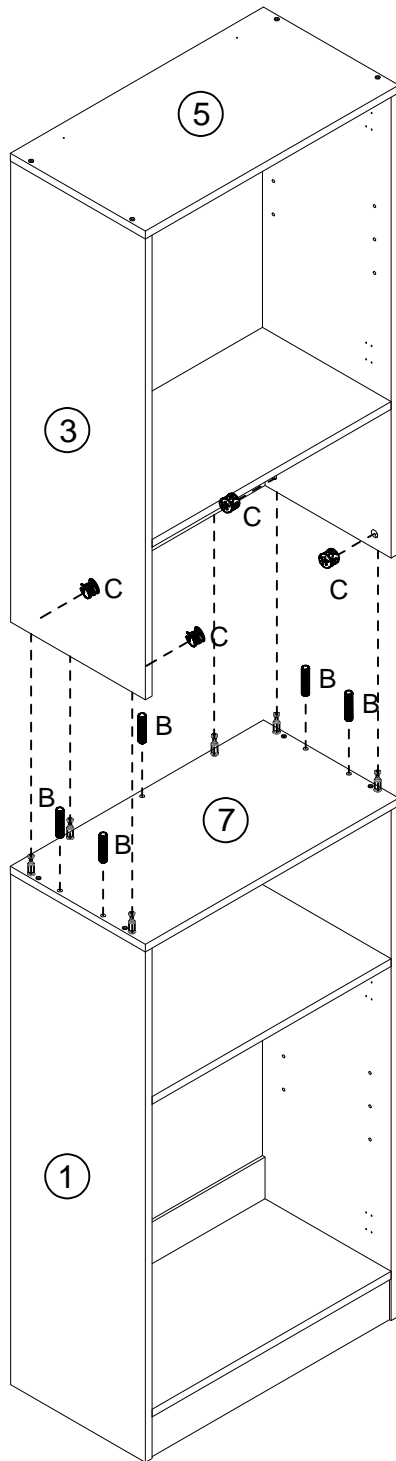
Step:15



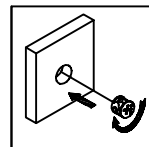

	B x 5PCS
	C x 6PCS

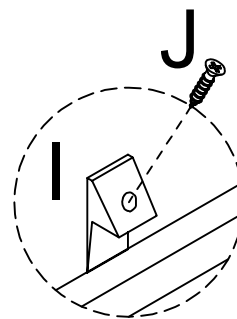
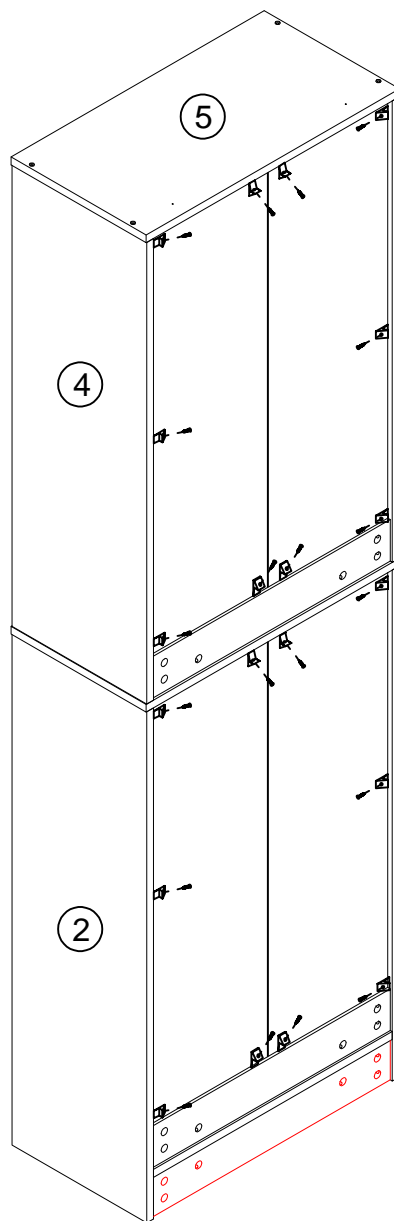

# Assembly Steps(EN) / Montageschritte(DE)

Step:16



	I x 20PCS
	J x 20PCS

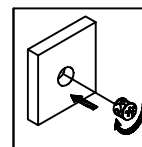

# Assembly Steps(EN) / Montageschritte(DE)

Step:17

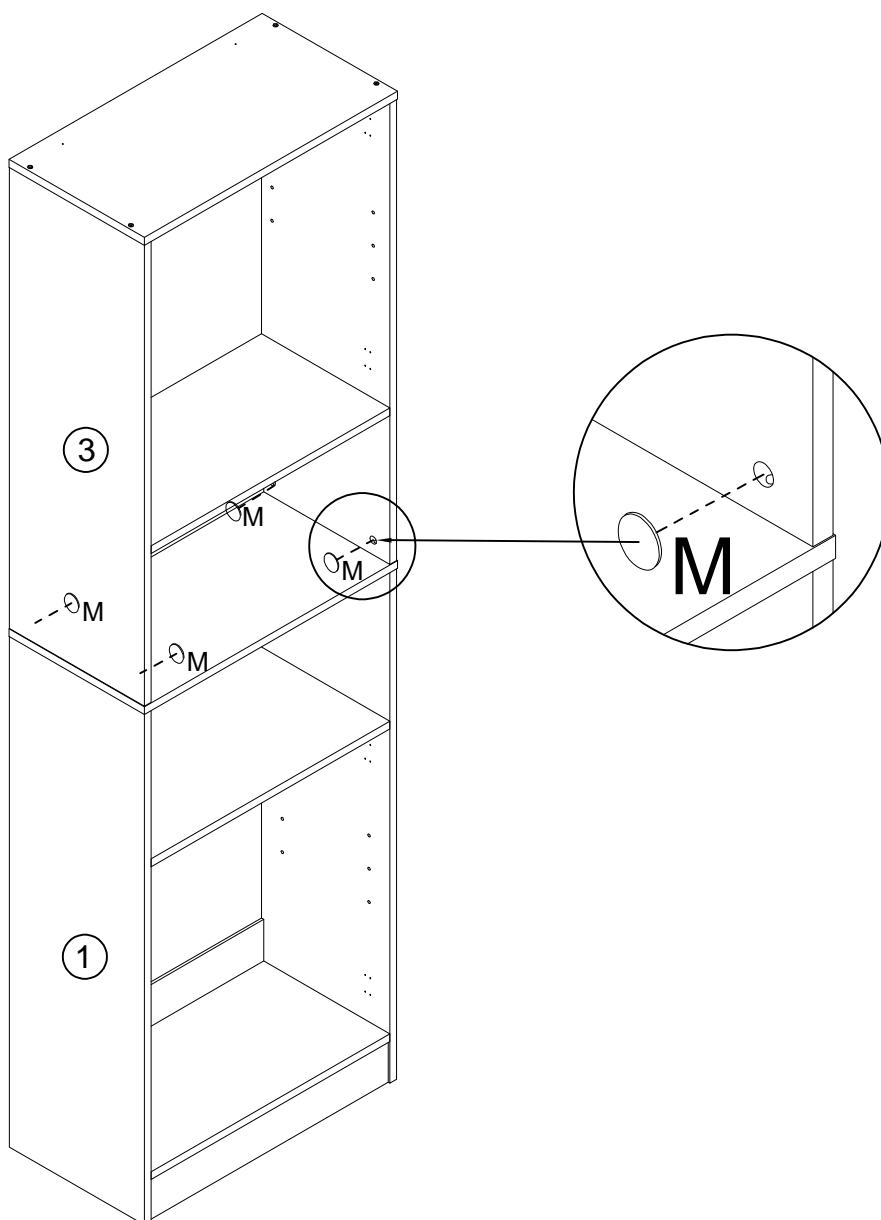

M x 4PCS

# Assembly Steps(EN) / Montageschritte(DE)



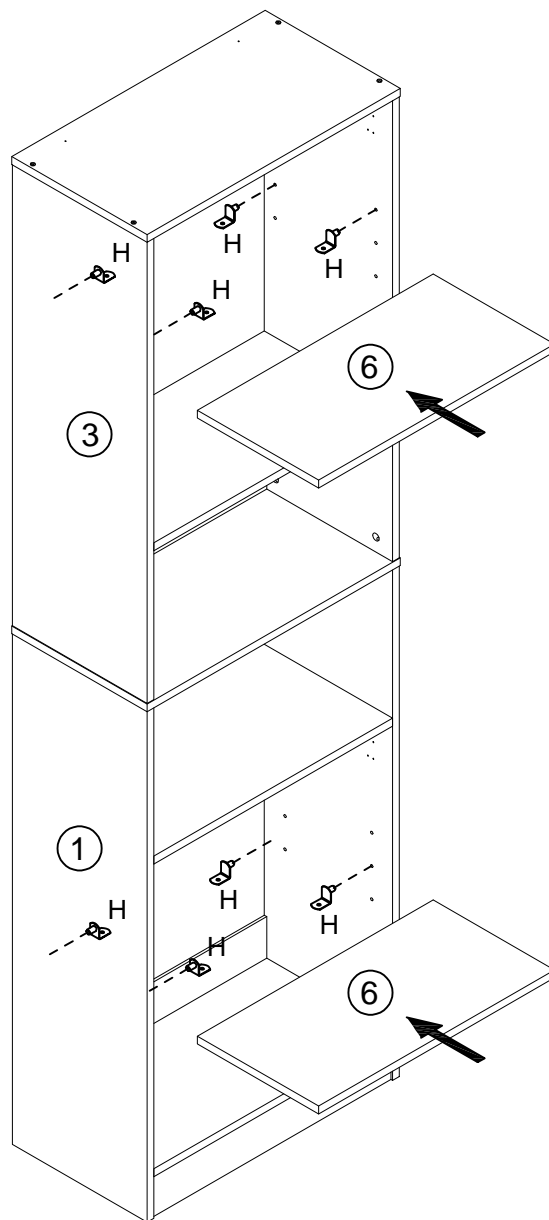

Step:18



H x 8PCS

# Assembly Steps(EN) / Montageschritte(DE)

Step:19

	D x 16PCS
	E x 8PCS
	F x 8PCS
	G x 4PCS

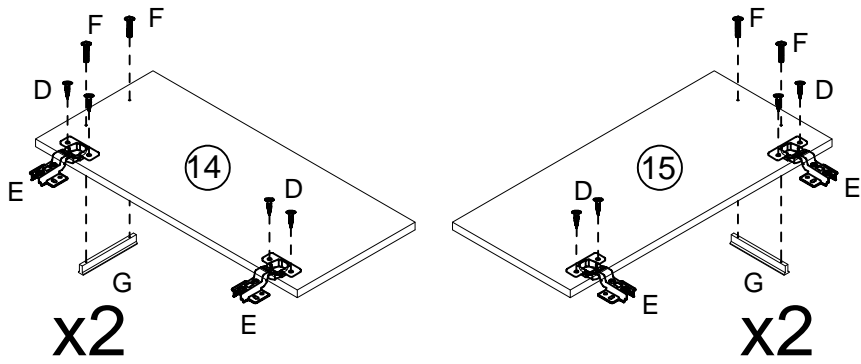

Step:20

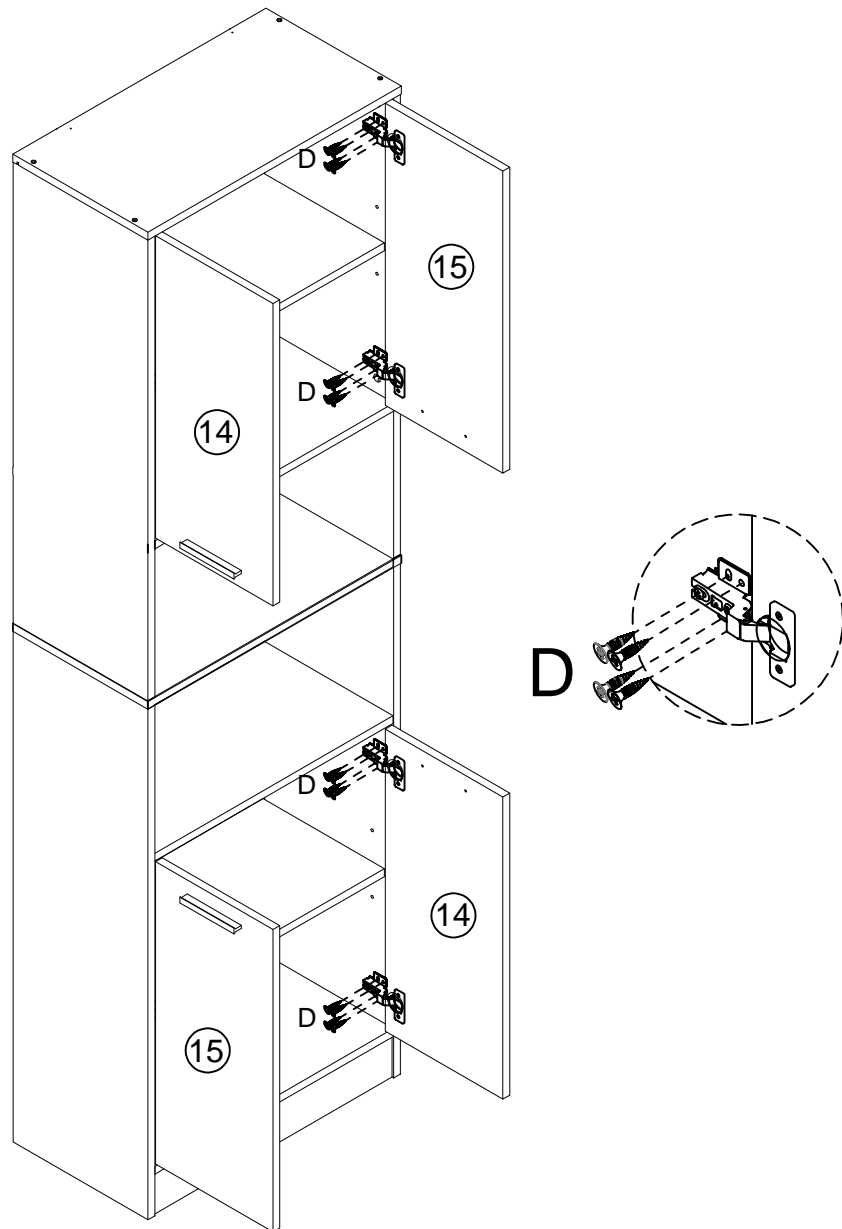



	D x 32PCS
---	-----------

# Assembly Steps(EN) / Montageschritte(DE)

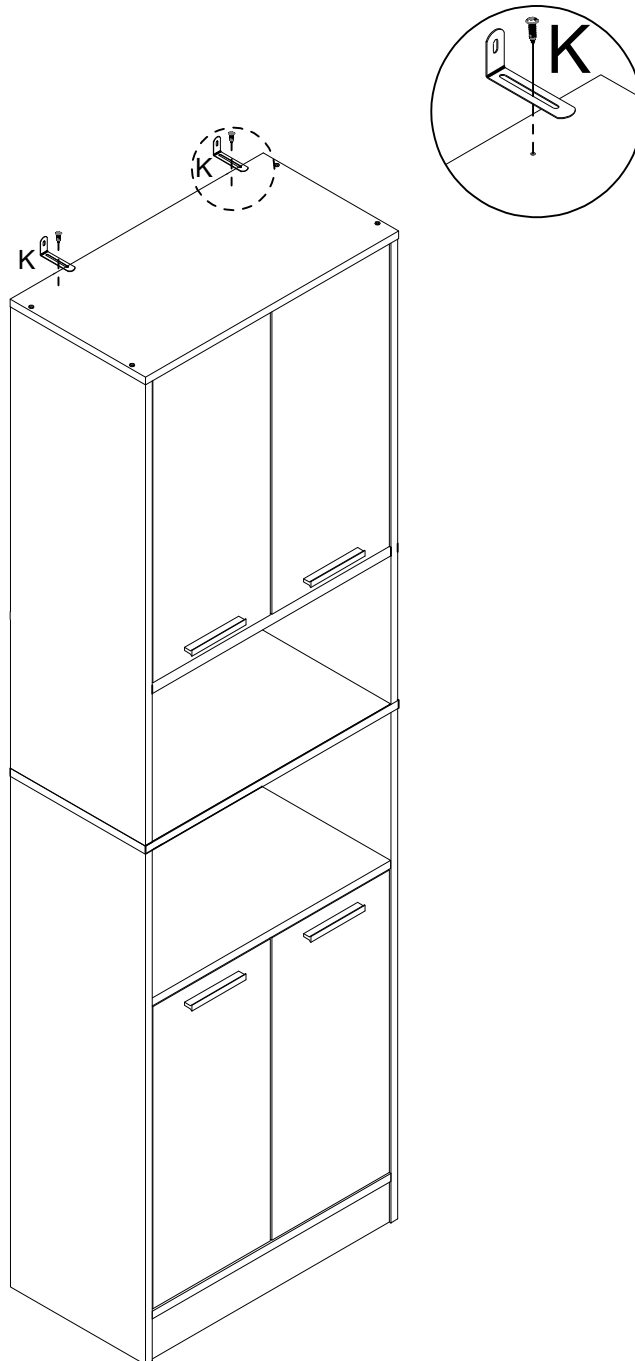
Step:21



	K x 2SETS
	

# Assembly Steps(EN) / Montageschritte(DE)

Step:22

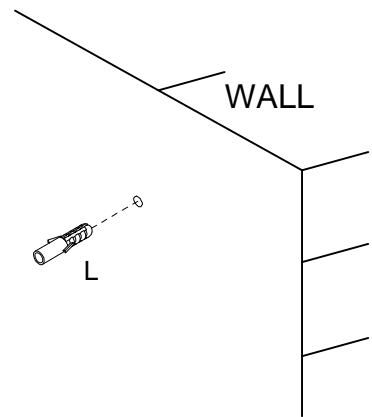
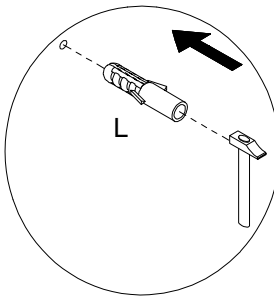
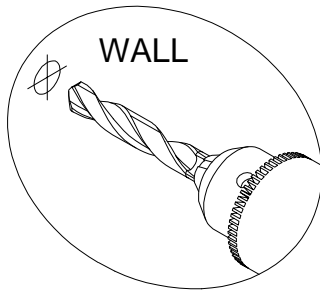

L x 2PCS

Step:23

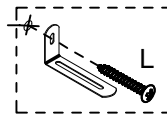
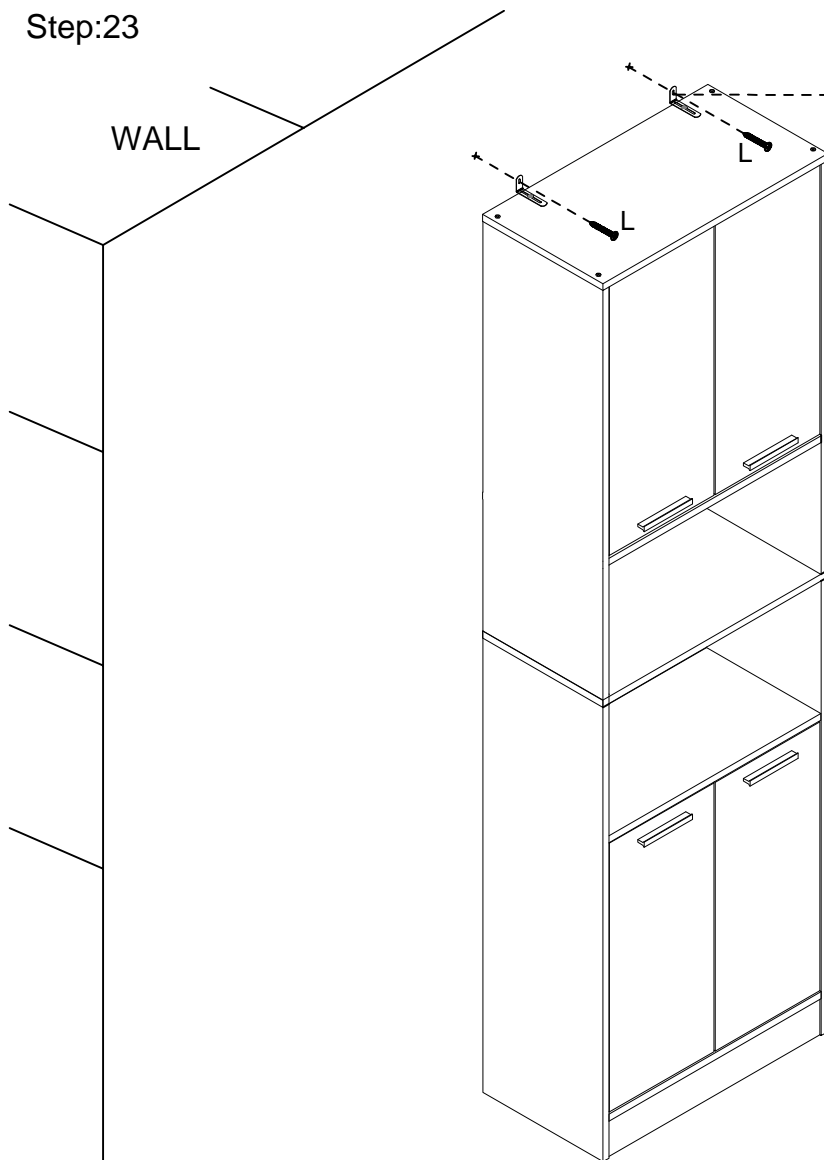

L x 2PCS

# Assembly Steps(EN) / Montageschritte(DE)

Step:24

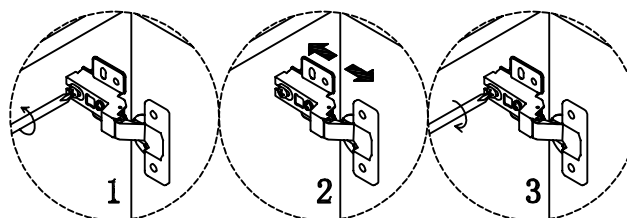
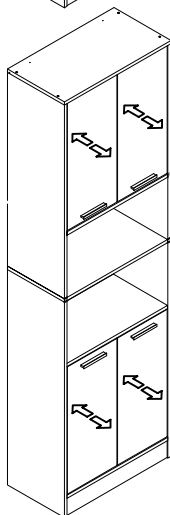
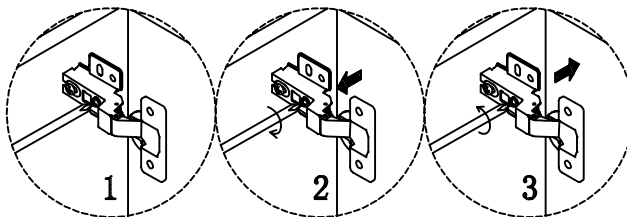
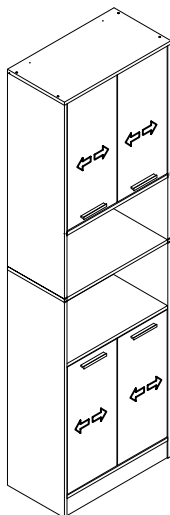
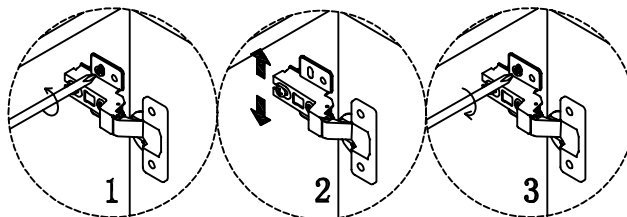
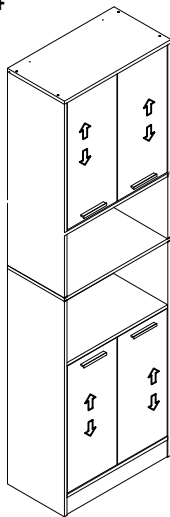



## WARNING



Children have died from furniture tipover. To reduce the risk of furniture tipover:

- **ALWAYS** install tipover restraint provided.
- **NEVER** allow children to stand, climb or hang on drawers, doors, or shelves.
- **NEVER** open more than one drawer at a time.
- **Place heaviest items in the lowest drawers.**