

# ASSEMBLY INSTRUCTION

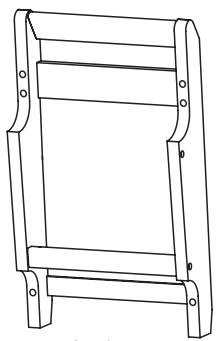

A\*1

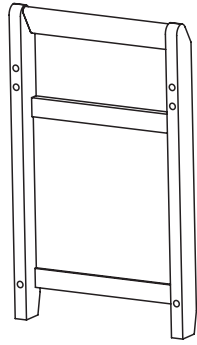

B\*1

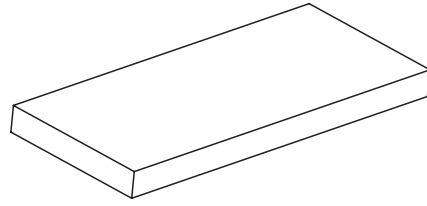

C\*1

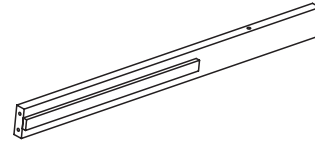

D\*2

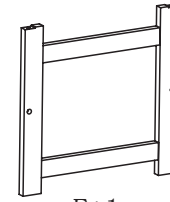

E\*1

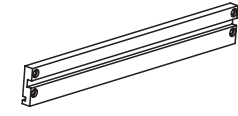

F\*2

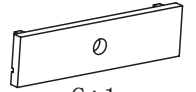

G\*1



H\*4



①\*14

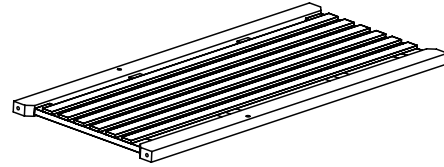

J\*1

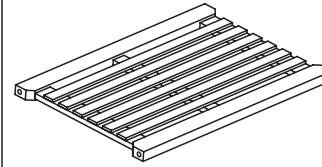

K\*1



M\*1

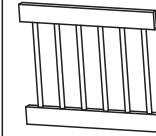

O\*1

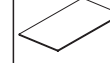

N\*1

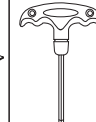

P\*1



②\*6



③\*8

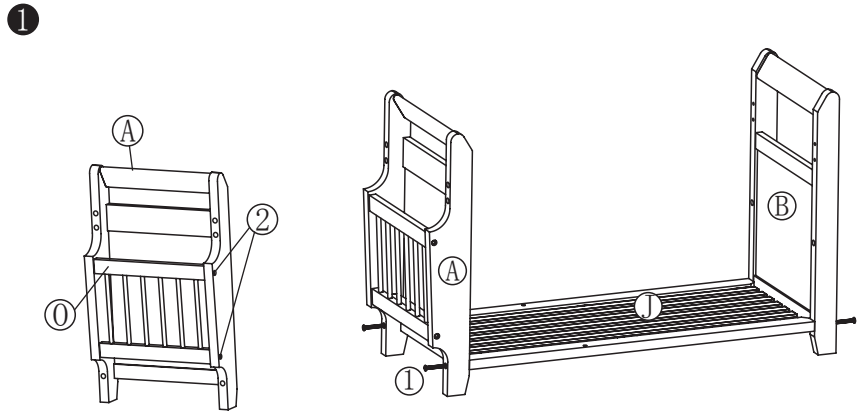

Please don't fix the screw tightly.

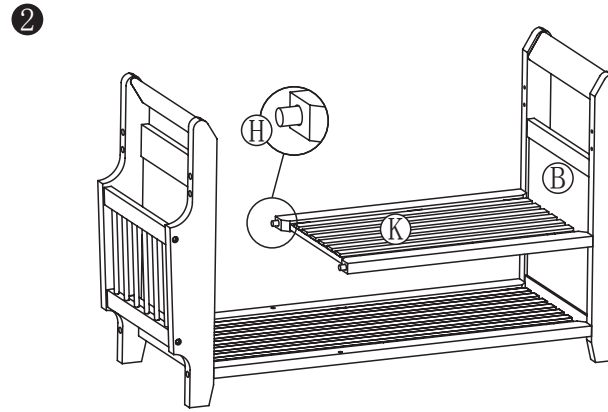

The direction is upside.

